



USFC2004-1609-08

{E320199A-1F28-41AD-813D-C6F980EC7955}

{61685}{05-050721:081250}{062705}

JOINT APPENDIX

04-1609, 05-1141,-1202

UNITED STATES COURT OF APPEALS FOR THE FEDERAL CIRCUIT

GOLDEN BLOUNT, INC.

Plaintiff-Appellee,

v.

ROBERT H. PETERSON CO.,

Defendant-Appellant.

RECEIVED

JUN 28 2005

United States Court of Appeals
For The Federal Circuit

APPEAL FROM THE UNITED STATES DISTRICT COURT FOR THE
NORTHERN DISTRICT OF TEXAS IN 3:01-CV-127-R

JUDGE JERRY BUCKMEYER

U.S. COURT OF APPEALS
FOR THE FEDERAL CIRCUIT

NON-CONFIDENTIAL JOINT APPENDIX

VOLUME VI, PAGES JT-APP 2427 – 2918

JUN 28 2005

U.S. COURT OF APPEALS
FOR THE FEDERAL CIRCUIT
CLERK

Leland W. Hutchinson, Jr.
Jennifer L. Fitzgerald
David S. Becker
FREEBORN & PETERS
Chicago, Illinois 60606
311 South Wacker Dr.,
Suite 3000
(312) 360-6000

Charles W. Gaines
Greg H. Parker
HITT GAINES, P.C.
2435 North Central Plaza,
Suite 1300
Richardson, Texas 75080
(972) 480-8800

William D. Harris, Jr.
SCHULTZ & ASSOCIATES
5400 LBJ Freeway
One Lincoln Center
Suite 525
Dallas, Texas 75240
(972) 789-1100

Attorneys for Defendant-
Appellant

Attorneys for Plaintiff-
Appellee

Attorneys for Plaintiff-
Appellee

TABLE OF CONTENTS

NOTE ON CONFIDENTIAL MATERIAL: Pursuant to Federal Circuit Rule 30(h)(1)(B), the parties hereby state that certain material has been redacted from this version of the Joint Appendix due its confidential nature. The material generally consists of proprietary sales and pricing data.

	Protective Order Issued by the United States District Court for the Northern District of Texas.....	JT-APP i-vi
1.	Minute Order Vacating Defendant's Findings of Fact and Conclusions of Law and Adopting Plaintiff's Findings of Fact and Conclusions of Law Dated August 18, 2005.....	JT-APP 0001
2.	Plaintiff-Appellee Golden Blount, Inc.'s Proposed Findings of Fact And Conclusions of Law Dated June 10, 2004.....	JT-APP 0002 – 0047
3.	Order Vacating Defendant's Findings of Fact and Conclusions of Law and Adopting Plaintiff's Findings of Fact and Conclusions of Law Consistent with the Court's August 18 Order Dated September 2, 2004	JT-APP 0048
4.	Order Vacating Defendant's Application for Attorneys' Consistent with the Court's August 18 Order Dated September 2, 2004.....	JT-APP 0049
5.	Findings of Fact and Conclusions of Law Dated September 2, 2004	JT-APP 0050 – 0082
6.	Order: Pursuant to the District Court's Order of Reference, entered September 16, 2004, Plaintiff's Applications are granted in part and denied in part. Dated November 15, 2004.....	JT-APP 0083 – 0093
7.	Final Judgment Dated December 15, 2004	JT-APP 0094

8.	Docket Sheet.....	JT-APP 0095 - 0108
9.	Plaintiff Golden Blount, Inc.'s Complaint for Patent Infringement and Jury Demand dated January 18, 2001	JT-APP 0109 - 0123
10.	Defendant Robert H. Peterson Co.'s Answer and Counterclaim dated March 19, 2001	JT-APP 0124 - 0127
11.	Plaintiff Golden Blount, Inc.'s Reply to Defendant's Counterclaim dated December 28, 2001	JT-APP 0128 - 0130
12.	Plaintiff Golden Blount, Inc.'s Pretrial Disclosure Pursuant to F.R.C.P. 26(a)(3) dated January 22, 2002	JT-APP 0131 - 0135
13.	Defendant Robert H. Peterson Co.'s Pretrial Disclosure List of Exhibits dated January 22, 2002.....	JT-APP 0136 - 0141
14.	Defendant Robert H. Peterson Co.'s Pretrial Disclosure List of Witnesses dated January 22, 2002.....	JT-APP 0142 - 0145
15.	Defendant Robert H. Peterson Co.'s Objections to Plaintiff's Pre-Trial Disclosure dated February 5, 2002	JT-APP 0146 - 0150
16.	Plaintiff Golden Blount, Inc.'s Objections to Defendant's Pre-Trial Disclosure dated February 5, 2002.....	JT-APP 0151 - 0154
17.	Defendant Robert H. Peterson Co.'s List of Exhibits dated February 20, 2002.....	JT-APP 0155 - 0161

18.	Defendant Robert H. Peterson Co.'s List of Witnesses dated February 20, 2002	JT-APP 0162 – 0165
19.	Plaintiff Golden Blount, Inc.'s Pretrial Materials dated February 20, 2002	JT-APP 0166 – 0286
20.	Joint Pretrial Order Pursuant to Local Rule 16.4 dated February 20, 2002	JT-APP 0287 – 0311
21.	Plaintiff Golden Blount, Inc.'s Response to Defendant Peterson Co.'s Motion to Preclude Testimony of F. William McLaughlin Dated March 15, 2002	JT-APP 0312 – 0318
22.	Plaintiff Golden Blount, Inc.'s Findings of Fact and Conclusions of Law Dated April 19, 2002	JT-APP 0319 – 0328
23.	Defendant Robert H. Peterson Co.'s Proposed Findings of Fact and Conclusions of Law Dated April 19, 2002	JT-APP 0329 - 0345
24.	Plaintiff Golden Blount, Inc.'s Issue Directed Trial Brief dated April 19, 2002	JT-APP 0346 – 0356
25.	Plaintiff Golden Blount, Inc.'s Substitute List of Exhibits dated April 19, 2002	JT-APP 0357 – 0361
26.	Supplemental Joint Pretrial Order Pursuant to Local Rule 16.4 dated April 22, 2002	JT-APP 0362 – 0371
27.	Plaintiff Golden Blount, Inc.'s Opening Claim Construction Brief dated May 20, 2002	JT-APP 0372 – 0426
28.	Defendant Robert H. Peterson Co.'s Responding Brief Regarding Claim Construction dated May 28, 2002	JT-APP 0427 - 0445
29.	Plaintiff Golden Blount, Inc.'s Reply to Defendant Robert H. Peterson Co.'s	

	Responsive Claim Construction Brief dated June 3, 2002	JT-APP 0446 – 0459
30.	Order Denying Peterson Co.’s Motion for Protective Order dated June 4, 2002	JT-APP 0460
31.	Defendant Robert H. Peterson Co.’s 35 USC Section 282 Notice dated June 26, 2002	JT-APP 0461 – 0463
32.	Plaintiff Golden Blount, Inc.’s Designation of Additional Exhibits; Exhibits 1-7 dated July 25, 2002.....	JT-APP 0464 – 0511
33.	Plaintiff Golden Blount Inc.’s Motion to Disregard the Testimony of John Palaski and Brief in Support Thereof dated July 31, 2002.....	JT-APP 0512 – 0517
34.	Final Judgment dated August 9, 2002	JT-APP 0518
35.	Findings of Fact and Conclusions of Law dated August 9, 2002.....	JT-APP 0519 – 0527
36.	Order Costs taxing in the amount of \$10,031.04 for Plaintiff Golden Blount, Inc. dated August 27, 2002	JT-APP 0528
37.	Order dated February 7, 2003.....	JT-APP 0529 – 0530
38.	Order Awarding Damages dated March 7, 2003.....	JT-APP 0531

39.	Defendant Robert H. Peterson Co.'s Motion for Leave to File Under Seal First Motion to Amend Findings of Fact, Conclusions of Law and Judgment in Accordance with Rule 52(b) Federal Rules of Civil Procedure dated August 23, 2002.....	JT-APP 0532 – 0534
40.	Defendant Robert H. Peterson Co.'s First Motion to Amend Findings of Fact, Conclusions of Law and Judgment in Accordance with Rule 52(b) Federal Rules of Civil Procedure dated August 23, 2002.....	JT-APP 0535 – 0537
41.	Defendant Robert H. Peterson Co.'s Memorandum in Support of First Motion to Amend Findings of Fact, Conclusions of Law and Judgment in Accordance with Rule 52(b) Federal Rules of Civil Procedure dated August 23, 2002.....	JT-APP 0538 – 0551
42.	Defendant Robert H. Peterson Co.'s Second Motion to Amend Findings of Fact, Conclusions of Law and Judgment Under Rule 52(b), or, for New Trial Under Rule 59(a), Federal Rules of Civil Procedure dated August 23, 2002.....	JT-APP 0552 – 0554
43.	Defendant Robert H. Peterson Co.'s Memorandum of Law in Support of Second Motion Under Rules 52(b) and 59(a), Federal Rules of Civil Procedure dated August 23, 2002.....	JT-APP 0555 – 0588
44.	Plaintiff Golden Blount, Inc.'s Motion and Brief to Include Updated Damages and Pre and Post Judgment Interest dated August 27, 2002	JT-APP 0589 – 0595

45.	Plaintiff Golden Blount, Inc.’s Application for Attorney’s Fees dated August 27, 2002	JT-APP 0596 – 0599
46.	Plaintiff Golden Blount, Inc.’s Memorandum in Support of Application for Attorney’s Fees dated August 27, 2002	JT-APP 0600 – 0617
47.	Plaintiff Golden Blount, Inc.’s Appendix in Support of Application for Attorney’s Fees dated August 27, 2002	JT-APP 0618 – 0695
48.	Plaintiff Golden Blount Inc.’s Bill of Costs dated August 27, 2002	JT-APP 0696 – 0767
49.	Plaintiff Golden Blount Inc.’s Reply to Defendant Robert H. Peterson Company’s Opposition to Plaintiff’s Motion to Disregard the Testimony of John Palaski dated August 27, 2002.....	JT-APP 0768 – 0771
50.	Defendant Robert H. Peterson Co.’s Objections to Plaintiff’s Claim for Attorney’s Fees dated September 19, 2002	JT-APP 0772 – 0792
51.	Defendant Robert H. Peterson Co.’s Objection to Golden Blount’s Motion for Updated Damages dated September 19, 2002	JT-APP 0793 – 0803
52.	Plaintiff Golden Blount, Inc.’s Response to Peterson Company’s Second Motion to Amend Findings of Fact, Conclusions of Law and Judgment Under Rule 52(b), or, for New Trial Under Rule 59(a), Federal Rules of Civil Procedure dated September 19, 2002 ...	JT-APP 0804 – 0820
53.	Plaintiff Golden Blount, Inc.’s Response to Peterson Company’s First Motion to Amend Findings of Fact, Conclusions of Law and Judgment in Accordance with Rule 52(b) Federal Rules of Civil Procedure dated September 23, 2002	JT-APP 0821 – 0823

54.	Plaintiff Golden Blount, Inc.’s Reply to Defendant Peterson Company’s Objection to Golden Blount Inc.’s Motion for Updated Damages dated October 4, 2002	JT-APP 0824 – 0834
55.	Plaintiff Golden Blount, Inc.’s Reply to Defendant Peterson Company’s Objection to Golden Blount Inc.’s Claim for Attorneys’ Fees dated October 4, 2002	JT-APP 0835 – 0867
56.	Defendant Robert H. Peterson Co.’s Reply Brief in Support of its Second Motion to Amend Findings of Fact, Conclusions of Law, and Judgment Under Rule 52(b), or, For New Trial Under Rule 59(a), Federal Rules of Civil Procedure dated October 4, 2002.....	JT-APP 0868 - 0899
57.	Defendant Robert H. Peterson Co.’s Response to Order of February 6, 2003 dated February 24, 2003.....	JT-APP 0900 - 0902
58.	Plaintiff Golden Blount, Inc.’s Notice to the Court that Defendant Peterson Company’s Response to the Court Order of February 6, 2003 Contains Volunteered and Non-Responsive Information dated February 28, 2003	JT-APP 0903 – 0905
59.	Defendant Robert H. Peterson Co.’s Notice of Appeal to Fed. Cir. dated March 6, 2003	JT-APP 0906 - 0919
60.	Defendant Robert H. Peterson Co.’s Amended Notice of Appeal dated March 18, 2003	JT-APP 0920 – 0933
61.	Transcript of Trial before the Honorable Jerry Buckmeyer Volume 1 of 3 dated July 29, 2002.....	JT-APP 0934 – 1145
62.	Transcript of Trial before the Honorable Jerry Buckmeyer Volume 2 of 3 dated July 30, 2002.....	JT-APP 1146 – 1391
63.	Transcript of Trial before the Honorable Jerry Buckmeyer Volume 3 of 3 dated July 31, 2002.....	JT-APP 1392 – 1478

64.	Plaintiff Trial Exhibit 1 - U.S. Patent 5,988,159 dated November 23, 1999	JT-APP 1479 – 1486
65.	Plaintiff Trial Exhibit 2a – Golden Blount Log Set With Secondary Coals Burner	JT-APP 1487
66.	Plaintiff Trial Exhibit 2b - Golden Blount Log Set Without Secondary Coals Burner.....	JT-APP 1488
67.	Plaintiff Trial Exhibit 3a – Golden Blount Coals Burner Assembly and Grate	JT-APP 1489
68.	Plaintiff Trial Exhibit 3b – Golden Blount Logs.....	JT-APP 1490
69.	Plaintiff Trial Exhibit 4a - Peterson Coals Burner Assembly and Grate	JT-APP 1491
70.	Plaintiff Trial Exhibit 4b - Peterson Logs	JT-APP 1492
71.	Plaintiff Trial Exhibit 5a - Peterson Log Set with Ember Flame Booster.....	JT-APP 1493
72.	Plaintiff Trial Exhibit 5b - Peterson Log Set Without Ember Flame Booster.....	JT-APP 1494
73.	Plaintiff Trial Exhibit 6 – Marketing material for Peterson Ember Flame Booster.....	JT-APP 1495
74.	Plaintiff Trial Exhibit 7 – Real-Fyre Ember Flame Booster Installation and Operating Instructions	JT-APP 1496 – 1499
75.	Plaintiff Trial Exhibit 8 - Golden Blount Video of Golden Blount’s and Peterson’s Log Burning Set	JT-APP 1500
76.	Plaintiff Trial Exhibit 9 - Literal Infringement Chart	JT-APP 1501 – 1512

77.	Plaintiff Trial Exhibit 10 – Letter dated December 10, 1999 from L. Dan Tucker to Peterson Company regarding marketing of a substantially similar device to Golden Blount’s patented device.....	JT-APP 1513
78.	Plaintiff Trial Exhibit 11 – Letter dated December 30, 1999 from Tod Corrin to L. Dan Tucker regarding acknowledgement of receipt of December 10, 1999 letter	JT-APP 1514 – 1515
79.	Plaintiff Trial Exhibit 12 – Letter dated May 3, 2000 from L. Dan Tucker to Tod Corrin forwarding copy of U.S. Patent 5,988,159	JT-APP 1516
80.	Plaintiff Trial Exhibit 13 – Letter dated May 16, 2000 from Terrell Stone to L. Dan Tucker responding to May 3, 2000 letter	JT-APP 1517
81.	Plaintiff Trial Exhibit 14 – Letter dated January 19, 2001 from Roy Hardin to Tod Corrin regarding infringement of U.S. Patent 5,988,159	JT-APP 1518 - 1519
82.	Plaintiff Trial Exhibit 15a - Golden Blount Item Ledgercards	JT-APP 1520 - 1595
83.	Plaintiff Trial Exhibit 15b – Chart regarding CEBB Sales from February 1, 2002 – May 1, 2002	JT-APP 1596
84.	Plaintiff Trial Exhibit 16 – Handwritten Table regarding pricing.....	JT-APP 1597
85.	Plaintiff Trial Exhibit 17 – Chart regarding Ember Booster Sales for Peterson Company	JT-APP 1598 - 1601

86.	Plaintiff Trial Exhibit 18 – Chart regarding Sales Price to Golden Blount	JT-APP 1602
87.	Plaintiff Trial Exhibit 20 – Chart regarding Claim Interpretation Chart for U.S. Patent No. 5,988,159.....	JT-APP 1603 – 1608
88.	Plaintiff Trial Exhibit 21 – Equivalence Chart.....	JT-APP 1609 – 1625
89.	Plaintiff Trial Exhibit 22 – Chart of Centerline, Top, and Bottom Tests	JT-APP 1626 – 1627
90.	Plaintiff Trial Exhibit 23 - Peterson Real-Fyre Gas Logs & Replace Accessories Price List	JT-APP 1628 – 1633
91.	Plaintiff Trial Exhibit 24 & 24a - Deposition and Confidential Portions of Leslie Bortz Volume 1 taken October 5, 2001.....	JT-APP 1634 – 1833
92.	Plaintiff's Trial Exhibit 25 - Deposition of Leslie Bortz Volume 2 taken December 19, 2001	JT-APP 1834 - 1903
93.	Plaintiff's Trial Exhibit 26 - Deposition Transcript of F. William McLaughlin taken December 19, 2001	JT-APP 1904 - 1985
94.	Defendant Trial Exhibit 1 - U.S. Patent 5,988,159 dated November 23, 1999.....	JT-APP 1986 - 1993
95.	Defendant Trial Exhibit 2 - Patent Application dated May 17, 1993	JT-APP 1994 - 2029
96.	Defendant Trial Exhibit 3 - Patent Application dated April 19, 1994	JT-APP 2030 - 2129
97.	Defendant Trial Exhibit 4 - Patent Application dated April 2, 1996.....	JT-APP 2130 - 2205
98.	Defendant Trial Exhibit 5 – U.S. Patent 3,042,109 dated July 3, 1962.....	JT-APP 2206 - 2209

99.	Defendant Trial Exhibit 6 – U.S. Patent 3,871,355 dated March 18, 1975	JT-APP 2210 - 2214
100.	Defendant Trial Exhibit 7 – U.S. Patent 5,000,162 dated March 19, 1991	JT-APP 2215 - 2225
101.	Defendant Trial Exhibit 8 - U.S. Patent 5,033,455 dated July 23, 1991	JT-APP 2226 - 2231
102.	Defendant Trial Exhibit 9 - U.S. Patent 5,052,370 dated October 1, 1991.....	JT-APP 2232 - 2241
103.	Defendant Trial Exhibit 10 - U.S. Patent 5,081,981 dated January 21, 1992	JT-APP 2242 - 2253
104.	Defendant Trial Exhibit 11 - U.S. Patent 5,263,852 dated November 23, 1993.....	JT-APP 2254 - 2258
105.	Defendant Trial Exhibit 12 - U.S. Patent 3,583,845 dated June 8, 1971	JT-APP 2259 - 2262
106.	Defendant Trial Exhibit 16 - Letter dated December 17, 1999, from L. Dan Tucker to Peterson Company regarding marketing of a substantially similar device to Golden Blount’s patented device.....	JT-APP 2263
107.	Defendant Trial Exhibit 17 - Letter dated December 17, 1999 from Tod Corrin to F. William McLaughlin transmitting patent infringement letter.....	JT-APP 2264
108.	Defendant Trial Exhibit 18 – Letter dated December 30, 1999 from Tod Corrin to L. Dan Tucker regarding acknowledgment of receipt of December 10, 1999 letter.....	JT-APP 2265 - 2266

109.	Defendant Trial Exhibit 19 – Letter dated May 3, 2000 from L. Dan Tucker to Tod Corrin regarding U.S. Patent 5,988,159	JT-APP 2267
110.	Defendant Trial Exhibit 20 - Letter dated March 16, 2000 from Terrell Stone to L. Dan Tucker responding to May 3, 2000 letter.....	JT-APP 2268
111.	Defendant Trial Exhibit 21 – Letter dated January 19, 2001 from Roy Hardin to Tod Corrin regarding infringement of U.S. Patent 5,988,159	JT-APP 2269 - 2270
112.	Defendant Trial Exhibit 22 – Letter dated February 9, 2001 from Leslie Bortz to F. William McLaughlin enclosing documents regarding the lawsuit.....	JT-APP 2271 - 2278
113.	Defendant Trial Exhibit 23 - Fax dated March 16, 2001 from Leslie Bortz to Bill McLaughlin attaching documents.....	JT-APP 2279 – 2294
114.	Defendant Trial Exhibit 25 – Peterson Real-Fyre Gas Log Sets & Fireplace Accessories Price List	JT-APP 2295 - 2300
115.	Defendant Trial Exhibit 26 - Peterson Front Flame Director (FD-Series) Installation Instructions.....	JT-APP 2301
116.	Defendant Trial Exhibit 29 - Golden Blount EMB G4 Reference #2 diagram.....	JT-APP 2302 - 2304
117.	Defendant Trial Exhibit 30 - Golden Blount EMB G4 Reference #2 diagram.....	JT-APP 2305
118.	Defendant Trial Exhibit 33 - Peterson Real-Fyre Ember Flame Booster Manual.....	JT-APP 2306 - 2311

119.	Defendant Trial Exhibit 34 - Peterson Real-Fyre Ember Flame Booster Installation and Operating Instructions	JT-APP 2312 – 2315
120.	Defendant Trial Exhibit 35 – Picture of Peterson Burner Assembly	JT-APP 2316
121.	Defendant Trial Exhibit 43 – Hook Up for Circular G4 Burners handwritten notes.....	JT-APP 2317
122.	Defendant Trial Exhibit 44 - Peterson Quiet Burner Operating Instructions	JT-APP 2318
123.	Defendant Trial Exhibit 45 - Real-Fyre Hearth Logs with Front-Flame Burner Installation Instructions.....	JT-APP 2319
124.	Defendant Trial Exhibit 46 – Peterson Burner Diagram	JT-APP 2320
125.	Defendant Trial Exhibit 47 - Peterson Burner Assembly Diagram	JT-APP 2321
126.	Defendant Trial Exhibit 48 - Peterson Burner Assembly Diagram	JT-APP 2322
127.	Defendant Trial Exhibit 49 - Peterson Real-Fyre Gas Fireplace Log Sets & Accessories Price List.....	JT-APP 2323 - 2326
128.	Defendant Trial Exhibit 50 - Real-Fyre Auxiliary Valves and Burner Parts marketing material.....	JT-APP 2327
129.	Defendant Trial Exhibit 51 - Real-Fyre F3 Series Circular Burner marketing material.....	JT-APP 2328
130.	Defendant Trial Exhibit 52 - Peterson Real-Fyre marketing materials.....	JT-APP 2329 - 2340

131.	Defendant Trial Exhibit 53 - Peterson Ember Booster Sales Chart	JT-APP 2341 - 2343
132.	Defendant Trial Exhibit 54 - Single Level Engineering Bills of Material Chart	JT-APP 2344
133.	Defendant Trial Exhibit 55 - Peterson Real-Fyre Gas Logs marketing material.....	JT-APP 2345
134.	Defendant Trial Exhibit 56 - Declaration of John Palaski dated October 23, 2001	JT-APP 2346 -- 2348
135.	Defendant Trial Exhibit 57 - Declaration of Darryl R. Dworkin dated October 23, 2001	JT-APP 2349 - 2353
136.	Defendant Trial Exhibit 58 - Complaint for Infringement and Jury Demand dated January 18, 2001.....	JT-APP 2354 - 2368
137.	Defendant Trial Exhibit 59 - Answer and Counterclaim dated March 19, 2003	JT-APP 2369 -- 2372
138.	Defendant Trial Exhibit 60 - Plaintiff's Reply to Defendant's Counterclaim dated December 28, 2001	JT-APP 2373 - 2375
139.	Defendant Trial Exhibit 61 - Defendant's Answers to Plaintiff Golden Blount, Inc.'s First Set of Interrogatories	JT-APP 2376 -- 2386
140.	Defendant Trial Exhibit 62 - Defendant's Responses to Plaintiff Golden Blount, Inc.'s First Set of Document Requests.....	JT-APP 2387 -- 2395
141.	Defendant Trial Exhibit 63 - Plaintiff Golden Blount, Inc.'s Response to Defendant's First of Document Requests Dated January 22, 2001	JT-APP 2396 - 2414

142.	Defendant Trial Exhibit 64 - Plaintiff Golden Blount, Inc.'s Answers and Objections to Defendant's First Set of Interrogatories Dated June 22, 2001	JT-APP 2415 - 2426
143.	Judgment: It is Ordered and Adjudged: Affirmed-In-Part, Vacated-In-Part, And Remanded Dated May 17, 2004	JT-APP 2427
144.	Opinion of Appellate Court Dated May 17, 2004	JT-APP 2428 - 2444
145.	Order For Parties To Submit Proposed Findings Of Fact And Conclusions Of Law On The Issues Of Literal Infringement, Contributory Infringement, Induced Infringement, Infringement Under The Doctrine Of Equivalents, Willfulness, The Exceptional Nature Of The Case And Damages Dated May 11, 2004	JT-APP 2445
146.	Defendant-Appellant Robert H. Peterson, Co.'s Proposed Findings of Fact and Conclusions of Law Dated June 10, 2004	JT-APP 2446 - 2509
147.	Order Adopting Defendant Robert H. Peterson's Proposed Findings of Fact and Conclusions of Law Dated June 22, 2004	JT-APP 2510
148.	Plaintiff Golden Blount, Inc.'s Request For Reconsideration of Adoption of Defendant's Findings of Fact And Conclusions of Law, Alternative Motion For New Trial And Request For Oral Hearing Dated July 6, 2004	JT-APP 2511 - 2512
149.	Plaintiff Golden Blount, Inc.'s Motion to Amend its Findings of Fact And Conclusions of Law Dated July 6, 2004	JT-APP 2513 - 2514

150.	Plaintiff Golden Blount Inc.’s Brief Supporting Request For Reconsideration of Adoption of Defendant’s Findings of Fact And Conclusions of Law, Alternative Motion for New Trial And Request For Oral Hearing Dated July 6, 2004	JT-APP 2515 – 2553
151.	Order Setting Hearing Date on Plaintiff Golden Blount’s, Inc.’s Motion to Amend its Findings of Fact and Conclusions of Law Dated July 8, 2004.....	JT-APP 2554
152.	Defendant Robert H. Peterson, Co.’s Application For Attorneys’ Fees Dated July 22, 2004	JT-APP 2555 – 2560
153.	Defendant Robert H. Peterson’s Memorandum in Support of Application For Attorney’s Fees Dated July 22, 2004.....	JT-APP 2561 – 2568
154.	Declaration of Jerry R. Selinger in Support of Defendant Robert H. Peterson’s Application for Attorneys’ Fees Dated July 22, 2004.....	JT-APP 2569 – 2670
155.	Declaration of F. William McLaughlin in Support of Defendant Robert H. Peterson’s Application For Attorneys’ Fees Dated July 22, 2004.....	JT-APP 2671 – 2754
156.	Declaration of Leland W. Hutchinson, Jr. in Support of Defendant Robert H. Peterson’s Application For Attorneys’ Fees Dated July 22, 2004.....	JT-APP 2755 – 2830
157.	Defendant Robert H. Peterson Co.’s Opposition to Plaintiff’s Motions to Amend Findings, For Reconsideration and For a New Trial Dated July 23, 2004	JT-APP 2831 – 2868
158.	Order Resetting the Hearing on Plaintiff’s Motion to Amend Its Findings of Fact and Conclusions of Law for August 18, 2004 Dated July 23, 2004.....	JT-APP 2869

159.	Plaintiff Golden Blount, Inc.'s Reply to Defendant's Opposition to Amend Findings, For Reconsideration And For a New Trial Dated August 9, 2004	JT-APP 2870 – 2883
160.	Order Granting Defendant Robert H. Peterson, Co.'s Application for Attorney's Fees Dated August 11, 2004	JT-APP 2884
161.	Plaintiff Golden Blount's Proposed Findings of Fact and Conclusions of Law Dated August 31, 2004.....	JT-APP 2885 – 2918
162.	Plaintiff Golden Blount, Inc.'s Application for Attorneys' Fees Dated September 8, 2004	JT-APP 2919 – 2925
163.	Plaintiff Golden Blount, Inc.'s Memorandum in Support of Its Application For Attorneys' Fees Dated September 8, 2004	JT-APP 2926 – 2944
164.	Plaintiff Golden Blount, Inc.'s Appendix in Support of Its Application For Attorney's Fees Dated September 8, 2004	JT-APP 2945 – 3059
165.	Plaintiff- Golden Blount, Inc.'s Application For Costs Dated September 9, 2004	JT-APP 3060 – 3063
166.	Order Referring Plaintiff Golden Blount, Inc.'s Motion for Attorney's Fees and Application for Costs to Magistrate Judge Stickney Dated September 16, 2004.....	JT-APP 3064
167.	Defendant Robert H. Peterson, Co.'s Notice of Appeal Dated September 17, 2004	JT-APP 3065 – 3103
168.	Defendant Robert H. Peterson, Co.'s Opposition to Plaintiff's Applications For Attorneys' Fees And Costs Dated September 17, 2004	JT-APP 3104 – 3114
169.	Plaintiff Golden Blount, Inc.'s Reply to Defendant's Opposition to Plaintiff's Application For Attorneys' Fees And Costs And Objection to Defendant's Untimely Filing of Notice of Appeal Dated September 23, 2004.....	JT-APP 3115 – 3120

170.	Transcript of Oral Arguments Before the Honorable Jerry Buchmeyer Dated August 18, 2004.....	JT-APP 3121 – 3185
171.	Plaintiff Golden Blount, Inc.’s Bill of Costs Dated November 15, 2004.....	JT-APP 3186 – 3257
172.	Plaintiff Golden Blount, Inc.’s Submission of Final Judgment And Order Dismissing Remaining Pending Motions Dated December 8, 2004.....	JT-APP 3258 – 3262
173.	Defendant Robert H. Peterson, Co.’s Notice of Appeal Dated December 9, 2004.....	JT-APP 3263 – 3315
174.	Dismissal of Remaining Pending Motions Dated December 15, 2004.....	JT-APP 3316
175.	Defendant Robert H. Peterson, Co.’s Notice of Appeal Dated January 14, 2005.....	JT-APP 3317 – 3367
176.	Order From the United States Court of Appeals for the Federal Circuit Consolidating Defendant’s Second and Third Appeals Dated January 27, 2005.....	JT-APP 3368
177.	Order From the United States Court of Appeals for the Federal Circuit Denying Golden Blount, Inc.’s Motion for Reconsideration, Vacation, or Modification of the Court’s February 15, 2005 Order Dated March 29, 2005.....	JT-APP 3369
178.	Order from the United States Court of Appeals for the Federal Circuit Denying Plaintiff’s Motion to Dismiss Defendant’s First Appeal, Granting Defendant’s Motion to Consolidate its First Appeal with the Consolidated Appeal, Granting Defendant’s Motion for an Extension of Time to File its Appellate Brief, and Denying Defendant’s Motion for a Stay as Moot Dated February 15, 2004.....	JT-APP 3370- 3372

179. Brief of Plaintiff-Appellee Golden Blount, Inc. (Corrected)
Dated June 30, 2003 JT-APP 3373 -
3445

Doc #827599

R
United States Court of Appeals for the Federal Circuit

03-1298

GOLDEN BLOUNT, INC.,

Plaintiff-Appellee,

v.

ROBERT H. PETERSON CO.,

Defendant-Appellant.

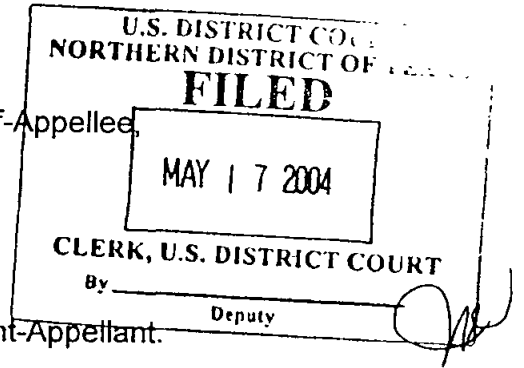

Judgment

ON APPEAL from the United States District Court for the Northern District of Texas

In CASE NO(S). 3:01-CV-0127-R

This CAUSE having been heard and considered, it is

ORDERED and ADJUDGED:

AFFIRMED-IN-PART, VACATED-IN-PART, AND REMANDED

ENTERED BY ORDER OF THE COURT

DATED APR 19 2004

Jan Horbaly
Jan Horbaly, Clerk

ISSUED AS A MANDATE: MAY 10, 2004

CERTIFIED COPY
I HEREBY CERTIFY THIS DOCUMENT
IS A TRUE AND CORRECT COPY
OF THE ORIGINAL ON FILE.
UNITED STATES COURT OF APPEALS
FOR THE FEDERAL CIRCUIT
By Shera Nims Date: 5-10-04

JT-APP 2427

United States Court of Appeals for the Federal Circuit

03-1298

3:01CV127-R

GOLDEN BLOUNT, INC.,

Plaintiff-Appellee

v.

ROBERT H. PETERSON CO.,

Defendant-Appellant.

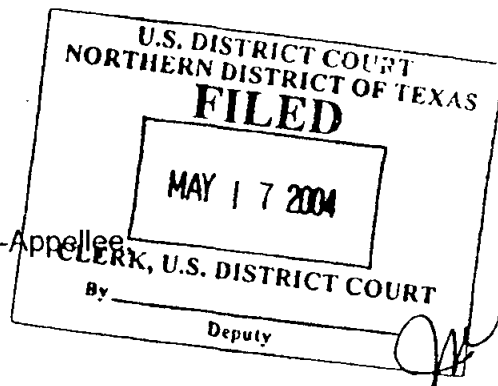

William D. Harris, Jr., Schulz & Associates, of Dallas, Texas, argued for plaintiff-appellee. With him on the brief were Charles W. Gaines and Greg H. Parker, Hitt Gaines P.C., of Richardson, Texas.

Leland W. Hutchinson, Jr., Freeborn & Peters, of Chicago, Illinois, argued for defendant-appellant. With him on the brief were Jennifer L. Fitzgerald and David S. Becker.

Appealed from: United States District Court for the Northern District of Texas

Judge Jerry Buchmeyer

United States Court of Appeals for the Federal Circuit

03-1298

GOLDEN BLOUNT, INC.,

Plaintiff-Appellee,

v.

ROBERT H. PETERSON CO.,

Defendant-Appellant.

DECIDED: April 19, 2004

Before MAYER, Chief Judge, NEWMAN, and LINN, Circuit Judges.

Opinion for the court filed by Circuit Judge LINN. Opinion concurring in part and dissenting in part filed by Circuit Judge NEWMAN.

Robert H. Peterson Co. ("Peterson") appeals from the final judgment of the United States District Court for the Northern District of Texas, which concluded that: (1) Peterson infringed certain claims of U.S. Patent No. 5,988,159 ("the '159 patent"), owned by Golden Blount, Inc. ("Blount"); (2) Peterson's infringement was willful; (3) prosecution history estoppel did not preclude the application of the doctrine of equivalents; (4) the '159 patent was not invalid; and (5) the case was exceptional, warranting the award of attorneys' fees. Golden Blount, Inc. v. Robert H. Peterson Co., No. 3-01-CV-0127-R (Aug. 9, 2002) ("Final Judgment"); Golden Blount, Inc. v. Robert H. Peterson Co., No. 3-01-CV-0127-R (Aug. 9, 2002) ("Findings of Fact & Conclusions of Law"). The district court also determined that Blount was entitled to lost profit

damages. Findings of Fact & Conclusions of Law at 8, para. 9. Because the district court did not provide findings of fact to support a conclusion of infringement, as required by Rule 52(a) of the Federal Rules of Civil Procedure, the judgment is vacated-in-part and remanded. However, because Peterson has not shown invalidity by clear and convincing evidence, we affirm that portion of the judgment. Finally, we find no evidence of Peterson raising the issue of inequitable conduct before the district court, and therefore conclude that that argument has been waived.

BACKGROUND

The patent-in-suit relates to fireplace burners and associated equipment. In particular, the '159 patent discloses a gas-fired, artificial logs and coals-burner assembly arranged to "enhanc[e] the natural burn in cooperation of the fireplace draft as well as the aesthetic beauty of the imitation burning logs, coals, and embers." '159 patent, Abstract. The assembly is described as follows:

The present burner assembly is the combination of an inexpensive primary gas logs burner in gas flow communication with a secondary coals- and embers-burner tube positioned forward and below the primary burner which operates to enhance the natural draft of the fireplace to improve efficiency of burn and aesthetic appeal of the gas-fired artificial logs, coals- and embers-burner assembly.

Id. at col. 3, ll. 54-60.

Figure 2, below, illustrates a secondary burner apparatus 100 in combination with a primary burner tube 14. A connector 102 attaches the primary burner tube 14 to the secondary burner tube 104, creating an enclosed fluid path for gas. A valve 106 is interposed in this fluid path and enables a user to adjust the amount of gas entering the secondary burner. Id. at col. 5, ll. 26-40. Secondary burner tube 104 includes a plurality of apertures, or gas discharge ports, along its length. The apertures can be

evenly spaced or clustered, and permit gas to be discharged in a direction away from the opening of the fireplace. Directing the gas discharge away from the opening enhances the aesthetic beauty of the fire and improves safety. *Id.* at col. 5, ll. 45-63.

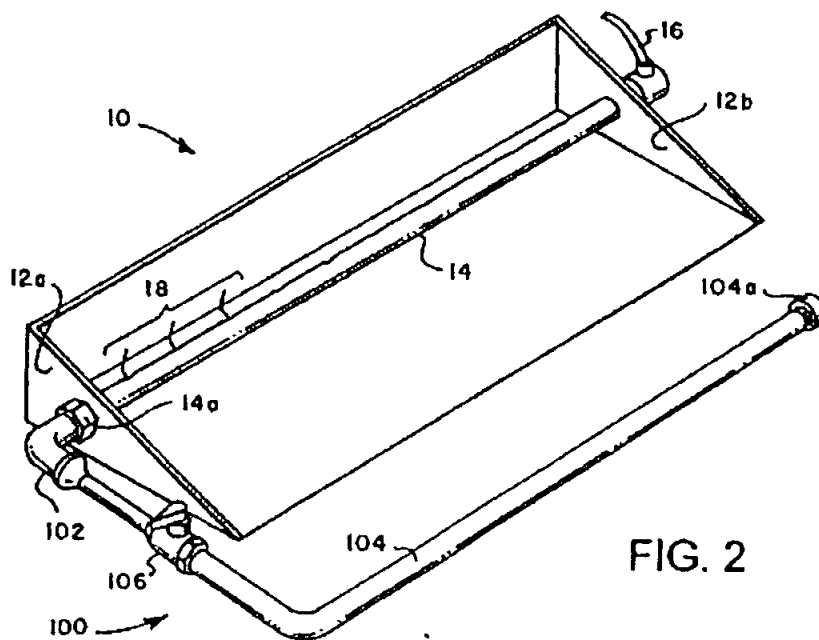

FIG. 2

Independent claims 1 and 17 are at issue in this suit, as well as dependent claims 2, 5, 7-9, 11-13, and 15-16. Independent claim 1 is representative and recites:

1. A gas-fired artificial logs and coals-burner assembly for fireplace comprising:
 - an elongated primary burner tube including a plurality of gas discharge ports;
 - a secondary coals burner elongated tube positioned forwardly of the primary burner tube;
 - a support means for holding the elongated primary burner in a raised level relative to the forwardly position secondary coals burner elongated tube;
 - the secondary coals burner elongated tube including a plurality of gas discharge ports;
 - the elongated primary burner tube and the secondary coals burner elongated tube communicating through tubular connection means wherein the gas flow to the secondary elongated coals burner tube is fed through the primary burner tube and the tubular connection means;

a valve for adjusting gas flow to the secondary coals burner elongated tube positioned in the tubular gas connection means; and the primary burner tube being in communication with a gas source with a gas flow control means therein for controlling gas flow into said primary burner tube.

The '159 patent issued on November 23, 1999. On December 10, 1999, Blount sent a letter to Peterson, informing Peterson of the issuance of the '159 patent and stating that Blount believed Peterson to be "marketing a device that is substantially similar to the burner assembly" claimed in the patent. The letter further stated that Blount would "take whatever steps are reasonable and necessary to prevent infringement of the patent." Peterson acknowledged receipt of the letter on December 30, 1999. On May 3, 2000, Blount again wrote Peterson, stating:

We have inspected your EMB Series Ember Flame Booster and find it to be clearly within the scope of at least some of the claims of the subject patent. Our client views any infringement of its patent with great concern and will take necessary steps to stop any such infringement.

Peterson responded that it disagreed with Blount's assessment that the Peterson devices were substantially similar to the claimed invention and requested that Blount explain, in detail, the basis upon which Blount believed Peterson was infringing. Blount never answered, and on January 18, 2001, Blount filed this suit against Peterson, alleging patent infringement.

A bench trial was held, beginning on July 29, 2002. The district court issued its Final Judgment against Peterson on August 9, 2002, along with supporting Findings of Fact and Conclusions of Law. The district court concluded, among other things, that: (1) Peterson literally infringed each of the asserted claims, Findings of Fact & Conclusions of Law at 3, para. 16; *id.* at 7, para. 7; (2) if Peterson did not literally

infringe, Peterson contributorily infringed or induced infringement, id. at 3-4, paras. 17-18; id. at 7, para. 3; (3) in the alternative, prosecution history estoppel did not apply, and Peterson infringed under the doctrine of equivalents, id. at 4, para. 19; id. at 7, para. 5; (4) Peterson's infringement was willful, id. at 5, para. 26; id. at 8, para. 10; (5) the claims of the patent are "valid," id. at 7, para. 7; (6) Blount had established the Panduit factors and was entitled to lost profit damages, id. at 8, para. 9; and (7) the case is exceptional under 35 U.S.C. § 285, supporting an award of attorney fees, id. at 8, para. 11. Peterson filed a timely appeal, asserting that each of the district court's conclusions was incorrect.

This court has jurisdiction over the appeal under 28 U.S.C. § 1295(a)(1).

ANALYSIS

A. Standard of Review

On appeal from a bench trial, this court reviews the district court's conclusions of law de novo and findings of fact for clear error. Brown & Williamson Tobacco Corp. v. Philip Morris Inc., 229 F.3d 1120, 1123 (Fed. Cir. 2000). Claim construction is a question of law, reviewed de novo. Cybor Corp. v. FAS Techs., Inc., 138 F.3d 1448, 1454 (Fed. Cir. 1998) (en banc). A determination of infringement, whether literal or under the doctrine of equivalents, is a question of fact and is reviewed under the clearly erroneous standard. Biovail Corp. Int'l v. Andrx Pharms., Inc., 239 F.3d 1297, 1300 (Fed. Cir. 2001). Invalidity based on obviousness is a question of law, reviewed de novo, based on underlying factual findings, reviewed for clear error. Graham v. John Deere Co., 383 U.S. 1, 17 (1966). To establish invalidity, the supporting facts must be

shown by clear and convincing evidence. WMS Gaming Inc. v. Int'l Game Techs., 184 F.3d 1339, 1355 (Fed. Cir. 1999).

B. Infringement

Peterson argues first that the district court erred in finding literal infringement of each of the asserted claims because the district court's claim constructions are erroneous and the conclusion of literal infringement is not supported by any evidence. Peterson also argues that the district court's findings of contributory infringement and induced infringement are erroneous because the district court applied the incorrect standards and because there is no supporting evidence for the findings. Peterson further argues that the district court's conclusion, in the alternative, of infringement under the doctrine of equivalents is flawed because the district court's application reads out a claim limitation. Peterson also argues that prosecution history estoppel precludes a finding of infringement under the doctrine of equivalents. Blount, on the other hand, argues that the district court's claim constructions were proper, that the district court applied the correct standards, that the district court's infringement findings were supported by substantial evidence, and that prosecution history estoppel does not apply.

A determination of infringement requires a two-step analysis. The court must determine (1) "the scope and meaning of the patent claims asserted," and (2) how "the properly construed claims . . . compare[] to the allegedly infringing device." Cybor Corp., 138 F.3d at 1454. Turning first to claim construction, there are two claim terms in dispute on appeal—"raised level" and "away from the fireplace opening."

Claim 1 recites that a support means holds “the elongated primary burner in a raised level relative to the forwardly position secondary coals burner elongated tube.” The district court concluded that “raised level” meant that the primary burner was at a raised level with respect to the secondary burner, for example with respect to the centerline. Findings of Fact & Conclusions of Law at 6, para. 2. Peterson argues that the so-called “centerline” test is incorrect and that the raised level should be measured with respect to the level of the gas ports. Blount argues that the centerline test is correct, or alternatively, that any test that uses a plausible reference point, such as the top of the tube, can be used.

The plain language of the claim is relatively straightforward, and the district court correctly gave the claim term its ordinary and customary meaning. The only dispute comes from the reference point used to determine if the primary burner tube is at a raised level. Typically, when measuring whether something is higher than, or at a raised level with respect to, another object, the tops of the two items at issue are compared. There is nothing to indicate that persons skilled in the art would attribute any other or different meaning. Thus, the ordinary meaning of “raised level” in claim 1 refers to the top of the primary burner tube being at a raised level with respect to the top of the secondary burner tube. The written description and prosecution history provide no limitation or illumination on this issue. The written description merely indicates that the purpose of the positioning “enhances the natural draft of the fireplace to improve efficiency of burn and aesthetic appeal.” ’159 patent, col. 3, ll. 54-60. This purpose, however, does not indicate which portion of the burner tubes should be utilized as a reference. We thus construe the limitation “at a raised level” in claim 1 to

refer to the tops of the two burner tubes. Claim 17 recites that the secondary burner tube is positioned below the primary burner tube. Although the district court did not separately construe the term “below,” both parties argued that the vertical limitations in claims 1 and 17 should be construed similarly. We agree, and conclude that the tops of the tubes should be used to determine whether the secondary burner tube is positioned below the primary burner tube as recited in claim 17.

Claim 17 further recites that the gas ports are directed “away from the fireplace opening.” The district court construed this term to mean “any direction that does not include a horizontal component pointed toward the vertical plane of the fireplace opening.” Findings of Fact & Conclusions of Law at 7, para. 2. Peterson argues that, regardless of the ordinary meaning of the claim language, the specification requires the gas ports to be directed towards the primary burner. Blount, on the other hand, argues that Peterson’s contention is wrong and is based solely on a single embodiment. The district court’s construction reflects the ordinary meaning of the claim language. Nothing in the specification suggests that the applicant disavowed or otherwise disclaimed any scope of coverage. In particular, the specification states that “[i]n the secondary burner tube 104, the gas is discharged in a direction away from the opening of the fireplace, or in another aspect, is directed somewhat toward or directly toward the primary burner 14.” ’159 patent, col. 5, ll. 58-62. That language supports Blount’s argument that the reference in the written description to the direction of the gas ports towards the primary burner relates only to an embodiment. Peterson points to no portions of the specification that limit the ordinary meaning of the claim language. Thus, we agree with the district court that “away from the fireplace opening” means “any

direction that does not include a horizontal component pointed toward the vertical plane of the fireplace opening.”

With respect to the second step of the infringement analysis, the district court did not provide any findings of fact or analysis to support its conclusion. Rather, the district court simply stated conclusions without any apparent bases. In the district court’s Findings of Fact and Conclusions of Law, its entire infringement analysis for literal infringement, contributory infringement, induced infringement, and infringement under the doctrine of equivalents is presented in six short and conclusory paragraphs. For example, with respect to literal infringement, the only discussion in the entire district court opinion is as follows: “Applying the claim construction referred to in the Conclusions of Law, this Court finds there is [literal infringement of the asserted claims].” Findings of Fact & Conclusions of Law at 3, para. 16. There is nothing to explain how the limitations of the claims, as construed, compare to the allegedly infringing device. See, e.g., Cybor Corp., 138 F.3d at 1454 (explaining that “the properly construed claims . . . [are] compared to the allegedly infringing device”). The paragraphs relating to contributory infringement, induced infringement, and infringement under the doctrine of equivalents are equally conclusory and devoid of any analysis. In the absence of any findings, this court cannot determine whether the trial court had any evidence to support its conclusions, nor is this court able to determine whether the district court applied appropriate legal standards.

After a bench trial, a trial court must put forth the findings of fact relied upon to justify its actions. Fed. R. Civ. P. 52(a); Atl. Thermoplastics Co. v. Faytex Corp., 5 F.3d 1477, 1478-79 (Fed. Cir. 1993). While Rule 52(a) “does not require elaborate,

detailed findings on every factual issue raised," the district court opinion "must include as many of the subsidiary facts as are necessary to disclose . . . the steps by which the trial court determined factual issues and reached its ultimate conclusions." Atl. Thermoplastics, 5 F.3d at 1479.

When the trial court provides only conclusory findings, illuminated by no subsidiary findings or reasoning on all the relevant facts, as was the case here, there is not that 'detail and exactness' on the material issues of fact necessary for an understanding by an appellate court of the factual basis for the trial court's findings and conclusions, and for a rational determination of whether the findings of the trial court are clearly erroneous.

Id. (quoting EEOC v. United Va. Bank/Seaboard Nat'l, 555 F.2d 403, 406 (4th Cir. 1977)). In such situations, remand is necessary and proper. Id.

Because the district court's sparse opinion provides this court with only bald conclusions for review, we conclude that the district court's judgment as to literal infringement, contributory infringement, induced infringement, and infringement under the doctrine of equivalents is insufficient under Rule 52(a). We thus vacate those portions of the district court's opinion and remand those issues to the district court for specific factual findings. Further, because we have vacated the district court's judgment with respect to all aspects of infringement, we also vacate and remand the district court's judgment as to willfulness, the exceptional nature of the case, and damages.

On remand, the district court "shall find the facts specially and state separately its conclusions of law thereon." Fed. R. Civ. P. 52(a). Further, on remand, if the district court finds no direct infringement by Peterson, but concludes that the '159 patent is infringed, either literally or under the doctrine of equivalents, by a customer of Peterson

or other party using Peterson components, the district court must then consider the claims of contributory and induced infringement to find Peterson in violation of the patent. See Carborundum Co. v. Molten Metal Equip. Innovations, Inc., 72 F.3d 872, 876 n.4 (Fed. Cir. 1995) (“Absent direct infringement of the claims of a patent, there can be neither contributory infringement or inducement of infringement.”). Contributory infringement liability arises when one “sells within the United States . . . a component of a patented machine . . . knowing the same to be especially made or especially adapted for use in an infringement of such patent, and not a staple article or commodity of commerce suitable for substantial noninfringing use.” 35 U.S.C. § 271(c) (2000). Thus, Blount must show that Peterson “knew that the combination for which its components were especially made was both patented and infringing.” Preemption Devices, Inc. v. Minn. Mining & Mfg., Co., 803 F.2d 1170, 1174 (Fed. Cir. 1986). Further, Blount must show that Peterson’s components have no substantial noninfringing uses. Alloc, Inc. v. ITC, 342 F.3d 1361, 1374 (Fed. Cir. 2003). In order to find Peterson liable for inducing infringement under 35 U.S.C. § 271(b), Blount must show that Peterson took actions that actually induced infringement. Met-Coil Sys. Corp. v. Korner Unlimited, Inc., 803 F.2d 684, 687 (Fed. Cir. 1986) (“There can be no inducement of infringement without direct infringement by some party.”). Further, Blount must show that Peterson knew or should have known that such actions would induce direct infringement. Micro Chem. Inc. v. Great Plains Chem. Co., 194 F.3d 1250 (Fed. Cir. 1999).

C. Invalidity

Peterson also argues that the district court erred in not concluding that the '159 patent would have been obvious in light of prior art related to an earlier assembly of Peterson, known as the F3 device, and drawings by a Mr. Jankowski. Before this court, Peterson offers merely the bare assertion that the patent claims would have been obvious. We therefore have no reason to overturn the district court's conclusion that the '159 patent is not invalid, Findings of Fact & Conclusions of Law at 7, para. 7, based on its findings that "[t]he prior art relied on by [Peterson] does not show the same concepts" as the '159 patent claims, *id.* at 2, para. 7, and that the drawings failed to meet the "clear and convincing evidence" standard, *id.* at 2, para. 9. Therefore, we affirm the portion of the district court's opinion holding the '159 patent not invalid.

D. Inequitable Conduct

Peterson finally argues that the district court erred in not holding the '159 patent unenforceable for inequitable conduct. Blount counters that Peterson has waived this argument, because Peterson did not raise it in its district court pleadings. Because there is no evidence that Peterson raised the issue of inequitable conduct before the district court, and because Peterson has not suggested, nor do we find, any special circumstances in this case to militate against a finding of waiver, Peterson cannot now be heard to make the argument for the first time on appeal. See Sage Prods., Inc. v. Devon Indus., Inc., 126 F.3d 1420, 1426 (Fed. Cir. 1997) (stating that, barring a few exceptions, the failure to raise an argument at the trial level constitutes a waiver of that argument on appeal).

CONCLUSION

For the foregoing reasons, the court: (1) vacates the district court's judgment with respect to literal infringement, contributory infringement, induced infringement, and infringement under the doctrine of equivalents; (2) vacates the district court's judgment with respect to willfulness, the exceptional nature of the case, and all damages awarded; (3) affirms the district court's judgment finding the '159 patent not invalid; and (4) concludes that Peterson has waived its inequitable conduct argument.

AFFIRMED-IN-PART, VACATED-IN-PART, AND REMANDED

COSTS

No costs.

United States Court of Appeals for the Federal Circuit

03-1298

GOLDEN BLOUNT, INC.,

Plaintiff-Appellee,

v.

ROBERT H. PETERSON CO.,

Defendant-Appellant.

NEWMAN, Circuit Judge, concurring in part, dissenting in part.

I concur in the court's judgment as to validity and inequitable conduct, but I must, respectfully, dissent as to the decision to remand for further findings and conclusions as to infringement and its consequences. The issues are before us on appeal, and require our decision, not a remand for a longer opinion.

The district court, after a three-day trial, issued "findings of fact and conclusions of law" in the form, Peterson alleges, provided by the plaintiff Golden Blount, in whose favor the court decided. Peterson appealed, and in the section of its brief challenging the district court's findings of infringement it focused primarily on the court's claim construction, arguing for a construction under which it alleges it would not infringe.

In its briefs, Peterson does not argue that the district court failed to provide an adequate analysis of infringement, as the panel majority now holds. Nor is there any indication that Peterson raised such an objection before the district court. Of Peterson's two post-trial motions to amend, of which the court granted one and denied the other, neither asked for greater detail in the findings or conclusions of the district court. In its brief as appellant, Peterson discusses relevant testimony, and refers to Blount's "Claim Interpretation Chart," on which the district court's finding of infringement was based. Peterson asks us to reach a different conclusion from that reached by the district court as to infringement. My colleagues on this panel do not do so -- they instead remand to the district court to make more explicit findings.

The fireplace components at issue here are relatively simple mechanical devices and the disputed claim limitations are straightforward -- whether one burner tube is at a "raised level" with respect to another and whether gas ports are directed "away from the fireplace opening." Each side advocated a claim construction under which it would win the infringement dispute. As is so often the case in trials involving "Markman hearings," the question of infringement was essentially decided as a matter of claim construction. The claim construction is a matter of law, and is given de novo determination; this is the premise on which the parties argue the appeal.

As the appellant, Peterson bears the burden of convincing us that the district court committed reversible error. Peterson did not challenge the specificity of the district court's infringement analysis, and did not appeal this aspect. If Peterson can establish that the findings and conclusions are not supported by law or evidence, then reversal is required -- not remand for more findings.

The case should be decided, not sua sponte remanded for a longer opinion.
Thus I must, respectfully, dissent from the remand decision of my colleagues.

CERTIFIED COPY
I HEREBY CERTIFY THIS DOCUMENT
IS A TRUE AND CORRECT COPY
OF THE ORIGINAL ON FILE.

UNITED STATES COURT OF APPEALS
FOR THE FEDERAL CIRCUIT

By: *Sharon Mims* Date: 5-10-04

IN THE UNITED STATES DISTRICT COURT
FOR THE NORTHERN DISTRICT OF TEXAS
DALLAS DIVISION

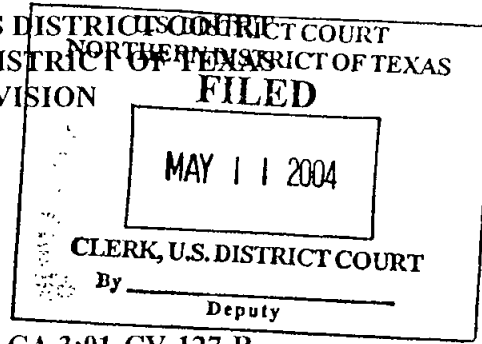

GORDON BLOUNT, INC.,

Plaintiff,

v.

ROBERT H. PETERSON CO.,

Defendant.

§
§
§
§
§
§
§
§
§
§

CA 3:01-CV-127-R

It is ORDERED that the parties shall submit proposed findings of fact and conclusions of law on the issues of literal infringement, contributory infringement, induced infringement, infringement under the doctrine of equivalents, willfulness, the exceptional nature of the case, and damages. Each party shall file its proposed findings and conclusions by June 10, 2004.

IT IS SO ORDERED.

ENTERED: May 11, 2004.

JERRY BUCHMEYER
SENIOR UNITED STATES DISTRICT JUDGE
NORTHERN DISTRICT OF TEXAS



IN THE UNITED STATES DISTRICT COURT
NORTHERN DISTRICT OF TEXAS
DALLAS DIVISION

U.S. DISTRICT COURT
NORTHERN DISTRICT OF TEXAS
FILED
JUN 10 2004
CLERK, U.S. DISTRICT COURT
By _____ Deputy

GOLDEN BLOUNT, INC.

Plaintiff,

v.

ROBERT H. PETERSON CO.

Defendant.

§
§
§
§
§
§
§
§
§
§

Civil Action No. 3-01CV0127-R

(JURY TRIAL DEMANDED)

DEFENDANT'S PROPOSED FINDINGS OF FACT AND CONCLUSIONS OF LAW

Now comes defendant Robert H. Peterson Co. ("Peterson"), by its undersigned counsel, and pursuant to order of court, proposes the following Findings of Fact and Conclusions of Law to be entered pursuant to Rule 52, F.R.Civ.P.:

FINDINGS OF FACT¹

PARTIES.

1. Plaintiff, Golden Blount, Inc., is the owner of U.S. Patent 5,988,159 (the "159 Patent") entitled "Gas-Fired Artificial Logs and Coals-Burner Assembly." (PX 1.)
2. The patent issued on November 23, 1999. (PX 1.)
3. Defendant has manufactured and sold gas log sets, burners, grates and ceramic logs since the 1940's.

¹ Citations to trial exhibits shall be referred to herein as "PX" and "DX." Citations to the trial transcript shall be indicated as "Tr." with the volume number preceding the "Tr." and the page number following it.

PETERSON'S "G4" PRODUCT.

4. Peterson's largest selling product is the model "G4," which is also known as the "Glowing Ember Burner." (2 Tr. 69-70; DX 32.)
5. The "G4" product consists of a burner pan and a single burner tube. (1 Tr. 72; DX 32.)
6. The "G4" is sold by Peterson without artificial logs. (2 Tr. 178.)
7. The "G4" product, as made, used and sold by Peterson, comprises a "primary burner tube" without a "secondary burner tube," to use the terminology of the '159 Patent. (Substitute Stmt. of Stipulated Facts at ¶6; R.H. Peterson 30(b)(6) Deposition of Leslie Bortz² ("Bortz 30(b)(6) Dep.") 22, 27; DX 32.)

PETERSON'S "EMB" PRODUCT.

8. Peterson's accused product is known as the "EMB" or "ember flame booster," an accessory that can be assembled or retrofitted to a "G4" primary burner to produce a front flame and ember icing. (2 Tr. 117; PX 6; DX 31.)
9. The "EMB" product, as made, used and sold by Peterson, comprises solely a "secondary burner tube" without a "primary burner tube," to use the terminology of the '159 Patent. (2 Tr. 86-7, 117, 178; DX 34.)
10. Peterson packages and sells the "EMB" product to distributors separately from the "G4" product. (2 Tr. 86-7, 178; DX 31; DX32.)
11. The "EMB" and "G4" are not sold together by Peterson. (2 Tr. 69-70, 73.)
12. The "EMB" and "G4" are never assembled by Peterson. (2 Tr. 73.)

² The R.H. Peterson 30(b)(6) Deposition of Leslie Bortz was introduced at trial. (2 Tr. 39.)

13. The assembly of Peterson's "G4" and "EMB" products is done in the field by the customer or an installer hired by the customer. (2 Tr. 71, 73-4.)

14. During assembly, the "EMB" secondary burner product is attached to the "G4" primary burner by means of a ½" female pipe fitting. (PX 7, p.3).

15. The installed level of the top of the "EMB" secondary burner relative to the top of the "G4" primary burner will depend upon the position of the "EMB" when its female pipe fitting is tightened. (PX 7, p.3).

16. It is possible for the customer to install the "EMB" secondary burner tube such that its top is level with or above the top of the "G4" primary burner tube by tightening the "EMB's" female screw fitting when the top of the "EMB" happens to be level with or above the top of the "G4." (PX 7, p. 3).

17. When he was asked whether one could "completely change the level [of the secondary burner] if you wanted to" in Plaintiff's Exhibits 3A (demonstrative of plaintiff's product) and 4A, Mr. Golden Blount testified, "That's correct." (1 Tr. 144.)

PETERSON'S "G5" PRODUCT.

18. Peterson also sells a product known as the "G5" which consists of a primary burner tube and burner pan together with all of the gas connections, valves and grates pre-assembled at the Peterson factory in order to obtain the certification of the Canadian Gas Association (successor to the American Gas Association). (1 Tr. 74; 2 Tr. 179, 196.)

19. Mr. Bortz testified that the Peterson "G4" and "G5" products were different in that the "G5" included substantial equipment necessary for Canadian Gas Association certification. (Bortz 30(b)(6) Dep. 22-24.)

20. Mr. Bortz testified that Peterson's "G5" product sells at retail for approximately twice what the "G4" product sells for. (Bortz 30(B)(6) Dep. 25.)

21. No other witness testified that the "G4" and "G5" products are the same or are manufactured to the same standards or by the same methods.

22. As usually made, used and sold by Peterson, the "G5" does not include the "EMB" accessory or any other secondary burner tube of the type claimed in the '159 Patent. (Substitute Stmt. of Stipulated Facts at ¶6; 2 Tr. 72-3, 179.)

23. Although a customer may specially order a "G5" product with an "EMB" accessory, Peterson has sold "very few" of these combinations. (2 Tr.179.)

24. The "G5" is "very seldom" sold with a pre-assembled "EMB." (2 Tr. 72-3.)

25. During the relevant time period, Peterson sold a total of approximately 10 "G5" products. (1 Tr. 74.)

26. No substantial evidence shows that, on any of the very few occasions when Peterson did assemble and sell a "G5" together with an "EMB," that the top of the "G5" primary burner tube was installed at a "raised level" with respect to the top of the "EMB" secondary burner tube.

27. No substantial evidence shows that, on any of the very few occasions when Peterson did assemble and sell a "G5" with together an "EMB," that the top of the "EMB" secondary burner tube was installed "below" the top of the "G5" primary burner tube.

28. On any of the very few occasions when Peterson did assemble and sell a "G5" with an "EMB," no substantial evidence shows how Peterson assembled these products.

NO EVIDENCE OF INFRINGEMENT.

29. As made, used and sold by Peterson, the "EMB" accessory product is comprised solely of a secondary burner and does not comprise the dual burner system claimed in the '159 Patent.

30. As made, used and sold by Peterson, the "G4" product is comprised solely of a primary burner and burner pan and does not comprise the dual burner system claimed in the '159 Patent.

31. As usually made, used and sold by Peterson, the "G5" product is comprised solely of a primary burner and related connections and does not comprise the dual burner system claimed in the '159 Patent.

32. Plaintiff offered no substantial evidence proving even one infringing assembly or installation of an "EMB" with a primary burner product, either by Peterson or by anyone else.

33. The record contains no substantial evidence showing how Peterson ever assembled or installed any "EMB" accessory product with any primary burner.

34. Without being the assembler of the "EMB" with a primary burner, Peterson cannot be a direct infringer of the '159 Patent.

35. The record contains no substantial evidence about how any Peterson dealer or customer ever assembled or installed any "EMB" accessory product.

36. The record contains no substantial evidence that any Peterson dealer or customer or anyone else ever assembled or installed any "EMB" accessory product with a primary burner in a manner which infringed any claim of the '159 Patent.

– PLAINTIFF’S DEMONSTRATIVE EXHIBITS.

37. Prior to trial, defendant raised authenticity and other objections to each of plaintiff’s demonstrative exhibits. (Robert H. Peterson Co.’s Objections to Plaintiff’s Pre-Trial Disclosures at 3.)

38. At trial, plaintiff played a narrated video tape. (1 Tr. 32-3; PX 8.)

39. Mr. Golden Blount, the witness who was testifying while the video tape was played, identified the voice of the narrator as Bill Romas, an employee of plaintiff. (1 Tr. 34.)

40. Because Mr. Romas was never called as a witness, none of the statements which he made on the videotape were ever subject to cross examination by Peterson.

41. Mr. Blount testified that the early portions of the video tape showed an authentic picture of plaintiff’s dual burner product in operation. (1 Tr. 43.)

42. At one point, Mr. Blount identified a picture on the video tape as showing a “Peterson set” with the “burner off.” (1 Tr. 135-45.)

43. Mr. Blount did not testify which Peterson product or products comprised what he called the “Peterson set” that he saw on the video tape. (1 Tr. 135-45.)

44. Mr. Blount did not testify that the “Peterson set” which he identified on the video tape included an “EMB” secondary burner accessory. (1 Tr. 135-45.)

45. Mr. Blount did not testify that the “Peterson set” which he identified on the video tape did not include a Peterson “Front Flame Director.” (1 Tr. 135-45.)

46. Mr. Blount never identified the Peterson products, if any, which were part of the picture which he described as the “Peterson set” on the video tape. (1 Tr. 26-149; 3 Tr. 35-42.)

47. No witness ever testified that any picture shown on the video tape was an authentic or accurate depiction of any product or combination of products made, used or sold by Peterson. (1 Tr. 133-45.)

48. No witness ever testified that any picture shown on the video tape was an authentic or accurate depiction of any product or combination of any products made, used or sold by Peterson which had been assembled with the top of a primary burner tube at a "raised level" with respect to the top of a secondary burner tube or with the top of a secondary burner tube installed "below" the top of a primary burner tube. (1 Tr. 133-45.)

49. No substantial evidence shows that Peterson made, used or sold the apparatus identified by Mr. Blount as the "Peterson set" in the assembled configuration shown in the video tape.

50. No witness testified how the apparatus which Mr. Blount identified as the "Peterson set" shown in the video tape had been assembled or who had assembled it.

51. The video tape does not show any infringement of the '159 Patent by any Peterson product or combination of Peterson products. (1 Tr. 133-45.)

52. At trial, plaintiff produced a demonstrative exhibit consisting of physical primary and secondary burner tubes assembled together. (1 Tr. 41; PX 4A.)

53. Plaintiff's counsel originally referred to Plaintiff's Exhibit 4A during his opening statement without foundation, assuring the court that "we'll connect up later." (1 Tr. 6, 38.)

54. Later, one of plaintiff's attorneys, Mr. Greg Parker, represented to the Court that Plaintiff's Exhibits "4A and 4B is Defendant Peterson's device." (1 Tr. 42.)

55. Plaintiff, however, never offered any foundation through any witness testimony to identify or authenticate Plaintiff's Exhibit 4A.

56. No witness ever affirmatively identified or authenticated Plaintiff's Exhibit 4A as consisting of a Peterson product or a combination of Peterson products.

57. No substantial evidence shows that the burner tubes from which Plaintiff's Exhibit 4A had been assembled had been made, used or sold by Peterson.

58. No substantial evidence shows that the burner tubes comprising Plaintiff's Exhibit 4A had been assembled by Peterson or by any Peterson dealer or customer in the configuration in which the apparatus appeared in court.

59. No substantial evidence establishes a chain of custody linking Plaintiff's Exhibit 4A to Peterson in any way.

60. Plaintiff's Exhibit 4A does not show any infringement of the '159 Patent by Peterson.

61. Plaintiff's Exhibit 4A does not show any infringement of the '159 Patent by any Peterson dealer or customer.

62. Plaintiff produced a photograph entitled "Defendant's Log Set with Ember Flame Booster." (PX 5A.)

63. Mr. Blount testified that Plaintiff's Exhibit 5A "is a Peterson log set with their ember flame burner." (1 Tr. 43.)

64. No testimony was offered to establish that Mr. Blount had personal knowledge that Plaintiff's Exhibit 5A depicted any Peterson product or combination of Peterson products. (1 Tr. 43.)

65. No other witness attempted to authenticate Plaintiff's Exhibit 5A.

66. No testimony was offered to establish who took the photograph which is Plaintiff's Exhibit 5A. (1 Tr. 43.)

67. Mr. Blount did not testify to facts showing that he had personal knowledge of how the photograph which is Plaintiff's Exhibit 5A had been taken. (1 Tr. 43; (1 Tr. 26-149; *see also* 3 Tr. 35-42.)

68. Neither Mr. Blount nor any other witness testified that Plaintiff's Exhibit 5A accurately depicts any product in the form made, used or sold by Peterson. (1 Tr. 43.)

69. Neither Mr. Blount nor any other witness testified that Peterson assembled the apparatus in the form depicted in Plaintiff's Exhibit 5A. (1 Tr. 43.)

70. Neither Mr. Blount nor any other witness testified that Plaintiff's Exhibit 5A accurately depicts any assembly of Peterson component products by any Peterson dealer or customer or by anyone else. (1 Tr. 43.)

71. Neither Mr. Blount nor any other witness testified that any Peterson dealer or customer assembled the apparatus in the form depicted in Plaintiff's Exhibit 5A. (1 Tr. 43.)

72. Neither Mr. Blount nor any witness testified that the apparatus depicted in Plaintiff's Exhibit 5A includes a primary burner installed at a "raised level" with respect to the top of a Peterson "EMB" secondary burner product. (1 Tr. 43.)

73. Neither Mr. Blount nor any witness testified that the apparatus depicted in Plaintiff's Exhibit 5A includes a Peterson "EMB" secondary burner product installed "below" the top of a primary burner. (1 Tr. 43.)

74. Because neither the "ember flame booster" secondary burner nor the primary burner are visible in Plaintiff's Exhibit 5A, it is not evident from the photograph whether the top of the secondary burner tube is installed above, level with or below the top of the primary burner tube. (PX 5A.)

75. Neither Mr. Blount nor any other witness testified that the apparatus as depicted in Plaintiff's Exhibit 5A infringes the '159 Patent. (1 Tr. 43.)

76. Plaintiff also produced a "Literal Infringement Chart" purporting to illustrate both "Plaintiff's Claimed Device" and "Defendant's Sold Device." (PX 9).

77. Plaintiff used this "Literal Infringement Chart" with Mr. Blount. (1 Tr. 45.)

78. Neither Mr. Blount nor any other witness authenticated Plaintiff's Exhibit 9 as accurately depicting any product made, used or sold by Peterson. (1 Tr. 45-59.)

79. Neither Mr. Blount nor any other witness authenticated Plaintiff's Exhibit 9 as accurately depicting a combination of Peterson products assembled by any Peterson dealer, customer or by anyone else. (1 Tr. 45-59.)

80. No testimony was offered to establish who prepared Plaintiff's Exhibit 9.

81. Plaintiff's Exhibit 9 does not show any infringement of the '159 Patent by Peterson, by any Peterson dealer or customer or by any Peterson product or combination of Peterson products.

82. Plaintiff also produced an "Equivalence Chart" purporting to depict "Defendant's Sold Device." (PX 21.)

83. After identifying Plaintiff's Exhibit 21 during Mr. Blount's testimony, plaintiff's counsel told Mr. Blount, "I see no reason to burden you with it" and asked no questions of Mr. Blount about the exhibit. (1 Tr. 60.)

84. No other witness ever testified about Plaintiff's Exhibit 21.

85. Neither Mr. Blount nor any other witness authenticated Plaintiff's Exhibit 21 as accurately depicting any product made, used or sold by Peterson. (1 Tr. 60.)

86. Neither Mr. Blount nor any other witness authenticated Plaintiff's Exhibit 21 as accurately depicting a combination of Peterson products assembled by any Peterson dealer, customer or by anyone else. (1 Tr. 60.)

87. No testimony was offered to establish who prepared Plaintiff's Exhibit 21.

88. Plaintiff's Exhibit 21 does not show any infringement of the '159 Patent by Peterson, by any Peterson dealer or customer or by any Peterson product or combination of Peterson products.

89. Plaintiff produced a drawing purporting to illustrate the alignment of primary and secondary burner tubes from a side view. (PX 22.)

90. No witness ever testified about Plaintiff's Exhibit 22.

91. No witness authenticated Plaintiff's Exhibit 22 as accurately depicting any product made, used or sold by Peterson.

92. No witness authenticated Plaintiff's Exhibit 22 as accurately depicting any combination of Peterson products assembled by any Peterson dealer or customer or by anyone else.

93. No witness authenticated Plaintiff's Exhibit 22 as accurately depicting any matter relevant to this case.

94. No testimony was offered to establish who prepared Plaintiff's Exhibit 22.

95. Plaintiff's Exhibit 22 does not show any infringement of the '159 Patent by Peterson, by any Peterson dealer or customer or by any Peterson product or combination of Peterson products.

-- PLAINTIFF'S WITNESSES.

96. When asked whether he had any personal knowledge about how Peterson sells its products, Mr. Blount testified that:

Well, they sell them through their sales companies and their – to their dealers. Beyond that I can't tell you very much about their operation.

(1 Tr. 138.)

97. Mr. Blount testified that he knows that Peterson sells the "G4" and "EMB" products separately. (1 Tr. 137.)

98. Mr. Blount testified that he was "not really" familiar with Peterson's "G4" product. (1 Tr. 121.)

99. Mr. Blount lacks sufficient personal knowledge of how Peterson manufactures or sells its various products to be able to competently authenticate any of plaintiff's demonstrative exhibits as accurately depicting products made, used or sold by Peterson.

100. Mr. Blount testified that he had personally inspected "zero" installations of Peterson "EMB's" in the field. (1 Tr. 129.)

101. Asked about installations of Peterson "EMB" products, Mr. Blount testified that "I have not seen the installation, no." (1 Tr. 129.)

102. Mr. Blount lacks sufficient personal knowledge of how Peterson dealers or customers installed the "EMB" with any other Peterson product to be able to offer competent testimony about any such installation.

103. Although Mr. Blount gave detailed testimony comparing the claimed elements of the '159 Patent to "Defendant's Sold Device" as shown on Plaintiff's Exhibit 9 (the "Literal

Infringement Chart”), his testimony assumed that Plaintiff’s Exhibit 9 accurately depicted Peterson’s sold product. (1 Tr. 45-60.)

104. Mr. Blount testified that he never had access to Peterson product literature of any type. (1 Tr. 112-13.)

105. Asked about Peterson’s standard installation instructions for “EMB” products, Mr. Blount testified that “I don’t know what the instructions say.” (1 Tr. 127.)

106. Mr. Blount has no personal knowledge that Peterson or any Peterson dealer or customer or anyone else ever installed an “G4” or “G5” primary burner tube with its top at a “raised level” with respect to the top of an “EMB” secondary burner tube.

107. Mr. Blount has no personal knowledge that Peterson or any Peterson dealer or customer or anyone else ever installed an “EMB” secondary burner tube with its top “below” the top of a “G4” or “G5” primary burner tube.

108. Mr. Blount has no personal knowledge that Peterson or any Peterson dealer or customer or anyone else ever installed an “EMB” secondary burner tube in a manner which infringed the ‘159 Patent.

109. When he was shown Defendant’s Exhibit 30 on direct examination during plaintiff’s rebuttal case, Mr. Blount testified as follows:

Q. Would you consider the primary tube to be raised relative to the secondary tube, given this picture?

A. No.

Q. Sir?

A. The primary tube here is not really raised at all.

(3 Tr. 36-7; DX 30.)

110. Mr. Blount did not testify that Peterson took any actions which encouraged, induced or caused anyone to infringe the '159 Patent. (1 Tr. 26-149; 3 Tr. 35-42.)

111. On direct testimony, plaintiff's second witness, Mr. Charles Hanft, was shown Plaintiff's Exhibit 4A, which plaintiff's counsel represented to him "is the Peterson ember burner." Mr. Hanft responded: "I have never seen that." (1 Tr. 154.)

112. Mr. Hanft did not affirmatively identify Plaintiff's Exhibit 4A as a Peterson product or an assembly of Peterson products. (1 Tr. 154.)

113. Mr. Hanft was not asked and did not testify about Plaintiff's Exhibits 5A, 9, 21 or 22. (1 Tr. 150-066.)

114. Although Mr. Hanft is a dealer of these types of products, he does not sell the Peterson "EMB" product. (1 Tr. 156.)

115. Mr. Hanft testified that he had never seen the Peterson "EMB" product offered for sale. (1 Tr. 154.)

116. Mr. Hanft testified that he never saw Peterson introduce the "EMB" product at any convention. (1 Tr. 155.)

117. Mr. Hanft testified that he never saw Peterson's "EMB" product in any Peterson sales brochure. (1 Tr. 155.)

118. Mr. Hanft's testimony concerned plaintiff's ember burner, not Peterson's "EMB" product. (1 Tr. 164.)

119. Mr. Hanft has no personal knowledge about how Peterson distributors sell Peterson's products. (1 Tr. 164.)

120. Mr. Hanft has no personal knowledge that Peterson or any Peterson dealer or customer or anyone else ever installed a primary burner tube with its top at a "raised level" with respect to the top of an "EMB" secondary burner tube. (1 Tr. 164.)

121. Mr. Hanft has no personal knowledge that Peterson or any Peterson dealer or customer or anyone else ever installed an "EMB" secondary burner tube with its top "below" the top of a primary burner tube. (1 Tr. 164.)

122. Mr. Hanft has no personal knowledge that Peterson or any Peterson dealer or customer or anyone else ever installed an "EMB" secondary burner tube in a manner which infringed the '159 Patent. (1 Tr. 164.)

123. Mr. Hanft did not testify that Peterson took any actions which encouraged, induced or caused anyone to infringe the '159 Patent. (1 Tr. 150-066.)

124. Mr. William McLaughlin, a patent attorney called by plaintiff, testified that the Peterson "EMB" did not literally infringe any claim of the '159 Patent. (1 Tr. 181.)

125. Mr. McLaughlin testified that he prepared the answer to interrogatory No. 1 set forth in Defendant's Exhibit 61. (2 Tr. 6; DX 61.)

126. Mr. McLaughlin testified that the answer to interrogatory No. 1 explains reasons why Peterson's "EMB" product does not infringe the '159 Patent. (2 Tr. 6; DX 61.)

127. The answer to interrogatory number 1 states that Peterson's "EMB" product "does not include a support means for holding an elongated primary burner tube in a raised level relative to a secondary coals burner elongated tube." (DX 61.)

128. The answer to interrogatory No. 1 states that Peterson's "EMB" product "does not include a secondary burner tube positioned below a primary tube." (DX 61.)

129. Mr. McLaughlin testified that Peterson's "EMB" secondary burner can be raised up when installed. (2 Tr. 27.)

130. Mr. McLaughlin was not asked and did not testify about Plaintiff's Exhibits 5A, 9, 21 or 22. (1 Tr. 167 – 2 Tr. 38.)

131. Mr. McLaughlin did not testify that Peterson took any actions which encouraged, induced or caused anyone to infringe the '159 Patent. (1 Tr. 167 – 2 Tr. 38.)

132. Plaintiff's final witness, Mr. Leslie Bortz, testified that Peterson had literature describing the EMB product. (2 Tr. 65.)

133. Mr. Bortz did not testify that Peterson took any actions which encouraged, induced or caused anyone to infringe the '159 Patent. (2 Tr. 39-100.)

134. Mr. Bortz testified that he did not know whether Peterson had an "EMB" secondary burner assembled with a primary burner in its product display room to show the distributors who visited Peterson's facilities, but that Peterson had "one in the lab." (2 Tr. 65.)

135. Mr. Bortz did not testify that the top of the Peterson "EMB" secondary burner tube in the apparatus in Peterson's lab was installed "below" the top of the primary burner tube or that the top of the primary burner tube in the lab apparatus was installed at a "raised level" to the top of the secondary burner tube. (2 Tr. 65-6.)

136. Mr. Bortz did not testify that the Peterson "EMB" secondary burner product in Peterson's lab apparatus was installed in a manner infringing the '159 Patent. (2 Tr. 39-100.)

137. Mr. Bortz testified that he did not have personal knowledge of how the Peterson EMB product is normally assembled or by whom it is normally assembled. (2 Tr. 75.)

138. Mr. Bortz did not testify that Peterson or any Peterson dealer or customer, ever installed an "EMB" with its top "below" the top of the customer's primary burner tube or that the

top of the customer's primary burner tube was installed at a "raised level" with respect to the top of the secondary burner tube. (2 Tr. 75; 2 Tr. 39-100.)

139. Mr. Bortz did not testify that Peterson or any Peterson dealer or customer or anyone else ever installed a Peterson "EMB" product in a manner which infringed the '159 Patent. (2 Tr. 75; 2 Tr. 39-100.)

140. Plaintiff called no other witnesses before resting its case in chief. (2 Tr. 99.)

141. None of plaintiff's witnesses had personal knowledge of any installation by Peterson or any Peterson dealer or customer or anyone else of a Peterson "EMB" product and any primary burner tube in which the top of the primary burner tube was installed at a "raised level" with respect to the top of the secondary burner tube.

142. None of plaintiff's witnesses had personal knowledge of any installation by Peterson or any Peterson dealer or customer of Peterson or anyone else of a Peterson "EMB" product in which the top of the secondary burner tube was installed "below" than the top of the primary burner tube.

143. None of plaintiff's exhibits proved any installation by Peterson or any Peterson dealer or customer or anyone else of a Peterson "EMB" product and any primary burner in which the top of the secondary burner tube was installed "below" the top of the primary burner tube or in which the top of the primary burner tube was installed at a "raised level" with respect to the top of the secondary burner tube.

144. None of plaintiff's witnesses testified to having personal knowledge of any installation by Peterson or any Peterson dealer or customer or anyone else of a Peterson "EMB" product and any primary burner in which the secondary burner tube was installed in a manner which infringed the '159 Patent.

145. None of plaintiff's exhibits proved any installation by Peterson or any Peterson dealer or customer or anyone else of a Peterson "EMB" product and any primary burner in which the secondary burner tube was installed in a manner which infringed the '159 Patent.

— DEFENDANT'S WITNESSES.

146. Mr. Jankowski did not testify that Peterson made, used, sold or assembled Plaintiff's Exhibit 4A in the configuration in which it was shown in court. (2 Tr. 101-162.)

147. Mr. Jankowski did not testify that Peterson ever made, used or sold an assembly of primary and secondary burners such as Plaintiff's Exhibit 4A. (2 Tr. 101-162.)

148. Mr. Jankowski did not testify that Plaintiff's Exhibit 4A was an accurate depiction of any product made, used or sold by Peterson. (2 Tr. 101-162.)

149. Mr. Jankowski did not testify that Plaintiff's Exhibit 4A was an accurate depiction of any combination of Peterson products assembled by Peterson or by any Peterson dealer or customer. (2 Tr. 101-162.)

150. Mr. Jankowski did not testify that Peterson took any actions which encouraged, induced or caused anyone to infringe the '159 Patent. (2 Tr. 101-162.)

151. Mr. Tod Corrin testified that Defendant's Exhibit 30 is a CAD drawing that was created by a Peterson employee at his request. (2 Tr. 173; DX 30.)

152. Defendant's Exhibit 30 shows Peterson "G4" and "EMB" products. (DX 30.)

153. Mr. Corrin did not testify that any Peterson dealer or customer ever actually requested a copy of Defendant's Exhibit 30. (2 Tr. 164-203.)

154. Mr. Corrin did not testify to having personally sent a copy of Defendant's Exhibit 30 to any Peterson dealer or customer or to anyone else. (2 Tr. 164-203.)

155. Mr. Corrin did not testify that he personally observed anyone at Peterson ever sending Defendant's Exhibit 30 to any Peterson dealer or customer or to anyone else. (2 Tr. 164-203.)

156. Mr. Corrin did not testify that Peterson ever assembled an "EMB" and a "G4" in the configuration shown on DX 30. (2 Tr. 164-203.)

157. Mr. Corrin did not testify that any Peterson dealer or customer ever actually assembled the "EMB" and a "G4" products in the configuration shown on DX 30. (2 Tr. 164-203.)

158. Mr. Corrin did not testify about how Peterson assembled the "EMB" product with the "G5" product. (2 Tr. 179; 2 Tr. 164-203.)

159. Mr. Corrin did not testify that when Peterson installed an "EMB" product with a "G5" product, it installed the "EMB" secondary burner tube with its top "below" the top of the "G5" primary burner tube or such that the top of the "G5" primary burner tube was at a "raised level" with respect to the top of the "EMB" secondary burner tube. (2 Tr. 179; 2 Tr. 164-203.)

160. Mr. Corrin did not testify that when Peterson installed an "EMB" product with a "G5" product, it installed the "EMB" secondary burner tube in a manner which infringed the '159 Patent. (2 Tr. 179; 2 Tr. 164-203.)

161. With regard to installation of the Peterson "EMB" product, Mr. Corrin testified that "either the consumer would hire an installer or sometimes the dealers provide the service from someone from their store." (2 Tr. 189-90.)

162. Mr. Corrin testified that the "EMB" is limited in how low it can be installed relative to the "G4" primary burner tube by the "EMB's" valve touching the floor. (2 Tr. 198-201.)

163. Mr. Corrin did not testify that the Peterson "EMB" secondary burner tube in Peterson's lab apparatus was installed with its top "below" the primary burner tube or that the top of the primary burner tube in the lab apparatus was installed at a "raised level" with respect to the top of the secondary burner tube. (2 Tr. 198-201; 2 Tr. 164-203.)

164. Mr. Corrin did not testify that the Peterson "EMB" secondary burner product in Peterson's lab was installed in a manner infringing the '159 Patent. (2 Tr. 198-201; 2 Tr. 164-203.)

165. Mr. Corrin did not testify that Peterson or any Peterson dealer or customer, ever installed an "EMB" secondary burner product in a manner which infringed the '159 Patent. (2 Tr. 164-203.)

166. Mr. Corrin did not testify about the manner in which the customers, installers, dealers or anyone else installed an "EMB" secondary burner product with any primary burner. (2 Tr. 164-203.)

167. Mr. Corrin did not testify that Peterson took any actions which encouraged, induced or caused anyone to infringe the '159 Patent. (2 Tr. 164-203.)

168. Mr. John Palaski did not testify that Peterson or any Peterson dealer or customer or anyone else ever installed an "EMB" secondary burner product such that the top of the primary burner was at a "raised level" with respect to the top of the "EMB" product. (2 Tr. 204-241.)

169. Mr. Palaski did not testify that Peterson or any Peterson dealer or customer or anyone else ever installed an "EMB" secondary burner product with its top "below" the top of a primary burner. (2 Tr. 204-241.)

170. Mr. Palaski did not testify that Peterson or any Peterson dealer or customer or anyone else ever installed an "EMB" in a manner which infringed the '159 Patent. (2 Tr. 204-241.)

171. Mr. Palaski did not testify about the manner in which Peterson dealers or customers or anyone else installed any "EMB" product. (2 Tr. 204-241.)

172. Mr. Palaski did not testify that Peterson took any actions which encouraged, induced or caused anyone to infringe the '159 Patent. (2 Tr. 204-241.)

173. Mr. Darryl Dworkin did not testify that Peterson or any Peterson dealer or customer or anyone else ever installed an "EMB" secondary burner product such that the top of a primary burner was at a "raised level" with respect to the top of the "EMB" product (3 Tr. 3-34.)

174. Mr. Dworkin did not testify that Peterson or any Peterson dealer or customer or anyone else ever installed an "EMB" secondary burner product with its top "below" the top of a primary burner. (3 Tr. 3-34.)

175. Mr. Dworkin did not testify that Peterson or any Peterson dealer or customer or anyone else ever installed an "EMB" in a manner which infringed the '159 Patent. (3 Tr. 3-34.)

176. Mr. Dworkin did not testify about the manner in which Peterson dealers or customers or anyone else installed any "EMB" product. (3 Tr. 3-34.)

177. Mr. Dworkin did not testify that Peterson or any Peterson dealer or customer or anyone else ever installed an "EMB" in a manner which infringed the '159 Patent. (3 Tr. 3-34.)

178. Mr. Dworkin did not testify that Peterson took any actions which encouraged, induced or caused anyone to infringe the '159 Patent. (3 Tr. 3-34.)

179. Peterson called no other witnesses.

180. None of Peterson's witnesses testified about any installation by Peterson or any Peterson dealer or customer or anyone else of a Peterson "EMB" product and any primary burner tube in which the top of the primary burner tube was installed at a "raised level" with respect to the top of the secondary burner tube.

181. None of Peterson's witnesses testified about any installation by Peterson or any Peterson dealer or customer or anyone else of a Peterson "EMB" product and any primary burner in which the top of the secondary burner tube was installed "below" than the top of the primary burner tube.

182. None of Peterson's witnesses testified about any installation by Peterson or any Peterson dealer or customer or anyone else of Peterson "EMB" product in a manner which infringes the '159 Patent.

183. None of Peterson's exhibits proved any installation by Peterson or any Peterson dealer or customer or anyone else of a Peterson "EMB" product and any primary burner in which the top of the primary burner tube was installed at a "raised level" with respect to the top of the secondary burner tube.

184. None of Peterson's exhibits proved any installation by Peterson or any Peterson dealer or customer or anyone else of a Peterson "EMB" product and any primary burner in which the top of the secondary burner tube was installed "below" the top of a primary burner tube.

185. None of Peterson's exhibits proved any installation by Peterson or any Peterson dealer or customer or anyone else of a Peterson "EMB" product in a manner which infringes the '159 Patent.

NO EVIDENCE OF CONTRIBUTORY INFRINGEMENT.

186. Plaintiff offered no substantial or competent evidence that any Peterson dealer, customer or anyone else ever installed or attached a Peterson "EMB" product in a manner which infringed the '159 Patent.

187. The top of Peterson's "EMB" secondary burner product could be installed level with or above the top of a primary burner to which it was attached by tightening the female pipe fitting with a wrench while the top of the "EMB" was positioned level with or above the top of the primary burner. (PX 7, p.3).

188. Any installation of an "EMB" product in which its top is level with or above the top of the primary burner does not infringe independent Claim 1 or dependent Claims 2 through 16 of the '159 Patent, all of which require a primary burner tube installed at a "raised level" with respect to the secondary burner tube.

189. No dependent claim of the '159 Patent is infringed unless the accused device exhibits every element of the independent claim upon which it is based. (1 Tr. 50.)

190. Any installation of an "EMB" product in which its top is level with or above the top of the primary burner does not infringe Claim 17 of the '159 Patent, which requires a secondary burner tube installed "below" a primary burner tube.

191. Because Peterson's "EMB" product is capable of being installed in a non-infringing manner, it has substantial non-infringing uses.

192. No substantial evidence shows that Peterson's "EMB" product has no substantial non-infringing uses.

193. Because Peterson's "EMB" product is capable of being installed in a non-infringing manner, it constitutes a "staple article of commerce" as that term is used in the patent law.

194. When plaintiff asked Mr. Blount whether "there's no other use for your ember burner or that assembly other than a gas fireplace" and whether "it's not a staple article of commerce," Mr. Blount was testifying about plaintiff's ember burner device, not Peterson's "EMB" product. (1 Tr. 76; *see also*, 1 Tr. 68.)

195. Mr. Blount was never asked and did not testify whether there were non-infringing uses for Peterson's "EMB" product.

196. Mr. Blount was never asked and did not testify whether Peterson's "EMB" product was a "staple article of commerce."

197. Given Mr. Blount's admitted lack of personal knowledge about how Peterson's products were made, used or sold and how Peterson's "EMB" product was installed by customers or others, he could not have competently testified about whether the "EMB" had substantial non-infringing uses or whether it was a "staple article of commerce." (1 Tr. 68, 121, 129.)

198. When Mr. Bortz was asked whether Peterson's "EMB" product was a "staple article of commerce," he answered, "I don't know what that means." (2 Tr. 67.)

199. Mr. Bortz lacks sufficient personal knowledge to testify competently whether or not the Peterson "EMB" product constitutes a "staple article of commerce" as that term is used in the patent law.

200. Mr. Bortz did not testify that Peterson's "EMB" product had no substantial non-infringing uses. (2 Tr. 39-100.)

201. No substantial evidence shows that Peterson's "EMB" product was especially made for use in the patented combination claimed in the '159 Patent.

202. No substantial evidence shows that Peterson knew that its "EMB" product was especially made for use in the patented combination claimed in the '159 Patent.

NO EVIDENCE OF INDUCED INFRINGEMENT.

203. Plaintiff offered no substantial or competent evidence that any Peterson dealer, customer or anyone else ever installed any Peterson "EMB" product in a manner which infringed the '159 Patent.

204. Peterson's standard installation instructions distributed with its "EMB" product do not suggest that the "EMB" secondary burner be installed with its top "below" the top of a primary burner or that the "EMB" be installed such that the top of the primary burner remains at a "raised level" with respect to the top of the "EMB" product. (PX 7.)

205. Following Peterson's standard installation instructions does not inevitably lead to an installation of the "EMB" secondary burner with its top "below" the top of the primary burner. (PX 7.)

206. Following Peterson's standard installation instructions does not inevitably lead to an installation of the "EMB" secondary burner such that the top of the primary burner remains at a "raised level" with respect to the top of the "EMB" product. (PX 7.)

207. The only other Peterson literature distributed to customers offered into evidence by plaintiff also does not suggest that the top of the "EMB" secondary burner be installed "below" the top of the primary burner or that the "EMB" be installed such that the top of the primary burner remains at a "raised level" with respect to the top of the "EMB" product. (PX 6, 23.)

208. Plaintiff offered no other evidence of affirmative actions or communications by Peterson that induced anyone to install the "EMB" secondary burner such that the top of the primary burner remains at a "raised level" with respect to the top of the "EMB" product.

209. Plaintiff offered no other evidence of affirmative actions or communications by Peterson that induced anyone to install the "EMB" secondary burner with its top "below" the top of the primary burner.

210. Plaintiff offered no substantial evidence that Peterson knew that any of its actions or communications would cause anyone to install the "EMB" secondary burner such that the top of the primary burner remains at a "raised level" with respect to the top of the "EMB" product.

211. Plaintiff offered no substantial evidence that Peterson knew that any of its actions or communications would cause anyone to install the "EMB" secondary burner with its top "below" the top of the primary burner.

NO EVIDENCE OF DAMAGES.

212. Because plaintiff failed to prove any form of infringement, it is not entitled to any damages.

213. Plaintiff offered no proof of its consistent product marking at any time.

214. Even were plaintiff entitled to some award of damages, the evidence is insufficient to establish that, without Peterson's sales of "EMB" accessory products, plaintiff would have made any additional sales of its own products.

215. Many "EMB" products were sold to "people who had previously purchased G4 burner systems" to retrofit those existing Peterson systems. (2 Tr. 176.)

216. By law, both Peterson's and plaintiff's products are required to meet ANSI safety standards. (PX 1 at col. 1, lns. 59-61.)

217. No substantial evidence shows that plaintiff's secondary burner was certified or listed by ANSI for use with or as an accessory to Peterson's "G4" primary burner.

218. Thus, a Peterson customer having an existing "G4" installation who desired an ember burner could not consider plaintiff's product unless that customer first removed his existing Peterson equipment.

219. No substantial evidence shows that, had Peterson been unable to offer the "EMB" product, any Peterson customer would have removed their existing Peterson equipment to replace it with plaintiff's entire combination unit.

220. The "EMB" is suitable for installation only as an accessory to Peterson "G4" or "G5" primary burners. (PX 7.)

221. The EMB installation instructions explicitly state that they can only be used with Peterson "G4" primary burners. (PX 7.)

222. No substantial evidence shows that Peterson's "EMB" was ever certified or listed for use by ANSI with plaintiff's primary burner.

223. Thus, no sale of a Peterson "EMB" accessory product could have prevented plaintiff from selling one of its own accessory products to an existing customer of plaintiff's who desired to retrofit his existing primary burner with a secondary ember burner.

224. Plaintiff established that 97.5% of its own sales were entire new fireplace installations (*i.e.*, primary and secondary burners in one package). (1 Tr. 160-61.)

225. Plaintiff failed to present any substantial evidence showing how many sales of Peterson "EMB" products were for entirely new fireplace installations

226. Plaintiff failed to present any substantial evidence showing how many additional new fireplace installations it would have made but for the sales of Peterson's "EMB" product.

227. Peterson first marketed the "EMB" in the 1996 season. (2 Tr. 75-6.)

228. Peterson first offered the "EMB" by catalog in March 1997. (2 Tr. 75-6.)

229. Peterson sold the following number of "EMB's" during the following time periods after the issuance of the '159 Patent:

<u>Beginning</u>	<u>Ending</u>	<u>Quantity</u>
11/23/99	12/16/99	288
12/16/99	5/3/00	470
5/3/00	8/9/02	3253

(PX 17; *see also* Peterson Co.'s Objection to Golden Blount's Mot. For Updated Damages.)

230. After it was enjoined by this Court, Peterson repurchased 802 EMB's from distributors which had not been sold to end user customers. (PX 17; *see also* Peterson Co.'s Objection to Golden Blount's Mot. For Updated Damages.)

231. None of the EMB products repurchased by Peterson from distributors and thus withdrawn from the market could possibly have caused plaintiff to lose any sales of its own products.

232. Plaintiff offered with Mr. Blount Plaintiff's Exhibit 18, a demonstrative chart purporting to show the costs and profit margins of plaintiff's products. (PX 18.)

233. Mr. Blount did not testify that he prepared Plaintiff's Exhibit 18. (1 Tr. 66-7; PX 18; *see also* 1 Tr. 26-149, 3 Tr. 35-42.)

234. Mr. Blount did not testify was the custodian of the financial records from which Plaintiff's Exhibit 18 was prepared. (1 Tr. 66-7; PX 18; *see also* 1 Tr. 26-149, 3 Tr. 35-42.)

235. Mr. Blount did not testify that, to his personal knowledge, the amounts shown on Plaintiff's Exhibit 18 accurately depicted the various costs, prices and profit margins shown on the exhibit. (1 Tr. 66-7; PX 18; *see also* 1 Tr. 26-149, 3 Tr. 35-42.)

236. No other witness having personal knowledge of plaintiff's various costs, prices and profit margins testified that the values shown on Plaintiff's Exhibit 18 accurately depicted plaintiff's actual costs, prices and profit margins.

237. Plaintiff failed to present any substantial evidence that it ever sold its secondary burner accessory individually at the price represented on Plaintiff's Exhibit 18.

238. Plaintiff failed to present any substantial evidence showing that the profit margins for either the ember burner as an accessory or for plaintiff's complete product are accurately depicted by the margins represented on Plaintiff's Exhibit 18. (1 Tr. 66-7; PX 16; PX 18.)

239. Mr. Blount admitted that plaintiff's profit margin calculations as shown on Plaintiff's Exhibit 18 did not include sales costs or overhead, except for a small allowance for utilities. (1 Tr. 139-40.)

240. Mr. Blount claimed that plaintiff did not have any sales or overhead costs. (1 Tr. 139-40.)

241. Mr. Blount's claim is inherently improbable and unworthy of belief.

242. Mr. Blount submitted invoices to the Patent Office to establish commercial success. (DX 3 at 000219-230.)

243. Those invoices show the names of salespersons, indications of freight charges and offer a 10% discount for payment within 30 days. (DX 3 at 000219-230.)

244. Those invoices show that plaintiff did in fact have sales and overhead costs. (DX 3 at 000219-230.)

245. Mr. Blount and Mr. Hanft admitted that there are at least five other products on the market that perform roughly the same function as plaintiff's device. (1 Tr. 63, 162.)

246. Mr. Hanft testified that he had “heard that some [ember burners that provide the same result as plaintiff’s device] exist.” (1 Tr. 162.).

247. Mr. Hanft further testified that “it’s important to know that I have no incentive to go to try to find them.” (1 Tr. 162.)

248. Plaintiff failed to present any substantial evidence showing any of those substitute products to be infringing.

249. Plaintiff failed to present any substantial evidence that it brought an infringement suit regarding any of the substitute products on the market other the Peterson’s “EMB” product.

250. Each of the other products on the market that perform roughly the same function as plaintiff’s device and patented invention are non-infringing substitutes.

251. Peterson also manufactures and sells the “Front Flame Director” as an accessory for the “G4” burner. (2 Tr. 184; DX 26.)

252. The “Front Flame Director” is less expensive than the “EMB” and works differently. (2 Tr. 184-5.)

253. Plaintiff does not claim and did not offer any evidence to prove that Peterson’s “Front Flame Director” infringes the ‘159 Patent.

254. Peterson’s distributors sold both the “Front Flame Director” and the “EMB,” although a customer would only use one or the other, not both. (2 Tr. 185.)

255. The “Front Flame Director” has been in existence longer than the “EMB,” having been on sale for more than 10 years. (2 Tr. 188, 195.)

256. The “Front Flame Director” provides the same function and effect as the “EMB” – to produce a front flame effect. (2 Tr. 188, 195.)

257. The "Front Flame Director" is a non-infringing substitute for plaintiff's patented secondary burner tube.

258. Plaintiff offered no substantial evidence from which a reasonable royalty could properly be calculated.

NO EVIDENCE OF WILLFULNESS

259. The '159 Patent was issued on November 23, 1999. (PX 1.)

260. Peterson first became aware of the Patent's existence by letter dated and sent on or about December 16, 1999 and received thereafter. (Substitute Stmt. of Stipulated Facts at ¶9; PX 10.)

261. Because Peterson's "EMB" product was first introduced in 1996, it could not be a copy of the invention described in the later issued '159 Patent. (2 Tr. 75-6.)

262. Although Mr. Blount claimed that Peterson had copied his patented invention, his admitted lack of personal knowledge about how Peterson designs, makes, uses and sells its products renders this testimony insufficient to prove conscious copying by Peterson. (1 Tr. 30, 68, 121, 129.)

263. No witness having personal knowledge of Peterson's design, manufacture and offering of the "EMB" product for sale testified that Peterson had consciously copied plaintiff's patented invention.

264. Peterson is not shown to have obtained possession of an example of plaintiff's ember burner product prior to 1996 or at any time or to have tested or "reverse engineered" it.

265. Upon receipt of the December 16, 1999 letter informing Peterson of the existence of the '159 Patent, Mr. Bortz contacted the company's long-term patent attorney Mr. F. William McLaughlin about how to respond. (1 Tr. 168-9; PX 10; 2 Tr. 43-4.)

266. Mr. McLaughlin has a BS in electrical engineering from the University of Notre Dame and law degree from DePaul University. (1 Tr. 194.)

267. Mr. McLaughlin began practicing law in January 1985. (1 Tr. 194.)

268. Mr. McLaughlin specializes in intellectual property, is admitted to practice before the patent office, has prosecuted between four and five hundred patent applications and has conducted appeals before the PTO. (1 Tr. 194-201.)

269. Mr. McLaughlin has prepared approximately 100 non-infringement opinions and prepared 24-36 invalidity opinions, including oral opinions. (1 Tr. 195-6.)

270. Peterson has been represented by Mr. McLaughlin since 1990, and by his firm since before then. (1 Tr. 203.)

271. McLaughlin testified, that the December 16, 1999 letter was:

carefully crafted specifically to not be an infringement charge and that the type of letter an attorney will frequently draft to avoid the other side going ahead and filing a declaratory judgment action.

(1 Tr. 199.)

272. Neither Mr. Bortz nor Mr. McLaughlin believed the December 16, 1999 letter to be a charge of infringement. (1 Tr. 170; 2 Tr. 43.)

273. The December 16, 1999 letter was not a charge of infringement.

274. Mr. Bortz provided Mr. McLaughlin documentation including instructions and working drawings for the Peterson EMB and had discussions with him regarding the assembly. (1 Tr. 198-9; 2 Tr. 9-13; DX 22; DX 34.)

275. At Mr. McLaughlin's direction, Peterson responded to the December 16, 1999 letter on December 30, 1999. (PX 13.)

276. Plaintiff sent Peterson a second letter dated May 3, 2000. (PX 12.)

277. The May 3, 2000 letter contained, for the first time, a broad claim of infringement. Peterson forwarded this letter to McLaughlin. (1 Tr. 200; 2 Tr. 51; DX 19.)

278. In response, Peterson sent a letter on May 16, 2000 requesting a more detailed explanation of the basis for the infringement claim. (1 Tr. 201; 2 Tr. 51; PX 13.)

279. Mr. McLaughlin advised Peterson to request an explanation because the May 3, 2000 letter "simply had a broad infringement allegation, and he wanted a greater explanation from Golden Blount as to why Golden Blount thought the Peterson Company was infringing the patent." (1 Tr. 178; 2 Tr. 56.)

280. Peterson received no response from plaintiff for over 7 months. (2 Tr. 56-7.)

281. The response was the Complaint, which was served upon Peterson shortly after its filing on January 18, 2001. (2 Tr. 57.)

282. Peterson forwarded the Complaint to Mr. McLaughlin. (1 Tr. 202; 2 Tr. 57-8.)

283. Mr. McLaughlin told Peterson that a file history and cited references would need to be ordered and a prior art search would have to be done. (1 Tr. 202.)

284. Mr. McLaughlin obtained the file wrapper for the '159 Patent. (1 Tr. 202-3.)

285. Peterson found and forwarded to Mr. McLaughlin examples of prior art in its files. (DX 22; DX 23; DX 33; DX 34; DX 35; DX 43; DX 44; DX 45; DX 46.)

286. Included in the materials sent to McLaughlin were: a diagram of an F3 depicting multiple burners and multiple valves as well as one burner higher than another, which Peterson had been selling since prior to 1977, historical advertising materials and price lists, diagrams dated July 1, 1983 showing an adjustable valve between two burners and, a diagram of the Glowing Ember Gas Log Set. (1 Tr. 204-11; DX 22; DX 23; DX 48.)

287. Mr. McLaughlin testified he gave Peterson three specific opinions concerning the '159 Patent. These opinions were given in December 1999, February 2001 and May 2001. (1 Tr. 196.)

288. Mr. McLaughlin opined that there were reasons to believe the Patent was invalid and reasons to believe that Peterson was not infringing. (2 Tr. 63-4.)

289. Mr. McLaughlin's December 1999 opinion was that "if we can prove that what the Peterson Company was doing with the present product, the ember flame booster for 20 or 30 years, then either they would not infringe any claim, which would be a different issue or if they infringed, that claim would be invalid." (1 Tr. 196-7.)

290. Mr. McLaughlin's February 2001 opinion was "The Peterson ember flame booster did not literally infringe any claim of the Blount patent, and at least some of the claims were invalid at least as obvious and possibly in anticipation." (1 Tr. 181, 197.)

291. Mr. McLaughlin's May 2001 opinion, was that Peterson did "not perform substantially the same function in substantially the same way to produce substantially the same result." (1 Tr. 183, 197.)

292. McLaughlin's third opinion specifically included that Claim 1 was barred under 35 U.S.C. § 103 and that claim 19 was obvious and anticipated. (1 Tr. 191.)

293. Peterson was also told by Mr. McLaughlin that:

[N]one of the claims were literally infringed. That at least with respect to claims 1 through 18 they were not infringed under the doctrine of equivalence. Claim 19 was anticipated, again subject to proving prior art, and the remaining claims of the patent were all invalid as obvious.... And I also discussed some of the prior art, why they were invalid is obvious.

(1 Tr. 197.)

294. Mr. McLaughlin put his opinion in writing to the extent that he drafted the response to Interrogatories 1 and 3, which requested an identification of claim limitations for claims 1, 17 and 19 not contained in the EMB. (2 Tr. 6; DX 61.)

295. Mr. McLaughlin drafted his responses based on prior art, file history and the opinion he gave to Peterson. (2 Tr. 7; DX 61.)

296. Mr. Bortz testified that the interrogatory answers drafted in May 2001 reflected the opinions received by Peterson from Mr. McLaughlin. (2 Tr. 86; DX 61.)

NO EVIDENCE THAT WARRANTS ENHANCED DAMAGES.

297. Plaintiff presented no evidence of conscious copying by Peterson.

298. Peterson did obtain non-infringement opinions in this case.

299. Upon receipt of plaintiff's December 16, 1999 letter, Peterson immediately sought legal advice from Mr. McLaughlin.

300. In particular, Peterson was advised by its patent counsel, Mr. McLaughlin in February, 2001 that the "EMB" product did not literally infringe any claim of the '159 Patent. (1 Tr. 181, 197.)

301. Although Mr. McLaughlin's opinion was oral, even a simple analysis quickly reveals that because Peterson was then selling its "EMB" and "G4" products in separate, unassembled packages, none of those sales could infringe the '159 Patent until someone assembled the products in an infringing configuration. (DX 31; DX 32.)

302. Even a simple analysis also quickly showed that because Peterson's "EMB" product was capable of being installed with its top level with or above the top of a primary burner, the "EMB" product had substantial non-infringing uses.

303. Because the length of the valve stem extending from Peterson's "EMB" secondary burner physically limited the installation such that the lowest possible configuration was roughly level with top of the primary burner tube, Peterson was convinced that no infringement by its customers was occurring. (2 Tr. 198-201; 3 Tr. 36-7.)

304. Even a simple analysis also revealed that following Peterson's standard installation instructions for the "EMB" product would not inevitably lead to an infringing installation of that product.

305. Peterson relied upon Mr. McLaughlin's opinions. (2 Tr. 40, 50; 55.)

306. Given the facts concerning Peterson's separate sales of its "EMB" and "G4" products and the depression limitation of the valve stem, it was reasonable for Peterson to rely on Mr. McLaughlin's non-infringement opinions.

307. It was reasonable for Peterson and Mr. McLaughlin to conclude from these facts that Peterson could continue to manufacture and sell "G4" and "EMB" products without infringing the '159 Patent, either directly or indirectly.

308. Peterson consistently consulted with an attorney who was more than qualified to render such advice.

309. This record does not show dilatory conduct on Peterson's part.

310. No substantial evidence suggests that any of Mr. McLaughlin's opinions were offered or intended as a ruse.

311. Nothing suggests that Peterson should have known to push McLaughlin for an earlier or more formal opinion.

EXCEPTIONAL CASE.

312. No clear and convincing evidence shows that Peterson engaged in willful infringement by continuing to make, use and sell its separately packaged "G4" and "EMB" products after it was charged with infringing the '159 Patent.

313. Because each claim of the '159 Patent requires a combination of a primary and secondary burner, it was obvious that Peterson did not literally infringe any claim the '159 Patent by continuing to sell separate primary and secondary burner component products after it was charged with infringing the '159 Patent.

314. No clear and convincing evidence shows that Peterson engaged in willful infringement by assembling a combination of its "G5" and "EMB" products in an infringing manner after the '159 Patent issued on November 23, 1999.

315. Because Peterson's primary and secondary burner components both have substantial non-infringing uses, it was obvious that Peterson did not contributorily infringe any claim the '159 Patent by continuing to sell these components products after it was charged with infringing the '159 Patent.

316. Because Peterson's "EMB" secondary burner product has substantial non-infringing uses, it was obvious that this product was not especially made for use in a patented combination claimed in the '159 Patent.

317. Because none of Peterson's standard installation instructions or other literature distributed to customers regarding its "EMB" product suggest, instruct or encourage an infringing installation of the "EMB" product, it was obvious that Peterson could continue marketing that product using these materials after it was charged with infringing the '159 Patent without willfully committing induced infringement.

318. No clear and convincing evidence shows that Peterson engaged in any form of misconduct during this litigation.

319. No clear and convincing evidence shows that Peterson engaged in any form of vexatious or unjustified litigation.

320. Because it was or should have been obvious to plaintiff early in this litigation that Peterson did not literally infringe any claim of the '159 Patent by selling separately the "G4" and "EMB" products or by selling a "G5" product which did not include an "EMB" accessory or by selling a "G5" product with an "EMB" accessory installed level with or above the primary burner, plaintiff engaged in vexatious or unjustified litigation. (DX 65, Answer 1.)

321. Because plaintiff offered no evidence that any Peterson dealer or customer or any third party had ever installed an "EMB" product in a manner which infringed any claim of the '159 Patent, it was or should have been obvious to plaintiff early in this litigation that it could not prove either contributory or induced infringement.

322. Because plaintiff obtained through discovery the literature and communications product which Peterson distributes to customers concerning the "EMB," it was or should have been obvious to plaintiff early on in this litigation that it could not prove that Peterson had taken any affirmative actions to induce others to infringe the '159 Patent.

323. When plaintiff elected to continue its infringement claims after it knew or should have known that it could not prove either contributory or induced infringement, plaintiff engaged in vexatious or unjustified litigation.

324. Plaintiff's continuation of vexatious or unjustified infringement claims against Peterson warrant a finding that Peterson is entitled to recover reasonable attorney's fees in an amount to be shown by a fee petition to be filed by Peterson.

CONCLUSIONS OF LAW

EVIDENCE AND BURDEN.

1. Plaintiff bears the burden of proving its claim for patent infringement by a preponderance of the evidence. *Biovail Corp. Intern'l. v. Andrx Pharmaceuticals, Inc.*, 239 F.3d 1297, 1302 (Fed. Cir. 2001).

2. Plaintiff bears the burden of proving its claim for willful patent infringement by clear and convincing evidence. *E.I. DuPont de Nemours & Co. v. Phillips Petroleum Co.*, 849 F.2d 1430, 1441 (Fed. Cir. 1988); *Shatterproof Glass Corp. v. Libbey-Owens Ford Co.*, 758 F.2d 613, 628 (Fed. Cir. 1985).

3. Plaintiff bears the burden of proving its claim that this is an exceptional case by clear and convincing evidence. *Cambridge Products, Ltd. v. Penn Nutrients, Inc.*, 962 F.2d 1048, 1050 (Fed. Cir. 1992); *Reactive Metals and Alloys Corp. v. ESM Inc.*, 769 F.2d 1578, 1582 (Fed. Cir. 1985).

4. Findings of fact must be supported by substantial evidence. *Lame v. United States Dep't of Justice*, 767 F.2d 66, 70 (3d Cir. 1985) (factual findings clearly erroneous if unsupported by substantial evidence, lack adequate evidentiary support, or against clear weight of evidence).

5. Substantial evidence is such relevant evidence as might be accepted by a reasonable mind as adequate to support the finding under review. *Juicy Whip, Inc. v. Orange Bang, Inc.*, 292 F.3d 728, 736 (Fed. Cir. 2002); *Perkin-Elmer Corp. v. Computervision Corp.*, 732 F.2d 888, 893 (Fed. Cir. 1984).

6. If a finding is directly contrary to the only testimony presented, it is properly considered to be clearly erroneous. *Trans-Orient Marine Corp. v. Star Trading & Marine, Inc.*, 925 F.2d 566, 571 (2nd Cir. 1991).

7. No witness other than an expert witness may testify to any matter unless it is first shown that the witness has personal knowledge of the matter. Rule 602, F.R.Evid.

8. Because plaintiff called no expert witness, the reasonable inferences which may be drawn from the testimony of the lay witnesses who did testify is limited to the scope of their personal knowledge and rational perception. Rule 701, F.R.Evid.; *United States v. Hoffner*, 777 F.2d 1423, 1426 (10th Cir. 1985) (“After learning that none of the witnesses had been present in the examining room when any of the patients who had received the improper prescriptions were with Dr. Hoffner, the court concluded that their opinions as to the doctor’s intent were not based on any rational perceptions or observations. We agree.”).

9. Demonstrative exhibits, including models, charts and videotapes, have no independent evidentiary value higher than the testimony which supports them. Wright & Miller, FED. PRAC. & PROC., EVIDENCE, § 5163, p. 36; 3 Wigmore, EVIDENCE, Chadbourn Rev. (1970), p. 218 (map, diagram or model without supporting testimony is “for evidential purposes, simply *nothing*” Emphasis original).

10. Demonstrative exhibits, including models, charts and videotapes, must be authenticated by competent evidence to show that the matter in question is what the proponent claims. Rule 901(a), F.R.Evid.; *Renfro Hosiery Mills Co. v. National Cash Register Co.*, 552 F.2d 1061, 1065 (4th Cir. 1977) (“[T]he relevance of experimental evidence depends on whether or not the experiment was performed under conditions ‘substantially similar’ to those of the actual occurrence sought to be proved.”).

11. The burden of satisfying the court as to the admissibility and relevance of demonstrative evidence rests with the proponent of that evidence. *Renfro Hosiery*, 552 F.2d at 1065-66.

12. Because plaintiff offered no substantial evidence showing that Plaintiff's Exhibit 4A (plaintiff's physical example of primary and secondary burners assembled together) was in fact: (i) made or sold by Peterson, or (ii) an assembly of components made or sold by Peterson, or (iii) assembled by Peterson, there is no evidence to authenticate Plaintiff's Exhibit 4A as accurately depicting any Peterson product or products. F.R.Evid. 901(a).

13. Because plaintiff offered no substantial evidence to authenticate Plaintiff's Exhibit 4A as accurately depicting any Peterson product or products, this exhibit is insufficient to prove infringement of the '159 Patent by Peterson.

14. Because plaintiff offered no substantial evidence to authenticate Plaintiff's Exhibit 4A as accurately depicting Peterson component products assembled by a Peterson dealer or customer, this exhibit is insufficient to prove infringement of the '159 Patent by any third party.

15. Because plaintiff offered no substantial evidence establishing that the photograph shown on Plaintiff's Exhibit 5A in fact illustrates any Peterson product or products assembled by Peterson or by any Peterson dealer or customer in the configuration shown, there is no evidence to authenticate these pictures as accurately depicting any Peterson product or products. F.R.Evid. 901(a).

16. Because plaintiff offered no substantial evidence to authenticate Plaintiff's Exhibit 5A as containing an accurate portrayal of any Peterson products assembled in an infringing manner (*i.e.*, with the primary burner tube at a "raised level" with respect to the

secondary burner tube, which was installed “below” the primary burner tube), this exhibit is insufficient to prove infringement of the ‘159 Patent by Peterson or any Peterson dealer or customer or anyone else.

17. Because plaintiff offered no substantial evidence showing that any of the pictures shown in Plaintiff’s Exhibit 8 (plaintiff’s video tape) in fact illustrate any Peterson product or products assembled either by Peterson or by any Peterson dealer or customer in the configuration as shown on the video tape, there is no evidence to authenticate any of these pictures as accurately depicting any Peterson product or products. F.R.Evid. 901(a).

18. Because plaintiff offered no substantial evidence to authenticate Plaintiff’s Exhibit 8 as containing any accurate portrayals of any Peterson product or products, this exhibit is insufficient to prove infringement of the ‘159 Patent by Peterson or any Peterson dealer or customer or anyone else.

19. Because plaintiff offered no substantial evidence to authenticate Plaintiff’s Exhibit 8 as containing any accurate portrayals of Peterson products assembled in an infringing manner (*i.e.*, with the primary burner tube at a “raised level” with respect to the secondary burner tube, which was installed “below” the primary burner tube), this exhibit is insufficient to prove infringement of the ‘159 Patent by Peterson or by any Peterson dealer or customer or by anyone else.

20. Because plaintiff did not call the narrator whose voice was heard on the videotape as a witness available for cross examination, each of the narrator’s statements on the audio track of the video tape constitute inadmissible hearsay. F.R.Evid. 801(c).

21. Because plaintiff offered no substantial evidence establishing that the drawings labeled “Defendant’s Sold Device” shown on Plaintiff’s Exhibit 9 (plaintiff’s “Literal

Infringement Chart”) in fact illustrate any Peterson product or products assembled by Peterson or by any Peterson dealer or customer in the configuration shown, there is no evidence to authenticate these drawings as accurately depicting any Peterson product or products. F.R.Evid. 901(a).

22. Because plaintiff offered no substantial evidence to authenticate Plaintiff’s Exhibit 9 as containing drawings accurately depicting any Peterson product or products, this exhibit is insufficient to prove infringement of the ‘159 Patent by Peterson or by any Peterson dealer or customer or by anyone else.

23. Because Plaintiff produced neither the person who created Plaintiff’s Exhibit 18 to authenticate it, nor the custodian of its financial records which Plaintiff’s Exhibit 18 purports to summarize to testify that they were regularly kept in the ordinary course of plaintiff’s business nor did plaintiff follow the certificate procedure set forth in F.R.Evid. 902(11) and (12), Plaintiff’s Exhibit 18 has no probative value. F.R.Evid., 803(6), 901(a), 902(11) and (12).

24. Because plaintiff offered no substantial evidence establishing that the drawings labeled “Defendant’s Sold Device” shown on Plaintiff’s Exhibit 21 (plaintiff’s “Equivalence Chart”) in fact illustrate any Peterson product or products assembled by Peterson or by any Peterson dealer or customer in the configuration shown, there is no evidence to authenticate these drawings as accurately depicting any Peterson product or products. F.R.Evid. 901(a).

25. Because plaintiff offered no substantial evidence to authenticate Plaintiff’s Exhibit 21 as containing drawings accurately depicting any Peterson product or products, this exhibit is insufficient to prove infringement of the ‘159 Patent by Peterson or any Peterson dealer or customer or anyone else.

26. Because plaintiff offered no substantial evidence establishing that the drawings shown on Plaintiff's Exhibit 22 in fact illustrate any Peterson product or products assembled by Peterson or any Peterson dealer or customer or anyone else in the configuration shown, there is no evidence to authenticate these drawings as accurately depicting any Peterson product or products. F.R.Evid. 901(a).

27. Because plaintiff offered no substantial evidence to authenticate Plaintiff's Exhibit 22 as drawings accurately depicting any Peterson product or products; this exhibit is insufficient to prove infringement of the '159 Patent by Peterson or any Peterson dealer or customer or anyone else.

28. Because Mr. Golden Blount and Mr. Charles Hanft both admitted that they have no personal knowledge concerning how Peterson sells its "G4," "G5" and "EMB" products, their testimony cannot authenticate any of plaintiff's demonstrative exhibits, to the extent that such exhibits purport to depict those products. F.R.Evid, 901(b)(1) (witness with personal knowledge can authenticate); *U.S. v. Van Wyhe*, 965 F.2d 528, 532 (7th Cir. 1992) (in order to lay proper foundation for a book containing a photograph, the defendant was "required to call a witness who had . . . knowledge of the book or photograph.").

29. The admission of these demonstrative exhibits into evidence only means that the trier of fact may consider them in its deliberations. 5 WEINSTEIN'S FED. EVID., § 901.02[3] at 901-16-17; *U.S. v. Branch*, 970 F.2d 1368, 1370 (4th Cir. 1992) ("the jury ultimately resolves whether evidence admitted for its consideration is that which the proponent claims").

30. Even admitted evidence cannot have any probative value unless it is actually what it is purported to be. 5 WEINSTEIN'S FED. EVID., § 901.02[2] at 901-11; *U.S. v. Hernandez-Herrera*, 952 F.2d 342, 343 (10th Cir. 1991) ("The rationale for the authentication requirement is

that the evidence is viewed as irrelevant unless the proponent of the evidence can show that the evidence is what its proponent claims.”); *U.S. v. Papia*, 910 F.2d 1357, 1366 (7th Cir. 1990) (“On the other hand, if the note was not Papia’s, the note would be irrelevant to her state of mind.”).

31. Although Mr. Blount gave detailed testimony comparing the claimed elements of the ‘159 Patent to the “Defendant’s Sold Device” drawings appearing in Plaintiff’s Exhibit 9, such testimony has no probative value absent evidence establishing that Plaintiff’s Exhibit 9 accurately portrays a product or combination of products made, used or sold by Peterson or products assembled by any Peterson dealer or customer or anyone else.

32. Mr. Blount’s admitted lack of personal knowledge about how Peterson sells its products and how Peterson’s customers install them renders irrelevant his testimony comparing any Peterson product to the claimed elements of the ‘159 Patent.

33. Proof that an exhibit is what it purports to be is necessary to show the exhibit to be trustworthy. 5 WEINSTEIN’S FED. EVID., § 901.02[2] at 901-12.

34. Because there is no authentication evidence showing that any of plaintiff’s demonstrative exhibits accurately depict any Peterson product or combination of Peterson products assembled by Peterson or by any dealer or customer, these exhibits are all irrelevant to the question of whether Peterson or any dealer or customer or anyone else infringed the ‘159 Patent. F.R.Evid. 401.

LITERAL INFRINGEMENT AND CLAIM CONSTRUCTION.

35. In order to establish literal infringement by defendant, plaintiff must prove that defendant, acting without authority, made, used or sold a device or product which infringes the ‘159 Patent. 35 U.S.C. § 271(a).

36. Each element contained in a patent claim is deemed material to defining the scope of the patented invention. *Warner-Jenkinson Company, Inc. v. Hilton Davis Chemical Co.*, 520 U.S. 17, 29 (1997).

37. Each stated element in any patent claim constitutes a limitation or narrowing of the scope of that claim. *Pennwalt Corp. v. Durand-Wayland, Inc.*, 833 F.2d 931, 949 (Fed. Cir. 1987) (Nies, J., concurring, *citing* D. Chisum, *Patents* § 18.03[4] (1986)).

38. Where a limitation of any claim is lacking in the accused device exactly or equivalently, there is no infringement. *Biovail*, 239 F.3d at 1302 (Fed. Cir. 2001) (Patentee must prove “that every limitation of the asserted claim is literally met”); *Pennwalt*, 833 F.2d at 949-50 (Fed. Cir. 1987) (Nies, J., concurring, *citing Prouty v. Draper*, 41 U.S. (16 Pet.) 335 (1842) for the “All Elements” Rule).

39. The only independent claims of the ‘159 Patent at issue in this case are Claims 1 and 17. The remaining claims of the ‘159 Patent at issue are all dependent claims, none of which can be infringed unless the independent claims upon which they are all based are also infringed.

40. The limitations of Claim 1 of the ‘159 Patent require an “elongated primary burner tube and secondary coals burner elongated tube communicating through tubular connection means . . .” ‘159 Patent, Col. 7, lines 8-10.

41. The limitations of Claim 1 of the ‘159 Patent also require “a support means for holding the elongated primary burner tube in a raised level relative to the forwardly position secondary burner elongated tube.” ‘159 Patent, Col. 7, lines 3-5.

42. The limitations of Claim 17 of the ‘159 Patent also require a “secondary burner tube positioned substantially parallel, forward and below the primary burner tube.” ‘159 Patent, Col. 8, lines 37-38.

43. The vertical limitations of Claims 1 and 17 should be construed similarly and the tops of the burner tubes should be used to determine whether the secondary burner tube is positioned “below” the primary burner tube (Claim 17) or positioned such that the primary burner tube is at a “raised level” with respect to the secondary burner tube (Claim 1). *Golden Blount, Inc. v. Robert H. Peterson Co.*, 365 F.3d 1054, 1059 (Fed. Cir. 2004).

44. Because of these limitations, the ‘159 Patent is not literally infringed by any product or device which does not contain: (i) both a primary and a secondary burner tube and (ii) in which the primary burner tube is positioned with its top at a “raised level” with respect to the top of the secondary burner tube (Claim 1) or in which the top of the secondary burner tube is positioned “below” the top of the primary burner tube (Claim 17).

45. Because Peterson’s “EMB” product, as made, used and sold by Peterson, was an accessory product, consisting of a secondary burner tube without a primary burner tube and not positioned “below” the top of the primary burner tube, the “EMB” product cannot literally infringe any claim of the ‘159 Patent.

46. Because Peterson’s “G4” product, as made, used and sold by Peterson, consisted of a primary burner tube without a secondary burner tube, the “G4” product, as usually made, used and sold by Peterson, cannot literally infringe any claim of the ‘159 Patent.

47. Because Peterson’s “G5” product, as usually made, used and sold by Peterson, consisted of a primary burner tube without a secondary burner tube, the “G5” product, as usually made, used and sold by Peterson, cannot literally infringe any claim of the ‘159 Patent.

48. Thus, plaintiff failed to prove by a preponderance of the evidence that Peterson’s “EMB” or “G4” products, as made, used or sold by Peterson, literally infringe any claim of the ‘159 Patent.

49. No substantial evidence establishes that Peterson ever installed an “EMB” secondary burner onto a “G5” product such that the top of the secondary burner tube was “below” the top of the primary burner tube (Claim 17) or the top of the primary burner tube was at a “raised level” with regard to the top of the secondary burner tube (Claim 1).

50. No substantial evidence establishes that Peterson ever installed an “EMB” secondary burner onto a “G5” primary burner tube in a manner infringing the ‘159 Patent.

51. Thus, plaintiff failed to sustain its burden to prove by a preponderance of the evidence that Peterson’s “G5” product literally infringes any claim of the ‘159 Patent.

52. The patent law has long recognized a common law exception to infringement for experimental use. *Roche Products, Inc. v. Bolar Pharmaceuticals Co., Inc.*, 733 F.2d 858, 862 (Fed. Cir. 1984) (“by 1861, the law was ‘well-settled that an experiment with a patented article for the sole purpose of gratifying a philosophical taste, or curiosity, or for mere amusement is not an infringement of the rights of the patentee.’”); *Pitcairn v. United States*, 547 F.2d 1106 (Ct.Cl. 1976), *cert. denied*, 434 U.S. 1051 (1978) (experimental use may be a defense to infringement).

53. The single combination of a “G4” and an “EMB” which Peterson built in its laboratory for experimental purposes falls within the experimental use exception regardless of whether, as part of that experimentation, the top of the secondary burner tube was ever temporarily lowered below the top of the primary burner tube.

54. Even absent the experimental use exception, no substantial evidence establishes that the apparatus in Peterson’s laboratory was assembled such that such that the top of the secondary burner tube was “below” the top of the primary burner tube (Claim 17) or the top of the primary burner tube was at a “raised level” with regard to the top of the secondary burner tube (Claim 1).

55. Even absent the experimental use exception, plaintiff failed to prove by a preponderance of the evidence that the apparatus in Peterson's laboratory infringed the '159 Patent.

56. Peterson was not shown by a preponderance of the evidence to have made, used or sold any other products that literally infringe any claim of the '159 Patent.

INFRINGEMENT UNDER THE DOCTRINE OF EQUIVALENTS.

57. An accused device that does not literally infringe a claim of a patent may still infringe under the doctrine of equivalents if each limitation of that claim is met in the accused device either literally or equivalently. *Cybor Corp. v. FAS Technologies, Inc.*, 138 F.3d 1448, 1459 (Fed. Cir. 1998).

58. The doctrine of equivalents may not be allowed such broad play as to eliminate any individual element or limitation of a patent claim. *Warner-Jenkinson*, 520 U.S. at 29.

59. The courts have no right to enlarge a patent beyond the scope of its claims as allowed by the Patent Office. *Warner-Jenkinson*, 520 U.S. at 29; *Wilson Sporting Goods Co. v. David Geoffrey & Assoc.*, 904 F.2d 677, 684 (Fed. Cir. 1990).

60. A device or product which does not encompass both a primary burner tube and a secondary burner tube cannot be said to infringe any claim of the '159 Patent under the doctrine of equivalents because no single burner product could be the legal equivalent of the claimed primary and secondary burner tubes assembled in a specific vertical configuration which constitute a limitation of each claim of the '159 Patent.

61. A device or product which contains a primary burner tube positioned such that its top is level with or below the top of the secondary burner tube cannot be said to infringe the '159 Patent under the doctrine of equivalents because positioning the primary burner tube level with

or below the secondary burner tube cannot be the legal equivalent of positioning the primary burner tube at “a raised level” to the secondary burner tube as required by the express limitation of Claim 1 of the ‘159 Patent. *Warner-Jenkinson*, 520 U.S. at 29; *Cybor*, 138 F.3d at 1459. *See also Moba, B.V. v. Diamond Automation, Inc.*, 325 F.3d 1306, 1317 (Fed. Cir. 2003) (claim limitation which required guiding “downwardly” not infringed by accused device which guided upwardly; downwardly and upwardly were not equivalent).

62. A device or product which contains a secondary burner tube positioned with its top level with or above the top of the primary burner tube cannot be said to infringe the ‘159 Patent under the doctrine of equivalents because positioning the secondary burner tube level with or above the primary burner tube cannot be the legal equivalent of positioning the secondary burner tube “below” the primary burner tube as required by the express limitation of Claim 17 of the ‘159 Patent. *Warner-Jenkinson*, 520 U.S. at 29; *Cybor*, 138 F.3d at 1459. *See also Moba*, 325 F.3d at 1317 (claim limitation which required guiding “downwardly” not infringed by accused device which guided upwardly; downwardly and upwardly were not equivalent).

63. Because Peterson’s “G4” product, as made used and sold by Peterson, consisted of a primary burner tube without a secondary burner tube, the “G4” product cannot infringe any claim of the ‘159 Patent under the doctrine of equivalents.

64. Because Peterson’s “EMB” product, as made used and sold by Peterson, was an accessory product, consisting of a secondary burner tube without a primary burner tube, the “EMB” product cannot infringe any claim of the ‘159 Patent under the doctrine of equivalents.

65. Thus, plaintiff failed to sustain its burden to prove by a preponderance of the evidence that Peterson’s “EMB” and “G4” products infringe any claim of the ‘159 Patent under the doctrine of equivalents.

66. Because no substantial evidence showed how Peterson constructed the “G5” product when it included an “EMB” accessory or, more specifically, that the top of the primary burner tube of the “G5” was positioned at “a raised level” with respect to top of the secondary burner tube (Claim 1) or that the top of the secondary burner tube was positioned “below” the top of the “G5” primary burner tube (Claim 17), plaintiff failed to meet its burden of proving by a preponderance of the evidence that Peterson’s “G5” product infringed the ‘159 Patent under the doctrine of equivalents.

67. No other Peterson product was shown by a preponderance of the evidence to infringe any claim of the ‘159 Patent under the doctrine of equivalents.

CONTRIBUTORY INFRINGEMENT.

68. In order to establish contributory infringement, plaintiff must prove that: (i) defendant, acting without authority, made, used or sold a device or product which is a component of a machine or device which infringes a patent, (ii) defendant knew that its product was especially made or especially adapted for use in an infringement of the patent and (iii) defendant’s product was not suitable for any substantial non-infringing use. 35 U.S.C. § 271(c).

69. An essential element of a claim for contributory infringement is proof that someone assembled the accused component into a device or machine which infringed the patent. *Golden Blount, Inc. v. Robert H. Peterson Co.*, 365 F.3d at 1061 (evidence must show that “the ‘159 patent is infringed, either literally or under the doctrine of equivalents, by a customer of Peterson or other party using Peterson components”); *Carborundum Co. v. Molten Metal Equip. Innovations, Inc.*, 72 F.3d 872, 876, n. 4 (Fed. Cir. 1995).

70. Plaintiff must also show that defendant knew that the combination for which its components were especially made was both patented and infringing. *Golden Blount*, 365 F.3d at

1061; *Preemption Devices, Inc. v. Minn. Mining & Mfg., Co.*, 803 F.2d 1170, 1174 (Fed. Cir. 1986).

71. Evidence showing that an accused component “might” be used in an infringing manner is not sufficient to prove contributory infringement. *Johnson v. Atlas Mineral Products Co. of Pa.*, 140 F.2d 282, 285 (6th Cir. 1944).

72. Evidence showing that an accused component can be installed or used in a non-infringing manner is sufficient to defeat a contributory infringement claim. *Alloc, Inc. v. International Trade Commission*, 342 F.3d 1361, 1374 (Fed. Cir. 2003) (contributory infringement not proved where “the accused flooring products could be installed by methods not claimed in the ‘267 and ‘907 patents”).

73. Contributory infringement exists only where the accused component “has no use except through practice of the patented method.” *Alloc*, 342 F.3d at 1374. *Accord, Sony Corp. of America v. Universal City Studios*, 464 U.S. 417, 441 (1984).

74. Because Peterson’s “EMB” secondary burner tube accessory product was capable of being installed with its top level with or above the top of the primary burner tube, the “EMB” product was capable of being installed in a non-infringing manner.

75. Whenever Peterson’s “EMB” secondary burner tube accessory product was installed with a primary burner such that the top of the secondary burner tube was level with or above the top of the primary burner tube, the “EMB” product was being used in a non-infringing manner.

76. Because the record contains no testimony of any witness having personal knowledge of how Peterson’s dealers or customers or anyone else actually used or installed the “EMB” or any of Peterson’s products, plaintiff failed to carry its burden of proving by a

preponderance of the evidence that anyone used any Peterson product or component to infringe the '159 Patent. *Carborundum*, 72 F.3d at 876, n. 4.

77. Because Peterson's "EMB" could be installed and used as an accessory to a primary burner in a non-infringing manner, it was not manufactured by Peterson as a component especially made for use in a machine, device or combination infringing the '159 Patent.

78. Because Peterson's "EMB" could be installed and used as an accessory to a primary burner in a non-infringing manner, Peterson necessarily had no knowledge that its customers or others would use the "EMB" product to infringe the '159 Patent as opposed to using the EMB in a non-infringing installation.

79. Because Peterson's "EMB" could be installed and used as an accessory to a Peterson "G4" primary burner in a non-infringing manner, both the "G4" and the "EMB" had substantial non-infringing uses.

80. Thus, plaintiff failed to carry its burden of proving contributory infringement by a preponderance of the evidence with regard to any of Peterson's products.

INDUCED INFRINGEMENT.

81. In order to establish induced infringement, plaintiff must prove that: (i) defendant took actions that it knew or should have known would induce or cause others to infringe the patent and (ii) those actions actually did induce others to infringe the patent. 35 U.S.C. § 271(b); *Micro Chem., Inc. v. Great Plains Chem. Co.*, 194 F.3d 1250 (Fed. Cir., 1999).

82. An essential element of a claim for induced infringement is proof that someone actually infringed the patent. *Golden Blount*, 365 F.3d at 1061; *Met-Coil Sys. Corp. v. Korners Unlimited, Inc.*, 803 F.2d 684, 687 (Fed. Cir. 1986) ("There can be no inducement of infringement without direct infringement by some party.").

83. Proof of actual intent to cause the acts which constitute the infringement is a necessary prerequisite to finding inducement. *Warner Lambert Co. v. Apotex Corp.*, 316 F.3d 1348, 1363 (Fed. Cir. 2003); *Hewlett-Packard Co. v. Bausch & Lomb, Inc.*, 909 F.2d 1464, 1469 (Fed. Cir. 1990).

84. The defendant's mere knowledge of acts by others alleged to constitute infringement is not enough to prove an inducement claim. *Warner-Lambert*, 316 F.3d at 1365; *Manville Sales Corp. v. Paramount Sys., Inc.*, 917 F.2d 544, 553 (Fed. Cir. 1990).

85. Where defendant's product has substantial non-infringing uses, the intent to induce infringement cannot be inferred even when defendant has actual knowledge that some users of its product may be infringing the patent. *Warner-Lambert*, 316 F.3d at 1365; *ICN Pharmaceuticals, Inc. v. Geneva Pharmaceuticals Technology Corp.*, 272 F. Supp.2d 1028, 1048 (C.D.Cal. 2003).

86. Inducement requires proof that the defendant knowingly aided and abetted another's direct infringement of the patent. *Warner-Lambert*, 316 F.3d at 1365; *Rodime PLC v. Seagate Tech., Inc.*, 174 F.3d 1294, 1306 (Fed. Cir. 1999).

87. Because the record contains no testimony of any witness having personal knowledge of how Peterson's dealers or customers or anyone else actually used or installed the "EMB" or any of Peterson's products, plaintiff failed to prove that anyone used any Peterson product or component to infringe the '159 Patent. *Carborundum*, 72 F.3d at 876, n. 4.

88. Because Peterson's installation instructions for the "EMB" secondary burner tube accessory product do not suggest or specify that it be installed such that the top of the primary burner tube is at a "raised level" with respect to the top of the secondary burner tube (Claim 1) or that the top of the secondary burner tube be installed "below" the top of the primary burner tube

to which it is to be connected (Claim 17), these instructions do not show any specific intent to induce infringement. *Minn. Mining & Mfg. Co. v. Chemque, Inc.*, 303 F.3d 1294, 1305 (Fed. Cir. 2002) (use instructions constituted induced infringement when following them would inevitably lead to infringement); *ICN Pharmaceuticals*, 272 F. Supp.2d at 1049 (no inducement where labels did not encourage physicians to administer drug in infringing manner).

89. No evidence shows that Peterson, in any meeting with or communication to its dealers, affirmatively encouraged the installation or use of the “EMB” in a manner infringing the ‘159 Patent.

90. No evidence shows that Peterson distributed any other advertising or information or made any other communication encouraging its customers to install or use the “EMB” accessory product in a manner infringing the ‘159 Patent.

91. Because no evidence shows any direct infringement by any third party, any actual intent by Peterson to cause dealers, customers or others to infringe the ‘159 Patent or any affirmative act by Peterson to cause such infringement, plaintiff failed to sustain its burden of proving its induced infringement claim by clear and convincing evidence.

ACTUAL DAMAGES.

92. Absent proof of literal infringement by Peterson or contributory or induced infringement by others for which Peterson is shown to be legally responsible, plaintiff may not obtain an award of actual damages. 35 U.S.C., § 284 (damages awarded only to compensate for infringement).

93. Once infringement is proven, a patent plaintiff may obtain damages based on either its own lost profits or a reasonable royalty on any infringing sales.

94. No lost profits damages may be recovered absent proof of the causal relationship between the infringement and plaintiff's lost sales. *Minco, Inc. v. Combustion Engineering, Inc.*, 95 F.3d 1109, 1118 (Fed. Cir. 1996) (causation proof required); *State Indus., Inc. v. Mor-Flo Indus. Inc.*, 883 F.2d 1573, 1577 (Fed. Cir. 1989) (plaintiff must prove his manufacturing and marketing capabilities to have made the infringing sales).

95. To establish any lost profits damage award, plaintiff must prove that, but for the infringement, it would have made the infringer's sales. *Bic Leisure Prods., Inc. v. Windsurfing Int'l, Inc.*, 1 F.3d 1214, 1218 (Fed. Cir. 1993).

96. Because the record in this case shows that: (i) many of Peterson's "EMB" secondary burner products were sold to existing Peterson "G4" customers and (ii) plaintiff's secondary burner product was not suitable for use with Peterson's "G4" primary burner, Peterson's "EMB" sales to existing Peterson customers could not have caused plaintiff to lose any sales.

97. Because the record shows that Peterson's "EMB" product was not suitable for attachment to plaintiff's primary burner products, Peterson's "EMB" sales could not have caused plaintiff to lose any sales of its secondary burner product to its own existing customers.

98. Only when a customer was installing both a primary and a secondary burner could plaintiff's and Peterson's products compete for that same sale.

99. Because plaintiff offered no evidence concerning how many of Peterson's sales were to new customers who did not have a "G4" product already installed, plaintiff failed to carry its burden of showing by a preponderance of the evidence that Peterson's "EMB" sales caused plaintiff to lose any sales.

100. To prove lost profits damages, it is plaintiff's burden to show the absence of any non-infringing substitutes for the patented device. *Slimfold Mfg. Co. v. Kinkead Indus., Inc.*, 932 F.2d 1453, 1458 (Fed. Cir. 1991).

101. On this record, plaintiff failed to prove the absence of non-infringing substitutes for its ember burner accessory product.

102. Where the patentee cannot anticipate the sale of the patented component along with the components that it may be attached to, damages will only be calculated to account for lost profits related to the patented article. *Kori Corp. v. Wilco Marsh Buggies & Draglines, Inc.*, 761 F.2d 649, 656 (Fed. Cir. 1985); *see also King Instrument*, 767 F.2d at 865; *Hughes Tool Co. v. G.W. Murphy Indus., Inc.*, 491 F.2d 923, 928 (5th Cir. 1973).

103. Even if a patent plaintiff is unable to prove lost profits arising from certain infringing sales, it is entitled to damages consisting of a reasonable royalty on those sales.

104. It remains plaintiff's burden, however, to prove the amount of any reasonable royalty by substantial competent evidence. No award of damages may be based on speculation.

105. Here, plaintiff offered no testimony or other proof showing a reasonable royalty. As such, there is no basis for finding what the reasonable royalty should be on any of Peterson's sales, assuming that they were shown to be infringing.

WILLFUL INFRINGEMENT.

106. Absent proof of defendant's infringing conduct, there can be no finding of willful infringement.

107. Whether an infringer has acted willfully is a question of fact that rests upon a determination of the infringer's state of mind at the time of the infringement. *Mahurkar v. C.R.*

Bard, Inc., 79 F.3d 1572, 1579 (Fed. Cir. 1996); *Read Corp. v. Portec, Inc.* 970 F.2d 816, 827-9 (Fed. Cir. 1992) (listing nine factors).

108. An infringer has not acted willfully if, acting in good faith and upon due inquiry, he had sound reason to believe that he had the right to continue acting in the manner that was later found infringing. *SRI International, Inc., v. Advanced Technology Laboratories, Inc.*, 127 F.3d 1462, 1465 (Fed. Cir. 1997).

109. Willfulness is shown by the totality of the circumstances, including: (i) whether the infringer deliberately copied the ideas or designs of another; (ii) whether the infringer, when he knew of the other's patent protection, investigated the scope of the patent and formed a good-faith belief that it was invalid or that it was not infringed; and (iii) the infringer's behavior as a party to the litigation." *Bott v. Four Star Corp.*, 807 F.2d 1567, 1572 (Fed. Cir. 1986) *overruled on other grounds by A.C. Aukerman Co. v. R.L. Chaides Constr. Co.*, 960 F.2d 1020 (Fed. Cir. 1992).

110. Possession of a favorable opinion of counsel is not essential to avoid a willfulness determination; it is only one factor to be considered. *E.I. DuPont de Nemours & Co. v. Monsanto Corp.*, 903 F. Supp. 680 (D. Del. 1995), *aff'd*, 92 F.3d 1208 (Fed. Cir. 1996) (unpublished); *Electro Med. Sys., S.A. v. Cooper Life Sci., Inc.*, 34 F.3d 1048, 1056 (Fed. Cir. 1994); *American Original Corp. v. Jenkins Food Corp.*, 774 F.2d 459, 465-66 (Fed. Cir. 1985) (failure to obtain opinion concerning second patent did not preclude non-willfulness finding). *See also, Knorr-Bremse Systeme Fuer Nutzfahrzeuge GMBH v. Dana Corp.*, 344 F.3d 1336 (Fed. Cir. 2003) (Federal Circuit currently considering *en banc* the following question: "Should the existence of a substantial defense to infringement be sufficient to defeat liability for willful infringement even if no legal advice has been secured?" Case argued in February, 2004.).

111. Reliance upon a counsel's informal opinion can be reasonable. *Am. Med. Sys., Inc. v. Med. Eng'g Corp.*, 794 F. Supp. 1370, 1397 (E.D. Wis. 1992), *rev'd on other grounds*, 6 F.3d 1523 (Fed. Cir. 1993).

112. Because, at the time that Peterson first learned of the '159 Patent, the vast majority, if not all, of its potentially infringing products consisted of the "G4" primary burner and the "EMB" secondary burner, both of which were packaged and sold separately and were capable of being assembled and used in a non-infringing manner, it did not take a very detailed, formal or time consuming analysis for Peterson to have a reasonable basis to believe in good faith that a substantial defense to infringement existed and that it could continue to make, use and sell these separate products without itself literally infringing the '159 Patent.

113. Because they can be installed, used and configured in a non-infringing manner, Peterson's separately packaged and sold "EMB" and "G4" products cannot be said to be the result of conscious copying the invention claimed in the '159 Patent which requires that the top of the secondary burner tube be positioned below the top of the primary burner tube.

114. No substantial evidence shows that any of Peterson's products was developed by conscious copying the invention claimed in the '159 Patent.

115. Because the record contains no evidence showing that any of Peterson's customers or dealers ever assembled an "EMB" and any primary burner in an infringing manner, much less evidence than that Peterson ever knew that they had done so, Peterson cannot be said to have knowingly or willfully engaged in contributory or induced infringement. *Rite-Hite Corp. v. Kelley Company, Inc.*, 819 F.2d 1120, 1125-26 (Fed. Cir. 1987) (unknowing infringement is not willful).

116. Because the record contains no evidence showing that Peterson's "G5" products which included an "EMB" accessory product were assembled in a manner which infringed the '159 Patent, Peterson cannot be liable for willful infringement regarding these products.

117. The record contains no evidence that Peterson willfully infringed the '159 Patent in connection with any other products or activities.

ENHANCED DAMAGES.

118. Enhanced damages are in the nature of a penalty and may not be awarded as additional compensation. *Beatrice Foods Co. v. New England Printing and Lithographing Co.*, 923 F.2d 1576, 1578 (Fed. Cir. 1991); *Paper Converting Machine Co. v. Magna-Graphics Corp.*, 745 F.2d 11, 20 (Fed. Cir. 1984).

119. Enhanced damages must be premised upon willful infringement or bad faith. *Beatrice Foods*, 923 F.2d at 1579 ("enhanced damages may be awarded only as a penalty for an infringer's increased culpability"); *Yarway Corp. v. Eur-Control USA, Inc.*, 775 F.2d 268, 277 (Fed. Cir. 1985).

120. Enhanced damages are not appropriate where the infringer mounts a good faith and substantial challenge to the existence of infringement. *Paper Converting*, 745 F.2d at 20.

121. If the district court enhances damages, it must explain and articulate through findings the basis upon which it concludes that there has been willful infringement or bad faith. *Beatrice Foods*, 923 F.2d at 1578; *Reactive Metals and Alloys Corp. v. ESM, Inc.*, 769 F.2d 1578, 1582 (Fed. Cir. 1985).

122. Prejudgment interest may be applied only to the actual damages portion of any damage award and not to the punitive or enhanced portion of that award. *Beatrice Foods*, 923

F.2d at 1580; *Underwater Devices Inc. v. Morrison-Knudsen Co.*, 717 F.2d 1380, 1389 (Fed. Cir. 1983).

123. Because plaintiff has failed to prove Peterson's willful infringement or bad faith by clear and convincing evidence, there is no basis for awarding enhanced damages on the record of this case. *Beatrice Foods*, 923 F.2d at 1579; *Yarway Corp.*, 775 F.2d at 277.

EXCEPTIONAL CASE.

124. The district court may, in "exceptional" cases, award reasonable attorneys' fees to the prevailing party. 35 U.S.C. § 285.

125. The exceptional nature of the case must be shown by clear and convincing evidence. *Reactive Metals & Alloys Corp. v. ESM, Inc.*, 769 F.2d 1578, 1582-83 (Fed. Cir. 1985).

126. Among the types of conduct which can form a basis for finding a case exceptional are willful infringement, inequitable conduct before the P.T.O., misconduct during litigation, vexatious or unjustified litigation, and frivolous suit. *Standard Oil Co. v. American Cyanamid Co.*, 774 F.2d 448, 455 (Fed. Cir. 1985).

127. Even if the case is found to be "exceptional," an award of reasonable attorneys' fees is not mandatory, but remains within the sound discretion of the trial court. *Reactive Metals*, 769 F.2d at 1582.

128. Because there is no proof that Peterson committed willful infringement or engaged in any other bad faith conduct or in vexatious or unjustified litigation, there is no basis in the record for awarding attorneys' fees against Peterson.

129. Even were Peterson found to have infringed the '159 Patent in connection with the approximately 10 "G5" units that it made and sold during the relevant time period or the one

experimental apparatus in Peterson's laboratory, infringement of such a slight nature and scope would not warrant any award of attorneys' fees against Peterson.

130. Even were an award of attorneys' fees warranted against Peterson under such circumstances, that award fees would still have to be "reasonable" in amount when compared with the slight economic harm suffered by plaintiff. 35 U.S.C. § 285 (providing for an award of "reasonable attorneys fees" only).

131. Because plaintiff has failed to prove any form of infringement, Peterson must be considered the prevailing party in this litigation.

132. An award of attorneys' fees can be made against a patent plaintiff for unreasonable continuance of suit in bad faith, vexatious or unjustified litigation or for other misconduct during trial. 35 U.S.C. § 285; *Beckman Instruments, Inc. v. LKB Produkter AB*, 892 F.2d 1547, 1551 (Fed. Cir. 1989); *Hughes v. Novi American, Inc.*, 724 F.2d 122, 125 (Fed. Cir. 1984).

133. Once plaintiff learned that the vast majority of Peterson's product sales consisted of "G4" and "EMB" products which, made, used and sold separately, could not, standing alone, infringe the '159 Patent, it was incumbent on plaintiff to ascertain whether it had a reasonable basis to continue the infringement suit.

134. Because plaintiff chose to continue its infringement suit through trial and appeal without presenting any evidence whatsoever of: (i) any infringement of the '159 Patent by Peterson, (ii) any infringement of the '159 Patent by any third party which could form the basis for an indirect infringement verdict or (iii) any affirmative act by Peterson which could prove inducing infringement, this is an exceptional case by reason of plaintiff's unreasonable and vexatious continuance of suit in bad faith. *Eltech Sys. Corp. v. PPG Indus.*, 903 F.2d 805, 811

(Fed. Cir. 1990) (bad faith shown where “patentee is manifestly unreasonable in assessing infringement, while continuing to assert infringement in court.”).

As such, this Court will award Peterson its reasonable attorneys’ fees for defending the original claim through trial, prosecuting the successful appeal and participating in these proceedings on remand in an amount to be determined upon Peterson’s filing of a fee petition within 30 days.

Respectfully submitted,

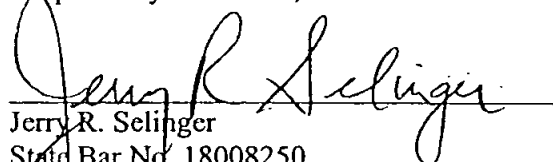

Jerry R. Selinger
State Bar No. 18008250
JENKENS & GILCHRIST, A P.C.
1445 Ross Avenue, Suite 3200
Dallas, Texas 75202
214/855-4776 (Telephone)
214/855-4300 (Facsimile)

OF COUNSEL:

Leland W. Hutchinson, Jr.
Jennifer L. Fitzgerald
David S. Becker
FREEBORN & PETERS, LLP
311 S. Wacker Dr., Suite 3000
Chicago, Illinois 60606
312/360-6000 (Telephone)
312/360-6572 (Facsimile)

CERTIFICATE OF SERVICE

This certifies that a copy of the foregoing Defendant's Proposed Findings of Fact and Conclusions of Law was served by first-class mail, postage prepaid, to counsel for Plaintiff, William D. Harris, Jr., Schultz & Associates, P.C., 5400 LBJ Freeway, One Lincoln Center, Suite 525, Dallas, Texas 75240 and Charles W. Gaines, Hitt Gaines, P.C., 2435 North Central Plaza, Suite 1300, Richardson, Texas 75080, this 10th day of June, 2004.

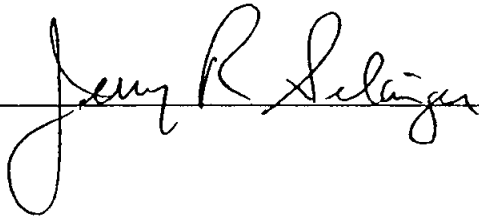

ORIGINAL

IN THE UNITED STATES DISTRICT COURT
FOR THE NORTHERN DISTRICT OF TEXAS
DALLAS DIVISION

U.S. DISTRICT COURT
NORTHERN DISTRICT OF TEXAS
DALLAS
JUN 22 2004
CLERK, U.S. DISTRICT COURT
By _____ Deputy

GORDON BLOUNT, INC.,

Plaintiff,

v.

ROBERT H. PETERSON CO.,

Defendant.

§
§
§
§
§
§
§
§

CA 3:01-CV-127-R

ORDER

This Court is of the opinion that the Defendant's Proposed Findings of Fact and Conclusions of Law (filed June 10, 2004) are correct, and they are hereby **ADOPTED** as the Findings of this Court.

IT IS SO ORDERED.

ENTERED: June 22, 2004.

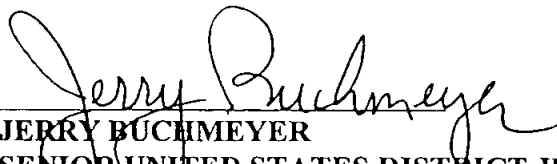
JERRY BUCHMEYER
SENIOR UNITED STATES DISTRICT JUDGE
NORTHERN DISTRICT OF TEXAS

R

IN THE UNITED STATES DISTRICT COURT
FOR THE NORTHERN DISTRICT OF TEXAS
DALLAS DIVISION

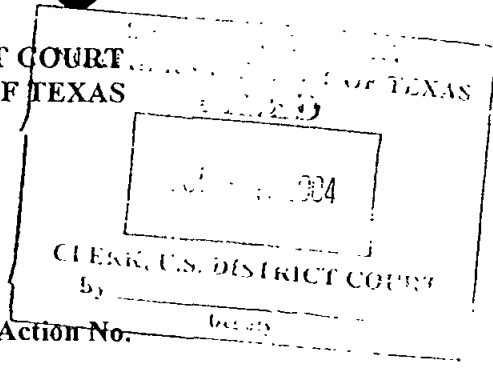

GOLDEN BLOUNT, INC.,
Plaintiff,

v.

ROBERT H. PETERSON CO.,
Defendant.

§
§
§
§
§
§
§
§

Civil Action No.

3-01CV0127-R

**PLAINTIFF, GOLDEN BLOUNT, INC.'S
REQUEST FOR RECONSIDERATION OF ADOPTION OF
DEFENDANT'S FINDINGS OF FACT AND CONCLUSIONS OF LAW,
ALTERNATIVE MOTION FOR NEW TRIAL AND REQUEST FOR ORAL HEARING**

This request is timely made inasmuch as this Court has not yet entered a final judgment in these proceedings as required by Federal Rule of Civil Procedure Rule 58, and is made under the Federal Rules of Civil Procedure, including Rules 50 and 59 FRCP.

For the record and for the purpose of Appeal, Plaintiff objects to the entire set of Findings of Fact and Conclusions of Law filed by Defendant on June 22, 2004, and adopted by this Court. Plaintiff has only specifically addressed but a small number of Defendant's Findings of Fact and Conclusions of Law in the Brief supporting this Request. Some of Defendant's Findings of Fact not specifically addressed in the Brief are set forth in the accompanying Appendix, which also include manifest errors of law and fact. For the record, Plaintiff objects to the remaining Findings of Fact and Conclusions of Law that were omitted from both the Brief and the Appendix.

For good cause shown in the accompanying Brief, Plaintiff, Golden Blount, Inc., moves this Court to reconsider its adoption of Defendant's Findings of Fact and Conclusions of Law entered June 22, 2004, and in place thereof, accept Plaintiff's Amended Findings of Fact and Conclusions of Law that are submitted concurrently herewith in a separate motion. The Findings of Fact and Conclusions of Law presented by Defendant, Robert H. Peterson Co., and adopted by this Court contain manifest errors of law and fact. Alternatively, Plaintiff moves this Court for a New Trial.

Additionally, because of the extraordinary nature of the case attributable to the Court's adoption of Defendant's Findings of Fact and Conclusions of Law, resulting in the complete reversal of this Court's previous findings, Plaintiff requests an Oral Hearing to assist this Court in resolving this Request and alternative Motion for New Trial.

Respectfully submitted,

For Plaintiff Golden Blount, Inc.

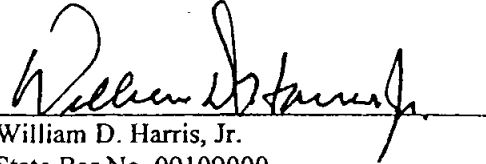

William D. Harris, Jr.

State Bar No. 09109000

SCHULTZ & ASSOCIATES, P.C.

5400 LBJ Freeway

One Lincoln Center, Suite 525

Dallas, Texas 75240

214/210-5940 (Telephone)

214/210-5941 (Facsimile)

Charles W. Gaines

State Bar No. 07570580

Greg H. Parker

State Bar No. 24011301

HITT GAINES, P.C.

2435 North Central Plaza

Suite 1300

Richardson, Texas 75080

972/480-8800 (Telephone)

972/480-8865 (Facsimile)

JT-APP 2512

RWO

IN THE UNITED STATES DISTRICT COURT
FOR THE NORTHERN DISTRICT OF TEXAS
DALLAS DIVISION

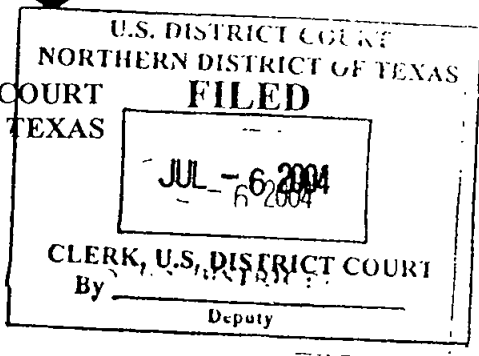

GOLDEN BLOUNT, INC.,

Plaintiff,

v.

ROBERT H. PETERSON CO.,

Defendant.

§
§
§
§
§
§
§
§

Civil Action No.

3-01CV0127-R

**PLAINTIFF, GOLDEN BLOUNT, INC.'S MOTION TO
AMEND ITS FINDINGS OF FACT AND CONCLUSIONS OF LAW**

This request is timely made inasmuch as this Court has not yet entered a final judgment in these proceedings as required by Federal Rule of Civil Procedure Rule 58.

In accordance with Federal Rules of Civil Procedure 52 (b), Plaintiff, Golden Blount, Inc., submits herewith Amended Findings of Fact and Conclusions of Law. With the exception of adding new paragraphs 126 and 133 in the Conclusion of Law section, and renumbering the paragraphs following those added paragraphs, these Amended Findings of Fact and Conclusions of Law are identical to Plaintiff's Proposed Findings of Fact and Conclusions of Law provided to this Court on June 10, 2004. Plaintiff, therefore, earnestly moves this Court to accept its Amended Findings of Fact and Conclusions of Law, submitted herewith.

Respectfully submitted,

For Plaintiff Golden Blount, Inc.

William D. Harris, Jr.
State Bar No. 09109000
SCHULTZ & ASSOCIATES, P.C.
5400 LBJ Freeway
One Lincoln Center, Suite 525
Dallas, Texas 75240
214/210-5940 (Telephone)

214/210-5941 (Facsimile)

Charles W. Gaines
State Bar No. 07570580
Greg H. Parker
State Bar No. 24011301
HITT GAINES, P.C.
2435 North Central Plaza
Suite 1300
Richardson, Texas 75080
972/480-8800 (Telephone)
972/480-8865 (Facsimile)

JT-APP 2514

IN THE UNITED STATES DISTRICT COURT
FOR THE NORTHERN DISTRICT OF TEXAS
DALLAS DIVISION

U.S. DISTRICT COURT NORTHERN DISTRICT OF TEXAS FILED MAR - 6 2004 CLERK, U.S. DISTRICT COURT By _____ Deputy

GOLDEN BLOUNT, INC.,

Plaintiff,

v.

ROBERT H. PETERSON CO.,

Defendant.

§
§
§
§
§
§
§
§

Civil Action No. _____

3-01CV0127-R

BRIEF SUPPORTING PLAINTIFF, GOLDEN BLOUNT, INC.'S, REQUEST FOR RECONSIDERATION OF ADOPTION OF DEFENDANT'S FINDINGS OF FACT AND CONCLUSIONS OF LAW, ALTERNATIVE MOTION FOR NEW TRIAL AND REQUEST FOR ORAL HEARING

Introduction

Golden Blount, Inc. ("Plaintiff"), respectfully submits that a most unusual miscarriage of justice will take place as a result of this Court's adoption of Robert H. Peterson Co.'s ("Defendant") Findings of Fact and Conclusions of Law ("Findings"). Defendant's Findings, as shown below, contain many errors. Almost two years ago this Court, after a 2 ½ day trial and its present sense observation of the witnesses, found infringement on the part of Defendant of the '159 patent, found that Defendant's acts of infringement were willful and trebled the damages, and found the case to be exceptional and awarded attorneys' fees to Plaintiff. This complete reversal, without any additional evidence or hearings of any kind, was quite unexpected. This reversal has taken place even though the Federal Circuit's decision contained no reversal, but only a remand, and indeed a partial affirmation, directing this Court to set forth more specific factual findings. In view of this complete reversal, Plaintiff earnestly petitions this Court to give careful consideration to this Brief and its request for Oral Hearing.

The Findings should be vacated or amended because they contain manifest errors of law and fact that are contrary to the great weight of the evidence. In place thereof, Plaintiff urges this Court to adopt Plaintiff's Findings of Fact and Conclusions of Law submitted concurrently herewith under a separate motion.

Errors Regarding Exceptional Case

Perhaps the most glaring and egregious error that Defendant's Findings contain are those related to attorneys' fees in favor of Defendant, which appear to be based on Plaintiff's supposed "vexatious and unjustified litigation" against Defendant. The egregious nature of these findings motivates Plaintiff to address these exceptional findings up front to demonstrate just how flagrant an error has occurred. These findings are

untenable in view of this Court's judgment of August 9, 2002, which was entirely in Plaintiff's favor, and further in view of the fact that Defendant never presented any evidence at trial to support a finding of "vexatious and unjustified litigation" on the part of Plaintiff.

Though this Court's previous judgment was vacated and remanded by the Federal Circuit, as noted above, it was partially affirmed with respect to claim construction and validity. Also, importantly, the Federal Circuit held that Peterson's charge of inequitable conduct (i.e., fraud at the Patent Office), which is possibly the most significant reason for finding a patentee liable for attorneys' fees, had been waived. The remand was for the sole purpose of directing the Court to make its findings and conclusions more specific. Therefore, the previous judgment of this Court, which was at least partially affirmed, serves as solid evidence that Plaintiff's actions were neither vexatious nor unjustified. The record as a whole before this Court contains no proof of actual wrongful intent or gross negligence on the part of Plaintiff. Case law states that a finding of exceptional circumstances on the part of the patentee, here the Plaintiff, requires proof of actual wrongful intent or gross negligence. *Advance Transformer Company v. Levinson*, 837 F.2d 1081 (Fed. Cir. 1988). Courts often find wrongful intent or gross negligence where there is inequitable conduct on the part of Plaintiff. However, not only has this Court not found inequitable conduct on the part of Plaintiff, Defendant never plead it. *Golden Blount, Inc. v. Robert H. Peterson Company*. 365 F.3d 1054, 1056 (Fed. Cir. 2004). To conclude, there is no evidence on the record that supports this finding, and therefore, it is not only clear error but is an abuse of discretion.

Many other instances of clear error exist in Defendant's Findings, which Plaintiff will now set forth in the same order as adopted by the Court. As shown below, Defendant's Findings are replete with misleading statements taken from the record, half truths and complete and utter misrepresentations that steer this Court away from the totality of the direct and circumstantial evidence, and a just result.

Errors Regarding No Evidence of Infringement:

Contrary to the implications of Defendant's Findings, to support a finding of direct infringement the record need not contain only direct evidence that Defendant or its customers assembled the EMB and G4 or G5 in an infringing manner. It is hornbook law that direct evidence of a fact is not necessary. Circumstantial evidence is not only sufficient, but may also be more certain, satisfying, and persuasive than direct evidence. *Moleculon Research Corp. v. CBS, Inc.*, 793 F.2d 1261, 1272 (Fed.Cir.1986). While direct evidence does exist, the circumstantial evidence in this case is abundant, compelling, and more than sufficient to establish infringement.

Paragraphs 31-36 of the Findings, which are more specifically set forth in the accompanying Appendix, use half truths to form the misconception that the record contains no substantial evidence that establishes infringement. For example, Paragraph 31 states that "as *usually* made.....the G5 is comprised solely of a primary

burner and related connections and does not comprise the dual burner system claimed in the '159 patent." (Emphasis added). This phrase turns completely on the word "usually," which ignores the G5's that do include the dual burner. To establish direct infringement, it matters little whether Defendant *usually* infringes, it is sufficient if it infringes at all. The evidence clearly supports the presence of G5's having the dual burner. Bortz testified that *at least 10* of the EMB's were included on the pre-assembled G5's. (Emphasis added, Tr., vol. 1, pg. 74). Additionally, Todd Corrin testified that some of the G5's were sold with an EMB on them. (Tr., vol. 2, pg. 179). Further, Defendant's own exhibit D 30, which are instructions that were provided to Defendant's customers, establish the way in which its customers oriented the tubes, which according to the Federal Circuit's claim construction, are in an infringing manner. (Tr., vol. 2, pg. 183). In discussing D 30, Todd Corrin stated:

So it shows the ember booster tube normally *would be installed* just slightly below the top of the main burner tube and *would be* about a quarter of an inch above the bottom of the main burner tube. (Emphasis added, Tr., vol. 2, pg. 173-174).

The substantial evidence in the record, both direct and circumstantial, establishes that Defendant or its customers would assemble the EMB with a G4 or G5 in a way as instructed by the manufacturer, such as according to D 30. This evidence is as sound as any other and serves as a clear foundation to find that there was direct infringement by Defendant, who assembled the accused device in its own showroom for illustrative purposes (e.g., see the testimony of Leslie Bortz and Todd Corrin), and by its customers who assembled them in their homes. In view of this testimony and the evidence in the record, Defendant's Findings contain clear error that there was no substantial evidence as to how Defendant or its customers ever assembled or installed the EMB on the G4 or G5. Thus, these findings have misled the Court and are clearly erroneous.

Errors Regarding Plaintiff's Den Exhibits:

Defendant's Findings regarding the lack of foundation of Plaintiff's exhibits is clear error, in view of Defendant's waiver of its objections. To refresh the Court's recollection, during the pretrial phase both parties raised many objections to each other's exhibits. On the first day of trial, in an effort to save this Court's time, Mr. Harris suggested that the Court let all exhibits in and that each party object as those exhibits were used. Defendant's attorney, Dean Monco, agreed to this suggestion. (Tr., vol. 1, pg. 41). However, Defendant objected only to three of them and each time was overruled by the Court.

A more salient example of clear error, however, is in paragraph 55 of the Findings where it states that Plaintiff never offered *any* foundation through *any* witness testimony to identify or authenticate Plaintiff's exhibit 4 A, which was Defendant's EMB attached to a G4. (Emphasis added). This is completely contradicted by the record. Not only did Defendant not object to Plaintiff's exhibit 4 A, its own witness, Vincent Jankowski, testified

that exhibit 4 A was Defendant's product, thereby establishing a foundation for it. (Tr., vol. 2, pg. 145, see below).

Errors Regarding Plaintiff's Witnesses:

In paragraph 134, the Findings state that Mr. Bortz testified that he did not know whether Defendant had an EMB in its product display room to show the distributors that visited Defendant's facilities, but that Defendant had one in the lab. This is yet another example of how Defendant's Findings have misled this Court. Volume 1, pages 68-70, of Mr. Bortz' deposition, which forms a part of the trial record, establishes that manufacturer's representatives (e.g., distributors) were shown a functioning EMB device in Defendant's showroom. Given Defendant's own assembly instructions set forth in D 30, which were given to its customers, (Tr., vol. 2, pg. 183), it can be concluded that the device was assembled in accordance with those installation instructions. Whether the EMB connected to the G4 was exhibited in a showroom or a lab is totally irrelevant to the question of whether Defendant assembled and demonstrated the EMB in an infringing manner. The fact remains that Defendant did so, and by gamesmanship language sought to confuse the issue to turn a clear demonstration into something it was not. This wistful use of the word "lab" is frivolous.

Errors Regarding Defendant's Witnesses:

In paragraphs 148 and 149, the Findings, which are more specifically set forth in the accompanying Appendix, state that Vincent Jankowski did not testify that Plaintiff's exhibit 4 A was an accurate depiction of Defendant's products. In support of this finding, Defendant directed the Court's attention to the entire testimony of Vincent Jankowski, thereby camouflaging the fact that Jankowski positively identified exhibit 4 A as Defendant's product, because he recognized the component parts. (Tr., vol. 2, pg. 145). This is nothing short of clear error.

In paragraphs 153 and 154, the Findings state that Todd Corrin did not testify that any of Defendant's dealers or customers ever requested a copy of D 30, nor did he *personally* send a copy of D 30 to any dealers or customers. (Emphasis added). Again, this is a misrepresentation by Defendant to this Court, because while Todd Corrin perhaps did not *personally* send a copy of D 30 to any dealers or customers, he undeniably testified that customers did receive a copy of D 30. When Todd Corrin was asked whether to his knowledge D 30 was distributed to any of Defendant's customers, his answer was "yes it has been." (Tr., vol. 2, pg. 183). Again, clear error.

Paragraph 157, which states Todd Corrin did not testify that any Peterson dealer or customer ever actually assembled the EMB and a G4 in an infringing configuration, also contains error and ignores the

circumstantial evidence that is supported by the record. Todd Corrin's own testimony regarding exhibit D 30 belies this. In responding as to how the EMB would be installed, Todd Corrin testified that:

Any time a dealer or distributor would ask for a way to install the ember booster, this (i.e., D 30) along with the instructions *would* be provided to them. So this is a drawing giving them the dimensions so they *would* know how to do that based upon our recommendation. (Emphasis added, Tr., vol. 2, pg. 174).

The unmistakable conclusion here is that the dealer or customer having asked for the instructions and having purchased the EMB and G4 *would* then use those instructions to assemble the EMB and the G4 in an infringing configuration. (Emphasis added). Given such conclusive circumstantial evidence, no direct evidence of Todd Corrin's knowledge is necessary to find that infringement actually occurred.

Errors Regarding No Evidence of Contributory Infringement:

Again, the implication of Defendant's Findings, which are more specifically set forth in the accompanying Appendix, is that the record does not contain sufficient evidence to establish contributory infringement. Contributory infringement liability arises when one "sells within the United States . . . a component of a patented machine . . . constituting a material part of the invention, knowing the same to be especially made or especially adapted for use in an infringement of such patent, and not a staple article or commodity of commerce suitable for substantially non-infringing use." 35 U.S.C. § 271(c) (2002). An appropriate infringement notice letter from the patentee to the accused infringer provides the requisite knowledge required by 35 U.S.C. § 271(c). *Aro Manufacturing Co., Inc. v. Convertible Top Replacement Co.*, 377 U.S. 476, 490 (1964).

This entire section, but more specifically paragraphs 186-193, is premised on the finding that because the EMB is capable of being assembled in a non-infringing manner, it is a staple article of commerce. In support of this, Defendant's Finding paragraph 187 only relies on PX 7, pg. 3, which are installation instructions for the EMB that say nothing about installing it in a non-infringing manner. PX 7 simply does not support the finding. Furthermore, this premise belies Defendant's own installation instructions set-forth in D 30. Again, given the fact that the record establishes that Defendant's customers, who were in possession of the EMB and G4, received the instructions as illustrated in D 30, it is reasonable to conclude that they would follow those instructions and install the components in an infringing manner. These established circumstantial facts are more than sufficient to find contributory infringement.

Regarding paragraphs 199-201, the Findings state that Leslie Bortz did not understand what a staple article of commerce was and that he did not testify that the product had no substantial non-infringing uses, and that it was especially made for use in the patented combination. This is yet another mischaracterization of the

record on the part of Defendant, because what the record actually reflects on this point is that Leslie Bortz when plainly asked the question of whether Defendant's EMB had any substantial use other than with the G4 or some related set like the G5, he answered in a word "No." (Tr., vol. 2, pg. 67). Furthermore, in his deposition testimony, Leslie Bortz testified that it was his belief that the customers wouldn't use it for anything other than with the G4 or G5. (Bortz' deposition, vol. 1, pg. 36). This evidence is in clear contradiction to what the Findings currently state, and therefore represents clear error.

Errors Regarding No Evidence of Induced Infringement

Practically the entire section of Findings, which are more specifically set forth in the accompanying Appendix, is based upon the thought that Plaintiff "offered no evidence." This simply ignores the record as a whole. For example, the Findings in paragraph 207 state that the only other Peterson literature distributed to customers (PX 6, 23) did not suggest that the top of the EMB be installed below the top of the primary burner. Again, this finding totally ignores the fact that Defendant's exhibit D 30, which was distributed to customers per the testimony of Todd Corrin, unequivocally showed that the top of the EMB burner was to be installed below the top of the primary burner. This type of mischaracterization should not be allowed to stand and should not be a basis for the Court's Findings.

Errors Regarding No Evidence of Damages

This section consists of a hodgepodge of inaccuracies of fact and law. Regarding paragraph 214, this Finding critically ignores the fact that the record establishes a two-supplier market between Plaintiff and Defendant. Mr. Blount testified that it was his belief that Plaintiff and Defendant together held approximately 95 percent or more of the market associated with Ember burners covered by the '159 patent. (Tr., vol. 1, pg. 64). Mr. Blount's testimony was un-rebutted by Defendant. In a two-supplier market it is reasonable to assume that the patent owner would have made the infringer's sales but for the infringement. *See, State Indus. v. Mor-Flo Indus.*, 883 F.2d 1573, 1578, 12 U.S.P.Q.2d 1026 (Fed. Cir. 1989).

Paragraph 215 of the Findings is an outright mischaracterization of the testimony given by Todd Corrin. The Findings state that "many EMB products were sold to people who had previously purchased the G4." However, the actual testimony states that many of the dealers actually sold the EMB to customers who had previously purchased the G4 burner, which is very different from the statement of the Findings, particularly when given the fact that Todd Corrin on cross-examination testified that "some were sold as a retrofit and some were sold along with new equipment." (Tr., vol. 2, pg. 196).

Regarding paragraphs 224-225 of the Findings, because not one of Defendant's company officials had any knowledge of its percentage of sales for entire new fireplace installations with the EMB, Plaintiff presented

evidence of a third-party witness retailer with extensive sales experience with gas fireplaces and ember burner and gas log sets, who testified that 97 ½ percent of the time that he sold an ember burner, he also sold an entire burner assembly and log set with it. (Tr., vol. 1, pg. 160). In view of Defendant's failure to contradict this evidence, even at the behest of this Court, the evidence presented by Plaintiff is sufficient upon which to establish how many sales of Defendant's EMB products were for entirely new fireplace installations, thereby making paragraphs 224-225 erroneous findings. (Tr., vol. 1, pg. 75).

The pattern is now clear . . . paragraphs 233-235 are also clearly erroneous. For example, while Mr. Blount did not testify that he prepared exhibit 18, he did testify that the sales figures, the manufacturing figures and in general all the financial figures of the company were something for which he was ultimately responsible, that they were kept in the regular course of business, and that they were accurate. (Tr., vol. 1, pg. 67-68). Again, clear error.

Further misleading statements are presented in Paragraphs 238-240. These findings indicate that no credibility can be given to Plaintiff's exhibit 18 or Mr. Blount's testimony regarding that exhibit because the exhibit fails to account for sales costs or overhead. The trial transcript is in direct contradiction to this. Mr. Blount explicitly testified that the costs set forth in exhibit 18 included materials, direct labor, indirect labor and utilities. (Tr., vol. 1, pgs. 139-40). Moreover, Mr. Blount testified that Plaintiff did have overhead costs in the calculations of exhibit 18. (Tr., vol. 1, pgs. 139-40).

The Findings stated in paragraphs 245-257, which are more specifically set forth in the accompanying Appendix, basically set forth that there are other non-infringing substitutes and that Plaintiff failed to discredit these non-infringing substitutes. These Findings are in error in labeling these alternate devices non-infringing substitutes. The "mere existence of a competing device does not make that device an acceptable substitute." *TWM Mfg. Co., Inc. v. Dura Corp.*, 789 F.2d 895, 901, 229 U.S.P.Q. 525 (Fed. Cir. 1986), *cert. denied*. A product on the market that lacks the advantages of the patented product can hardly be termed a substitute acceptable to the customer who wants those advantages. *Standard Havens Products, Inc. v. Gencor Industries, Inc.*, 953 F.2d 1360, 1373, 21 U.S.P.Q.2d 1321 (Fed. Cir. 1991), *cert. denied*. The record is, to say the least, clear that only two categories of alternative devices exist; the alternative devices are either infringing substitutes, as established by the at least five other notice of infringement letters sent out on December 10, 1999, or they were not acceptable non-infringing substitutes, as defined by case law.

Specifically, Plaintiff established at trial that Defendant's front flame director was not an acceptable substitute, and thus not a non-infringing substitute. (Tr., vol. 2, pgs. 184, 195). Defendant's own Vice President, Mr. Corrin, testified that the front flame director lacked the valve for adjusting the height of the front flame. Even more telling, Mr. Corrin testified that the front flame director was not as good as their EMB. (Tr., vol. 2, pgs. 184, 195). This testimony alone discredits the Findings of paragraph 256, which states that the front flame

director provides the same *function* and *effect* as the EMB. (Emphasis added). Also, courts have generally held that an infringer's acceptable substitute argument is of "limited influence" when it [the infringer] ignores those substitutes while selling the patented invention. (Emphasis added). *TWM*, 789 F.2d at 902. This is precisely what Defendant did. The misapplication of law, as well as numerous misstatements of fact contained within the Findings of paragraphs 245-257 provided by Defendant, leaves those Findings to be clearly erroneous.

Errors Regarding No Evidence of Willfulness and Enhanced Damages

A finding that leaves Defendant as a non-willful infringer and not subject to enhanced damages is simply not supported by the record, because the great weight of the evidence points to an opposite determination. As such, Defendant's Findings, which are more specifically set forth in the accompanying Appendix, regarding this issue represent clear error. This entire section is spun in such a way to make one believe that Defendant did its utmost to investigate and cease its infringement, and therefore the Defendant should not be subjected to enhanced damages. Based on the record, nothing could be further from the truth.

In reality, Defendant had notice of the '159 patent and its possible infringement as of December 16, 1999, (Tr., vol. 2, pg. 192), and it did little for about a year and a half other than have a couple of conversations with its ill-informed attorney, Mr. McLaughlin, all the while continuing its infringing activities. (Tr., vol. 1, pg. 181; Tr., vol. 1, pg. 200; Tr., vol. 1, pg. 202-03; Tr., vol. 2, pg. 181 and Peterson Company's Objection to Golden Blount's Motion for Updated Damages filed on September 18, 2002). The record as a whole makes clear Defendant's real intent, and it is contrary to Defendant's Findings.

The record factually establishes that Defendant saw this as an insignificant financial matter because of the cheap cost of the EMB, and therefore, was not concerned until suit was filed on January 2001. At this point, Defendant finally became concerned, not with the damages associated with its infringing activity, but with the attorney's fees that it might be required to pay as a willful infringer. (Tr., vol. 2, pg. 60-62). By Mr. Bortz' own testimony, he told Mr. McLaughlin that this was not a very meaningful case "dollar wise" but that he heard a person might have to pay attorneys' fees if he loses a patent lawsuit, and he asked Mr. McLaughlin what he should do. (Tr., vol. 2, pg. 60-62 & Dec. 19, 2001, deposition of Mr. Leslie Bortz, pg. 60). Mr. McLaughlin told him that one way that attorneys' fees could be avoided was to obtain an opinion. (Id). This testimony alone repudiates Defendant's Findings, reveals its true willfulness, and is an irrefutable indication that its Findings are erroneous.

New Trial

In the event that the Court does not grant Plaintiff's request, it moves this Court to grant a New Trial because there is an absolute absence of evidence on the record with respect to Defendant's Findings related to

its exceptional case. The only citation that Defendant's Findings give in support of an exceptional case was its own Answer. Defendant could provide no other citation on this issue. A new trial is justified where there is absolute absence of evidence to support the verdict. *Booth v. Holmes*, 399 F.2d 495 (5th Cir. Miss 1968).

Additionally, the Court should be aware that Plaintiff did not challenge Defendant's objection on the issue of conducting discovery on its customers to obtain additional evidence related to direct, contributory, and induced infringement. During the discovery phase of the trial, the Defendant, through its attorney Dean Monco, objected to and refused to provide Plaintiff with Defendant's customer list for the purpose of establishing direct, contributory and induced infringement. In exchange, Defendant agreed to provide one of Defendant's products which would accomplish Plaintiff's desires to establish the relevant heights of the burner. (Bortz' deposition, vol 1., pg. 164-169). In effect, Defendant, through its attorney Dean Monco, represented to Plaintiff that the physical device (EMB and the G4) would be adequate to replace any need to discover its customers. Now that Defendant has submitted findings that imply that Plaintiff's Exhibit 4 A fails to establish direct infringement in any way, Plaintiff should have the opportunity to conduct additional discovery and present new evidence on this matter.

Conclusion

For the reasons set forth above, Defendant's Findings, as adopted by this Court, contain numerous errors that are not supported by substantial evidence and are in clear error. Accordingly, Plaintiff urges this Court to vacate Defendant's Findings and adopt Plaintiff's Findings of Fact and Conclusions of Law submitted concurrently herewith. Alternatively, Plaintiff requests a New Trial to correct this manifest injustice.

Respectfully submitted,

For Plaintiff Golden Blount, Inc.

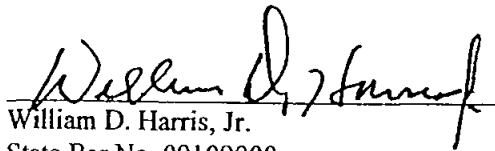

William D. Harris, Jr.
State Bar No. 09109000
SCHULTZ & ASSOCIATES, P.C.
5400 LBJ Freeway
One Lincoln Center, Suite 525
Dallas, Texas 75240
214/210-5940 (Telephone)
214/210-5941 (Facsimile)

Charles W. Gaines
State Bar No. 07570580
Greg H. Parker
State Bar No. 24011301
HITT GAINES, P.C.
2435 North Central Plaza
Suite 1300
Richardson, Texas 75080
972/480-8800 (Telephone)
972/480-8865 (Facsimile)

CERTIFICATE OF CONFERENCE

The undersigned hereby certifies that counsel for Plaintiff, Golden Blount, Inc., has in good faith conferred with Leland W. Hutchinson, Jr, counsel for Defendant, in an effort to resolve the subject of this Motion. Mr. Hutchinson, however, opposes the Motion. This Motion is therefore submitted to the Court for its determination.

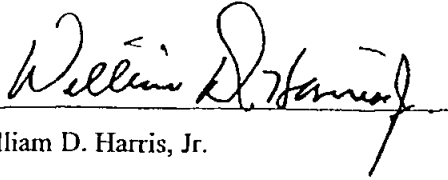
A handwritten signature in cursive script, reading "William D. Harris, Jr.", is written over a horizontal line.

William D. Harris, Jr.

CERTIFICATE OF SERVICE

I hereby certify that a true copy of the enclosed Plaintiff, Golden Blount Inc.'s, Request for Reconsideration of Adoption of Defendant's Findings of Fact and Conclusions of Law (with accompanying Appendix), Alternative Motion for New Trial and Request for Oral Hearing was served on the following counsel of record on July 6, 2004, by first class mail:

Jerry R. Selinger
Jenkins & Gilchrist
1445 Ross Avenue, Suite 3200
Dallas, Texas 75202
214/855-4500 (Telephone)
214/855-4300 (Facsimile)

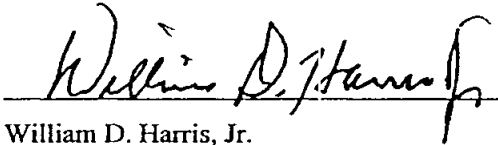
William D. Harris, Jr.

APPENDIX¹²

FINDING OF FACT—NUMBER 12	
Defendant's Findings	The "EMB" and "G4" are never assembled by Peterson. (2 Tr. 73.)
What The Record Establishes	Mr. Bortz' deposition, which forms a part of the trial record, establishes that Defendant assembled an "EMB" to a "G4" in its showroom to illustrate the device to manufacturer's representatives (e.g., distributors). (Plaintiff's Admitted Trial Exhibit No. 24, pages 68-70).

FINDING OF FACT—NUMBER 13	
Defendant's Findings	The assembly of Peterson's "G4" and "EMB" products is done in the field by the customer or an installer hired by the customer. (2 Tr. 71, 73-4.)
What The Record Establishes	The trial testimony indicates that an installer hired by the dealer would assemble the burner system. (Tr., vol. 2, pg. 75).

FINDING OF FACT—NUMBER 22	
Defendant's Findings	As usually made, used and sold by Peterson, the "G5" does not include the "EMB" accessory or any other secondary burner tube of the type claimed in the '159 Patent. (Substitute Stmt. of Stipulated Facts at ¶6; 2 Tr. 72-73, 179.)

¹In general, this is not a forum for argument, but a catalogue of the disparities between the Defendant's Findings of Fact and Conclusions of Law and the trial record.

²For ease of understanding this Appendix, the name of each witness and what party originally called the witness, is listed:

Leslie Bortz - President of Robert H. Peterson, Co. (Called by Defendant)

Tod Corrin - Vice President of Robert H. Peterson Co. (Called by Defendant)

Vincent Jankowski - Employee of Robert H. Peterson Co. (Called by Defendant)

William McLaughlin - Patent Attorney for Robert H. Peterson Co. (Called by both Parties)

Golden Blount - President & CEO of Golden Blount, Inc. (Called by Plaintiff)

Charles Hanft - Third Party Witness Retailer (Called by Plaintiff)

FINDING OF FACT—NUMBER 22

What The Record Establishes	This phrase turns completely on the word "usually," which ignores the G5's that do include the EMB. The evidence clearly supports the presence of G5's having the EMB. Mr. Bortz testified that <i>at least 10</i> of the EMB's were included on the pre-assembled G5's. (Emphasis added, Tr., vol. 1, pg. 74). Additionally, Todd Corrin testified that some of the G5's were sold with an EMB on them. (Tr., vol. 2, pg. 179).
------------------------------------	--

FINDING OF FACT—NUMBER 26

Defendant's Findings	No substantial evidence shows that, on any of the very few occasions when Peterson did assemble and sell a "G5" together with an "EMB," that the top of the "G5" primary burner tube was installed at a "raised level" with respect to the top of the "EMB" secondary burner tube.
What The Record Establishes	Defendant's EMB is intended to be attached to its G-4 series burner system or G-5 series burner system. (Joint Pretrial Order--Stipulations, pg. 6). The trial transcript further establishes that the EMB tube normally <i>would be installed</i> just slightly below the top of the main burner tube and <i>would be</i> about a quarter of an inch above the bottom of the main burner tube. (Emphasis added, Tr., vol. 2, pg. 173-174, D 30). Additionally, Todd Corrin testified that "any time a dealer or distributor would ask for a way to install the ember booster, this (i.e., D 30) along with the instructions <i>would be</i> provided to them. So this is a drawing giving them the dimensions so they <i>would</i> know how to do that based upon our recommendation." (Emphasis added, Tr., vol. 2, pg. 174). Further, when Todd Corrin was asked whether to his knowledge D 30 was distributed to any of Defendant's customers or distributors, his answer was "yes it has been." (Tr., vol. 2, pg. 183).

FINDING OF FACT—NUMBER 27

Defendant's Findings	No substantial evidence shows that, on any of the very few occasions when Peterson did assemble and sell a "G5" with together an "EMB," that the top of the "EMB" secondary burner tube was installed "below" the top of the "G5" primary burner tube.
What The Record Establishes	See supra what the record establishes in Finding of Fact Number 26.

FINDING OF FACT—NUMBER 28

Defendant's Findings	On any of the very few occasions when Peterson did assemble and sell a "G5" with an "EMB," no substantial evidence shows how Peterson assembled these products.
What The Record Establishes	See supra what the record establishes in Finding of Fact Number 26.

FINDING OF FACT—NUMBER 31	
Defendant's Findings	As usually made, used and sold by Peterson, the "G5" product is comprised solely of a primary burner and related connections and does not comprise the dual burner system claimed in the '159 Patent.
What The Record Establishes	See supra what the record establishes in Finding of Fact Number 26.

FINDING OF FACT—NUMBER 32	
Defendant's Findings	Plaintiff offered no substantial evidence proving even one infringing assembly or installation of an "EMB" with a primary burner product, either by Peterson or by anyone else.
What The Record Establishes	See supra what the record establishes in Finding of Fact Number 26.

FINDING OF FACT—NUMBER 33	
Defendant's Findings	The record contains no substantial evidence showing how Peterson ever assembled or installed any "EMB" accessory product with any primary burner.
What The Record Establishes	See supra what the record establishes in Finding of Fact Number 26.

FINDING OF FACT—NUMBER 35	
Defendant's Findings	The record contains no substantial evidence about how any Peterson dealer or customer ever assembled or installed any "EMB" accessory product.
What The Record Establishes	See supra what the record establishes in Finding of Fact Number 26.

FINDING OF FACT—NUMBER 36	
Defendant's Findings	The record contains no substantial evidence that any Peterson dealer or customer or anyone else ever assembled or installed any "EMB" accessory product with a primary burner in a manner which infringed any claim of the '159 Patent.
What The Record Establishes	See supra what the record establishes in Finding of Fact Number 26.

FINDING OF FACT—NUMBER 37	
Defendant's Findings	Prior to trial, defendant raised authenticity and other objections to each of plaintiff's demonstrative exhibits, (Robert H. Peterson Co.'s Objections to Plaintiff's Pre-Trial Disclosures at 3.)

FINDING OF FACT—NUMBER 37

What The Record Establishes	Defendant waived its objections to many of those exhibits. During the pretrial phase, both parties raised many objections to each other's exhibits. On the first day of trial, in an effort to save this Court's time, Mr. Harris suggested that the Court let all exhibits in and that each party object as those exhibits were used. Defendant's attorney, Dean Monco, agreed to this suggestion. (Tr., vol. 1, pg. 41). However, Defendant objected only to three of the demonstrative exhibits and each time was overruled by the Court.
------------------------------------	--

FINDING OF FACT—NUMBER 40

Defendant's Findings	Because Mr. Romas was never called as a witness, none of the statements which he made on the videotape were ever subject to cross examination by Peterson.
What The Record Establishes	This is irrelevant in view of the fact that the trial transcript provides that Mr. Blount, who was subject to cross examination, was present and directed the production of the videotape. (Tr. 1, vol. 1, pg. 34).

FINDING OF FACT—NUMBER 44

Defendant's Findings	Mr. Blount did not testify that the "Peterson set", which he identified on the video tape, included an "EMB" secondary burner accessory. (1 Tr. 135-145.)
What The Record Establishes	The trial transcript clearly shows that Mr. Blount identified the "Peterson set" with the ember burner on and off. (Tr., vol. 1, pgs. 44-45). Further, the video showed a side-by-side comparison of Golden Blount's CEEB set-up and Defendant's EMB set-up. (Plaintiff's Exhibit 8).

FINDING OF FACT—NUMBER 53

Defendant's Findings	Plaintiff's counsel originally referred to Plaintiff's Exhibit 4A during his opening statement without foundation, assuring the court that "we'll, connect up later." (1 Tr. 6, 38.)
What The Record Establishes	This is completely contradicted by the record. Not only did Defendant not object to Plaintiff's exhibit 4 A, its own witness, Vincent Jankowski, testified that exhibit 4 A was Defendant's product, thereby establishing a foundation for it. (Tr., vol. 2, pg. 145).

FINDING OF FACT—NUMBER 55

Defendant's Findings	Plaintiff, however, never offered any foundation through any witness testimony to identify or authenticate Plaintiff's Exhibit 4A.
What The Record Establishes	See supra what the record establishes in Finding of Fact Number 53.

FINDING OF FACT---NUMBER 56

Defendant's Findings	No witness ever affirmatively identified or authenticated Plaintiff's Exhibit 4A as consisting of a Peterson product or a combination of Peterson products.
What The Record Establishes	See supra what the record establishes in Finding of Fact Number 53.

FINDING OF FACT---NUMBER 57

Defendant's Findings	No substantial evidence shows that the burner tubes from which Plaintiffs Exhibit 4A had been assembled had been made, used or sold by Peterson.
What The Record Establishes	See supra what the record establishes in Finding of Fact Number 26.

FINDING OF FACT---NUMBER 59

Defendant's Findings	No substantial evidence establishes a chain of custody linking Plaintiff's Exhibit 4A to Peterson in anyway.
What The Record Establishes	See supra what the record establishes in Finding of Fact Number 53.

FINDING OF FACT---NUMBER 60

Defendant's Findings	Plaintiffs Exhibit 4A does not show any infringement of the '159 Patent by Peterson.
What The Record Establishes	See supra what the record establishes in Finding of Fact Numbers 26 & 53.

FINDING OF FACT---NUMBER 61

Defendant's Findings	Plaintiff's Exhibit 4A does not show any infringement of the '159 Patent by any Peterson dealer or customer.
What The Record Establishes	See supra what the record establishes in Finding of Fact Numbers 26 & 53.

FINDING OF FACT---NUMBER 78

Defendant's Findings	Neither Mr. Blount nor any other witness authenticated Plaintiff's Exhibit 9 as accurately depicting any product made, used or sold by Peterson. (1 Tr. 45-59.)
What The Record Establishes	See supra what the record establishes in Finding of Fact Number 37.

FINDING OF FACT—NUMBER 109	
Defendant's Findings	When he was shown Defendant's Exhibit 30 on direct examination during plaintiff's rebuttal case, Mr. Blount testified as follows: Q. Would you consider the primary tube to be raised relative to the secondary tube, given this picture? A. No. Q. Sir? A. The primary tube here is not really raised at all. (3 Tr. 36-7; DX 30.)
What The Record Establishes	This was later fully rebutted by Mr. Blount. (Tr., vol. 3, pgs. 37-38).

FINDING OF FACT—NUMBER 124	
Defendant's Findings	Mr. William McLaughlin, a patent attorney called by plaintiff, testified that the Peterson "EMB" did not literally infringe any claim of the '159 Patent. (1 Tr. 181.)
What The Record Establishes	The trial testimony establishes that he never considered infringement with respect to the tops of the tubes, as construed by the Federal Circuit. (Tr., vol. 2, pgs. 30-31, 34).

FINDING OF FACT—NUMBER 126	
Defendant's Findings	Mr. McLaughlin testified that the answer to interrogatory No. 1 explains reasons why Peterson's "EMB" product does not infringe the "159 Patent. (2 Tr.6; DX 61.)
What The Record Establishes	Defendant sought advice, however, it was based upon a supposition and no concrete analysis. (Tr., vol. 1, pg. 197). No competent opinion prior to the filing of the lawsuit was rendered because McLaughlin did not have the requisite materials necessary to render a competent opinion. Mr. McLaughlin did not have the accused infringing device prior to the filing of the lawsuit but only had a picture of it. (Tr., vol. 1, pg. 181). Neither did Mr. McLaughlin have the prosecution history of the '159 patent, which is an important element of any competent opinion. (Tr., vol. 1, pg. 202-03). Moreover, the record establishes that he did not know the relative positions of the tubes and did not have the prosecution history at this time. (Tr., vol. 1, pgs. 200, 202, 203).

FINDING OF FACT—NUMBER 133	
Defendant's Findings	Mr. Bortz did not testify that Peterson took any actions which encouraged, induced or caused anyone to infringe the '159 Patent. (2 Tr. 39-100.)
What The Record Establishes	Mr. Bortz testified that manufacturer's representatives (e.g., distributors) were shown a functioning EMB device in Defendant's showroom. (Plaintiff's Admitted Trial Exhibit No. 24, pages 68-70). Given Defendant's own assembly instructions set forth in D 30, which were given to its customers, (Tr., vol. 2, pg. 183), it can be concluded that the device was assembled in accordance with those installation instructions. Not surprisingly, there was no evidence to the contrary.

FINDING OF FACT---NUMBER 134	
Defendant's Findings	Mr. Bortz testified that he did not know whether Peterson had an "EMB" secondary burner assembled with a primary burner in its product display room to show the distributors who visited Peterson's facilities, but that Peterson had "one in the lab." (2 Tr. 65.)
What The Record Establishes	See supra what the record establishes in Finding of Fact Number 133.

FINDING OF FACT---NUMBER 135	
Defendant's Findings	Mr. Bortz did not testify that the top of the Peterson "EMB" secondary burner tube in the apparatus in Peterson's lab was installed "below" the top of the primary burner tube or that the top of the primary burner tube in the lab apparatus was installed at a "raised level" to the top of the secondary burner tube. (2 Tr. 65-6.)
What The Record Establishes	See supra what the record establishes in Finding of Fact Number 26.

FINDING OF FACT---NUMBER 138	
Defendant's Findings	Mr. Bortz did not testify that Peterson or any Peterson dealer or customer, ever installed an "EMB" with its top "below" the top of the customer's primary burner tube or that the top of the customer's primary burner tube was installed at a "raised level" with respect to the top of the secondary burner tube. (2 Tr. 75; 2 Tr. 39-100).
What The Record Establishes	See supra what the record establishes in Finding of Fact Number 26.

FINDING OF FACT---NUMBER 148	
Defendant's Findings	Mr. Jankowski did not testify that Plaintiffs Exhibit 4A was an accurate depiction of any product made, used or sold by Peterson. (2 Tr. 101-162.)
What The Record Establishes	See supra what the record establishes in Finding of Fact Number 53.

FINDING OF FACT---NUMBER 149	
Defendant's Findings	Mr. Jankowski did not testify that Plaintiffs Exhibit 4A was an accurate depiction of a combination of Peterson products assembled by Peterson or by any Peterson dealer or customer. (2 Tr.,101-162.)
What The Record Establishes	See supra what the record establishes in Finding of Fact Number 26.

FINDING OF FACT—NUMBER 153	
Defendant's Findings	Mr. Corrin did not testify that any Peterson dealer or customer ever actually requested a copy of Defendant's Exhibit 30. (2 Tr. 164-203.)
What The Record Establishes	When Todd Corrin was asked whether to his knowledge D 30 was distributed to any of Defendant's customers, his answer was "yes it has been." (Tr., vol. 2, pg. 183).

FINDING OF FACT—NUMBER 154	
Defendant's Findings	Mr. Corrin did not testify to having personally sent a copy of Defendant's Exhibit 30 to any Peterson dealer or customer or to anyone else. (2 Tr. 164-203.)
What The Record Establishes	This is a misrepresentation by Defendant to this Court, because while Todd Corrin perhaps did not <i>personally</i> send a copy of D 30 to any dealers or customers, he undeniably testified that customers did receive a copy of D 30. When Todd Corrin was asked whether to his knowledge D 30 was distributed to any of Defendant's customers, his answer was "yes it has been." (Tr., vol. 2, pg. 183).

FINDING OF FACT—NUMBER 155	
Defendant's Findings	Mr. Corrin did not testify that he personally observed anyone at Peterson ever sending Defendant's Exhibit 30 to any Peterson dealer or customer or to anyone else. (2 Tr. 164-203.)
What The Record Establishes	See Findings of Fact Numbers 153 and 154.

FINDING OF FACT—NUMBER 156	
Defendant's Findings	Mr. Corrin did not testify that Peterson ever assembled an "EMB" and a "G4" in the configuration shown on DX 30. (2 Tr. 164-203.)
What The Record Establishes	See Findings of Fact Numbers 26, 153 and 154.

FINDING OF FACT—NUMBER 157	
Defendant's Findings	Mr. Corrin did not testify that any Peterson dealer or customer ever actually assembled the "EMB" and a "G4" products in the configuration shown on DX 30. (2 Tr. 164-203.)
What The Record Establishes	See supra what the record establishes in Finding of Fact Number 26.

FINDING OF FACT—NUMBER 158	
Defendant's Findings	Mr. Corrin did not testify about how Peterson assembled the "EMB" product with the "G5" product. (2 Tr. 179; 2 Tr. 164-203.)

FINDING OF FACT—NUMBER 158

What The Record Establishes	See supra what the record establishes in Finding of Fact Number 26.
------------------------------------	---

FINDING OF FACT—NUMBER 159

Defendant's Findings	Mr. Corrin did not testify that when Peterson installed an "EMB" product with a "G5" product, it installed the "EMB" secondary burner tube with its top "below" the top of the "G5" primary burner tube or such that the top of the "G5" primary burner tube was at a "raised level" with respect to the top of the "EMB" secondary burner tube (2 Tr. 179; 2 Tr. 164-203.)
-----------------------------	---

What The Record Establishes	See supra what the record establishes in Finding of Fact Number 26.
------------------------------------	---

FINDING OF FACT—NUMBER 160

Defendant's Findings	Mr. Corrin did not testify that when Peterson installed an "EMB" product with a "G5" product, it installed the "EMB" secondary burner tube in a manner which infringed the '159 Patent. (2 Tr. 179; 2 Tr. 164-203.)
-----------------------------	---

What The Record Establishes	See supra what the record establishes in Finding of Fact Number 26.
------------------------------------	---

FINDING OF FACT—NUMBER 162

Defendant's Findings	Mr. Corrin testified that the "EMB" is limited in how low it can be installed relative to the "G4" primary burner tube by the "EMB's" valve touching the floor. (2 Tr. 198-201.)
-----------------------------	--

What The Record Establishes	This is irrelevant in view of the fact that D 30 shows the top of the EMB below the top of the primary burner in its preferred installation.
------------------------------------	--

FINDING OF FACT—NUMBER 163

Defendant's Findings	Mr. Corrin did not testify that the Peterson "EMB" secondary burner tube in Peterson's lab apparatus was installed with its top "below" the primary burner tube or that the top of the primary burner tube in the lab apparatus was installed at a "raised level" with respect to the top of the secondary burner tube. (2 Tr. 198-201; 2 Tr. 164-203.)
-----------------------------	---

What The Record Establishes	See supra what the record establishes in Finding of Fact Number 26.
------------------------------------	---

FINDING OF FACT—NUMBER 164

Defendant's Findings	Mr. Corrin did not testify that the Peterson "EMB" secondary burner product in Peterson's lab was installed in a manner infringing the '159 Patent. (2 Tr. 198-201, 2 Tr. 164-203.)
-----------------------------	---

FINDING OF FACT—NUMBER 164	
What The Record Establishes	See supra what the record establishes in Finding of Fact Number 26.

FINDING OF FACT—NUMBER 165	
Defendant's Findings	Mr. Corrin did not testify that Peterson or any Peterson dealer or customer, ever installed an "EMB" secondary burner product in a manner which infringed the '159 Patent. (2 Tr. 164-203.)
What The Record Establishes	See supra what the record establishes in Finding of Fact Number 26.

FINDING OF FACT—NUMBER 166	
Defendant's Findings	Mr. Corrin did not testify about the manner in which the customers, installers, dealers or anyone else installed an "EMB" secondary burner product with any primary burner. (2.Tr. 164-203.)
What The Record Establishes	See supra what the record establishes in Finding of Fact Number 26.

FINDING OF FACT—NUMBER 167	
Defendant's Findings	Mr. Corrin did not testify that Peterson took any actions which encouraged, induced or caused anyone to infringe the '159 Patent. (2 Tr. 164-203.)
What The Record Establishes	See supra what the record establishes in Finding of Fact Numbers 26 & 154.

FINDING OF FACT—NUMBER 180	
Defendant's Findings	None of Peterson's witnesses testified about any installation by Peterson or any Peterson dealer or customer or anyone else of a Peterson "EMB" product and any primary burner tube in which the top of the primary burner tube was installed at a "raised level" with respect to the top of the secondary burner tube.
What The Record Establishes	See supra what the record establishes in Finding of Fact Number 26.

FINDING OF FACT—NUMBER 181	
Defendant's Findings	None of Peterson's witnesses testified about any installation by Peterson or any Peterson dealer or customer or anyone else of a Peterson "EMB" product and any primary burner in which the top of the secondary burner tube was installed "below" than the top of the primary burner tube.
What The Record Establishes	See supra what the record establishes in Finding of Fact Number 26.

FINDING OF FACT—NUMBER 182	
Defendant's Findings	None of Peterson's witnesses testified about any installation by Peterson or any Peterson dealer or customer or anyone else of Peterson "EMB" product in a manner which infringes the '159 Patent.
What The Record Establishes	See supra what the record establishes in Finding of Fact Number 26.

FINDING OF FACT—NUMBER 183	
Defendant's Findings	None of Peterson's exhibits proved any installation by Peterson or any Peterson dealer or customer or anyone else of a Peterson "EMB" product and any primary burner in which the top of the primary burner tube was installed at a "raised level" with respect to the top of the secondary burner tube.
What The Record Establishes	See supra what the record establishes in Finding of Fact Number 26.

FINDING OF FACT—NUMBER 184	
Defendant's Findings	None of Peterson's exhibits proved any installation by Peterson or any Peterson dealer or customer or anyone else of a Peterson "EMB" product and any primary burner in which the top of the secondary burner tube was installed "below" the top of a primary burner tube.
What The Record Establishes	See supra what the record establishes in Finding of Fact Number 26.

FINDING OF FACT—NUMBER 185	
Defendant's Findings	None of Peterson's exhibits proved any installation by Peterson or any Peterson dealer or customer or anyone else of a Peterson "EMB" product in a manner which infringes the '159 Patent.
What The Record Establishes	See supra what the record establishes in Finding of Fact Number 26.

FINDING OF FACT—NUMBER 186	
Defendant's Findings	Plaintiff offered no substantial or competent evidence that any Peterson dealer, customer or anyone else ever installed or attached a Peterson "EMB" product in a manner which infringed the '159 Patent.
What The Record Establishes	See supra what the record establishes in Finding of Fact Number 26.

FINDING OF FACT—NUMBER 188	
Defendant's Findings	Any installation of an "EMB" product in which its top is level with or above the top of the primary burner does not infringe independent Claim 1 or dependent Claims 2 through 16 of the '159 Patent, all of which require a primary burner tube installed at a "raised level" with respect to the secondary burner tube.
What The Record Establishes	True, however, Defendant offered no evidence of how the EMB was installed other than D 30.

FINDING OF FACT—NUMBER 191	
Defendant's Findings	Because Peterson's "EMB" product is capable of being installed in a non-infringing manner, it has substantial non-infringing uses.
What The Record Establishes	See supra what the record establishes in Finding of Fact Number 26.

FINDING OF FACT—NUMBER 192	
Defendant's Findings	No substantial evidence shows that Peterson's "EMB" product has no substantial non-infringing uses.
What The Record Establishes	See supra what the record establishes in Finding of Fact Number 26.

FINDING OF FACT—NUMBER 193	
Defendant's Findings	Because Peterson's "EMB" product is capable of being installed in a non-infringing manner, it constitutes a "staple article of commerce" as that term is used in the patent law.
What The Record Establishes	See supra what the record establishes in Finding of Fact Number 26.

FINDING OF FACT—NUMBER 199	
Defendant's Findings	Mr. Bortz lacks sufficient personal knowledge to testify competently whether or not the Peterson "EMB" product constitutes a "staple article of commerce" as that term is used in the patent law.
What The Record Establishes	The record reflects that Leslie Bortz when plainly asked the question of whether Defendant's EMB had any substantial use other than with the G 4 or some related set like the G 5, he answered in a word "No." (Tr., vol. 2, pg. 67). Furthermore, in his deposition testimony, Leslie Bortz testified that it was his belief that the customers wouldn't use it for anything other than with the G 4 or G 5. (Plaintiff's Admitted Trial Exhibit No. 24, page 36). Also, Defendant's EMB is intended to be attached to its G-4 series burner system or G-5 series burner system. (Joint Pretrial Order—Stipulations, pg. 6).

FINDING OF FACT—NUMBER 200	
Defendant's Findings	Mr. Bortz did not testify that Peterson's "EMB" product had no substantial non-infringing uses. (2 T r. 39-100.)
What The Record Establishes	See supra what the record establishes in Finding of Fact Number 199.

FINDING OF FACT—NUMBER 201	
Defendant's Findings	No substantial evidence shows that Peterson's "EMB" product was especially made for use in the patented combination claimed in the '159 Patent.
What The Record Establishes	See supra what the record establishes in Finding of Fact Number 199.

FINDING OF FACT—NUMBER 203	
Defendant's Findings	Plaintiff offered no substantial or competent evidence hat any Peterson dealer, customer or anyone else ever installed any Peterson "EMB" product in a manner which infringed the '159 Patent.
What The Record Establishes	See supra what the record establishes in Finding of Fact Number 26.

FINDING OF FACT—NUMBER 204	
Defendant's Findings	Peterson's standard installation instructions distributed with its "EMB" product do not suggest that the "EMB" secondary burner be installed with its top "below" the top of a primary burner or that the "EMB" be installed such that the top of the primary burner remains at a "raised level" with respect to the top of the "EMB" product. (PX 7.)
What The Record Establishes	See supra what the record establishes in Finding of Fact Number 26.

FINDING OF FACT—NUMBER 205	
Defendant's Findings	Following Peterson's standard installation instructions does not inevitably lead to an installation of the "EMB" secondary burner with its top "below" the top of the primary burner. (PX 7.)
What The Record Establishes	See supra what the record establishes in Finding of Fact Number 26.

FINDING OF FACT—NUMBER 206	
Defendant's Findings	Following Peterson's standard installation instructions does not inevitably lead to an installation of the "EMB" secondary burner such that the top of the primary burner remains at a "raised level" with respect to the top of the "EMB" product. (PX 7.)
What The Record Establishes	See supra what the record establishes in Finding of Fact Number 26.

FINDING OF FACT—NUMBER 207	
Defendant's Findings	The only other Peterson literature distributed to customers offered into evidence by plaintiff also does not suggest that the top of the "EMB" secondary burner be installed "below" the top of the primary burner or that the "EMB" be installed such that the top of the primary burner remains at a "raised level" with respect to the top of the "EMB" product. (PX 6, 23.)
What The Record Establishes	See supra what the record establishes in Finding of Fact Number 26.

FINDING OF FACT—NUMBER 208	
Defendant's Findings	Plaintiff offered no other evidence of affirmative actions or communications by Peterson that induced anyone to install the "EMB" secondary burner such that the top of the primary burner remains at a "raised level" with respect to the top of the "EMB" product.
What The Record Establishes	See supra what the record establishes in Finding of Fact Number 26.

FINDING OF FACT—NUMBER 209	
Defendant's Findings	Plaintiff offered no other evidence of affirmative actions or communications by Peterson that induced anyone to install the "EMB" secondary burner with its top "below" the top of the primary burner.
What The Record Establishes	See supra what the record establishes in Finding of Fact Number 26.

FINDING OF FACT—NUMBER 210	
Defendant's Findings	Plaintiff offered no substantial evidence that Peterson knew that any of its actions or communications would cause anyone to install the "EMB" secondary burner such that the top of the primary burner remains at a "raised level" with respect to the top of the "EMB" product.
What The Record Establishes	See supra what the record establishes in Finding of Fact Number 26.

FINDING OF FACT—NUMBER 211

Defendant's Findings	Plaintiff offered no substantial evidence that Peterson knew that any of its actions or communications would cause anyone to install the "EMB" secondary burner with its top "below" the top of the primary burner.
What The Record Establishes	See supra what the record establishes in Finding of Fact Number 26.

FINDING OF FACT—NUMBER 214

Defendant's Findings	Even were plaintiff entitled to some award of damages, the evidence is insufficient to establish that, without Peterson's sales of "EMB" accessory products, plaintiff would have made any additional sales of its own products.
What The Record Establishes	The record establishes a two-supplier market between Plaintiff and Defendant. Mr. Blount testified that it was his belief that Plaintiff and Defendant together held approximately 95 percent or more of the market associated with Ember burners covered by the '159 patent. (Tr., vol. 1, pg. 64). Mr. Blount's testimony was un-rebutted by Defendant. In a two-supplier market it is reasonable to assume that the patent owner would have made the infringer's sales but for the infringement. <i>See, State Indus. v. Mor-Flo Indus.</i> , 883 F.2d 1573, 1578, 12 U.S.P.Q.2d 1026 (Fed. Cir. 1989).

FINDING OF FACT—NUMBER 215

Defendant's Findings	Many "EMB" products were sold to "people who had previously purchased G4 burner systems" to retrofit those existing Peterson systems. (2 Tr. 176.)
What The Record Establishes	The trial testimony states that many of the dealers actually sold the EMB to customers who had previously purchased the G 4 burner, which is very different from the statement of the Findings, particularly when given the fact that Todd Corrin on cross-examination testified that "some were sold as a retrofit and some were sold along with new equipment." (Tr., vol. 2, pg. 196). Nothing from any of Defendant's witnesses quantified any percentages of sale.

FINDING OF FACT—NUMBER 223

Defendant's Findings	Thus, no sale of a Peterson "EMB" accessory product could have prevented plaintiff from selling one of its own accessory products to an existing customer of plaintiff's who desired to retrofit his existing primary burner with a secondary ember burner.
What The Record Establishes	Based on the record, of the 3,723 EMB's sold by Defendant, 2 ½ percent (i.e., 94 EMB's) were sold without an associated burner assembly and log set, and the remaining 97 ½ percent (i.e., 3,629) were sold with an associated burner assembly and log set. Thus, sales of this type are accounted for and should be included in the damage calculation.

FINDING OF FACT—NUMBER 224

Defendant's Findings	Plaintiff established that 97.5% of its own sales were entire new fireplace installations (i.e., primary and secondary burners in one package). (1 Tr, 160-61.)
What The Record Establishes	See supra what the record establishes in Finding of Fact Number 223.

FINDING OF FACT—NUMBER 225

Defendant's Findings	Plaintiff failed to present any substantial evidence showing how many sales of Peterson "EMB" products were for entirely new fireplace installations.
What The Record Establishes	Not one of Defendant's company officials had any knowledge of its percentage of sales for entire new fireplace installations with the EMB. Plaintiff presented evidence of a third-party witness retailer with extensive sales experience with gas fireplaces and ember burner and gas log sets, who testified that 97 ½ percent of the time that he sold an ember burner, he also sold an entire burner assembly and log set with it. (Tr., vol. 1, pg. 160). In view of Defendant's failure to contradict this evidence, even at the behest of this Court, the evidence presented by Plaintiff is sufficient upon which to establish how many sales of Defendant's EMB products were for entirely new fireplace installations. (Tr., vol. 1, pg. 75).

FINDING OF FACT—NUMBER 226

Defendant's Findings	Plaintiff failed to present any substantial evidence showing how many additional new fireplace installations it would have made but for the sales of Peterson's "EMB" product.
What The Record Establishes	See supra what the record establishes in Finding of Fact Number 225.

FINDING OF FACT—NUMBER 233

Defendant's Findings	Mr. Blount did not testify that he prepared Plaintiff's Exhibit 18. (1 Tr. 66-7; PX 18; see also 1 Tr. 26-149, 3 Tr. 35-42.)
What The Record Establishes	Mr. Blount did not testify that he prepared exhibit 18, however, he did testify that the sales figures, the manufacturing figures and in general all the financial figures of the company were something for which he was ultimately responsible, that they were kept in the regular course of business, and that they were accurate. (Tr., vol. 1, pg. 67-68). Further, Mr. Blount explicitly testified that the costs set forth in exhibit 18 included materials, direct labor, indirect labor and utilities. (Tr., vol. 1, pgs. 139-40). Moreover, Mr. Blount testified that Plaintiff did have overhead costs in the calculations of exhibit 18. (Tr., vol. 1, pgs. 139-40).

FINDING OF FACT—NUMBER 234

Defendant's Findings	Mr. Blount did not testify was the custodian of the financial records from which Plaintiffs Exhibit 18 was prepared. (1 Tr. 66-7; PX 18; see also 1 Tr. 26-149, 3 Tr, 35-42.)
What The Record Establishes	See supra what the record establishes in Finding of Fact Number 233.

FINDING OF FACT—NUMBER 235

Defendant's Findings	Mr. Blount did not testify that, to his personal knowledge, the amounts shown on Plaintiffs Exhibit 18 accurately depicted the various costs, prices and profit margins shown on the exhibit. (1 Tr. 66-7; PX 18; see also 1 Tr. 26-149, 3 Tr, 35-42.)
What The Record Establishes	See supra what the record establishes in Finding of Fact Number 233.

FINDING OF FACT—NUMBER 237

Defendant's Findings	Plaintiff failed to present any substantial evidence that it ever sold its secondary burner accessory individually at the price represented on Plaintiff's Exhibit 18.
What The Record Establishes	See supra what the record establishes in Finding of Fact Number 233.

FINDING OF FACT—NUMBER 238

Defendant's Findings	Plaintiff failed to present any substantial evidence showing that the profit margins for either the ember burner as an accessory or for plaintiffs complete product are accurately depicted by the margins represented on Plaintiff's Exhibit 18. (1 Tr. 66-7; PX 16; PX 18.)
What The Record Establishes	See supra what the record establishes in Finding of Fact Number 233.

FINDING OF FACT—NUMBER 239

Defendant's Findings	Mr. Blount admitted that plaintiffs profit margin calculations as shown on Plaintiff's Exhibit 18 did not include sales costs or overhead, except for a small allowance for utilities. (1 Tr. 139-40.)
What The Record Establishes	See supra what the record establishes in Finding of Fact Number 233.

FINDING OF FACT—NUMBER 240

Defendant's Findings	Mr. Blount claimed that plaintiff did not have any sales or overhead costs. (1 Tr, 139-40.)
-----------------------------	---

FINDING OF FACT—NUMBER 240	
What The Record Establishes	See supra what the record establishes in Finding of Fact Number 233.

FINDING OF FACT—NUMBER 242	
Defendant's Findings	Mr. Blount submitted invoices to the Patent Office to establish commercial success (DX 3 at 000219-230.)
What The Record Establishes	The trial record is clear that the invoices submitted to the Patent Office are outside of the time frame for damages in the present suit, and therefore not relevant to damage calculations.

FINDING OF FACT—NUMBER 243	
Defendant's Findings	Those invoices show the names of salespersons, indications of freight charges and offer a 10% discount for payment within 30 days. (DX 3 at 000219-230.)
What The Record Establishes	See supra what the record establishes in Finding of Fact Number 242.

FINDING OF FACT—NUMBER 244	
Defendant's Findings	Those invoices show that plaintiff did in fact have sales and overhead costs. (DX 3 at 000219-230.)
What The Record Establishes	See supra what the record establishes in Finding of Fact Number 242.

FINDING OF FACT—NUMBER 245	
Defendant's Findings	Mr. Blount and Mr. Hanft admitted that there are at least five other products on the market that perform roughly the same function as plaintiffs device. (1 Tr. 63, 162.)
What The Record Establishes	The "[m]ere existence of a competing device does not make that device an acceptable substitute." <i>TWM Mfg. Co., Inc. v. Dura Corp.</i> , 789 F.2d 895, 901, 229 U.S.P.Q. 525 (Fed. Cir. 1986), <i>cert. denied</i> . A product on the market that lacks the advantages of the patented product can hardly be termed a substitute acceptable to the customer who wants those advantages. <i>Standard Havens Products, Inc. v. Gencor Industries, Inc.</i> , 953 F.2d 1360, 1373, 21 U.S.P.Q.2d 1321 (Fed. Cir. 1991), <i>cert. denied</i> . The record is clear that only two categories of alternative devices exist. These alternative devices are either infringing substitutes, as established by the at least five other notice of infringement letters sent out on December 10, 1999, or they were not acceptable non-infringing substitutes, as defined by case law. (Tr., vol. 1, pgs. 63-64). Specifically, Plaintiff established at trial that Defendant's front flame director was not an acceptable substitute, and thus not a non-infringing substitute, and was not as good as their EMB. (Tr., vol. 2, pgs. 184, 195).

FINDING OF FACT—NUMBER 248	
Defendant's Findings	Plaintiff failed to present any substantial evidence showing any of those substitute products to be infringing.
What The Record Establishes	See supra what the record establishes in Finding of Fact Number 245.

FINDING OF FACT—NUMBER 250	
Defendant's Findings	Each of the other products on the market that perform roughly the same function as plaintiff's device and patented invention are non-infringing substitutes.
What The Record Establishes	See supra what the record establishes in Finding of Fact Number 245.

FINDING OF FACT—NUMBER 256	
Defendant's Findings	The "Front Flame Director" provides the same function and effect as the "EMB" to produce a front flame effect. (2 Tr. 188, 195.)
What The Record Establishes	See supra what the record establishes in Finding of Fact Number 245.

FINDING OF FACT—NUMBER 257	
Defendant's Findings	The "Front Flame Director" is a non-infringing substitute for plaintiffs patented secondary burner tube.
What The Record Establishes	See supra what the record establishes in Finding of Fact Number 245.

FINDING OF FACT—NUMBER 272	
Defendant's Findings	Neither Mr. Bortz nor Mr. McLaughlin believed the December 16, 1999 letter to be a charge of infringement. (1 Tr. 170; 2 Tr. 43.)
What The Record Establishes	Defendant had notice of infringement because on December 17, 1999, Mr. Tod Corrin (Defendant's Vice President) forwarded the December 10, 1999, certified letter onto Defendant's patent counsel, Mr. William McLaughlin. Mr. Corrin wrote, in a cover letter included with the copy of the first certified letter, "[e]nclosed is a <i>patent infringement</i> letter we received from Golden Blount's Attorney." (Plaintiff's Ex. No. 17, emphasis added).

FINDING OF FACT—NUMBER 273	
Defendant's Findings	The December 16, 1999 letter was not a charge of infringement.

FINDING OF FACT—NUMBER 273

What The Record Establishes	See supra what the record establishes in Finding of Fact Number 272.
-----------------------------	--

FINDING OF FACT—NUMBER 277

Defendant's Findings	The May 3, 2000 letter contained, for the first time, a broad claim of infringement. Peterson forwarded this letter to McLaughlin. (1 Tr. 200; 2 Tr. 51; DX 19.)
What The Record Establishes	See supra what the record establishes in Finding of Fact Number 272.

FINDING OF FACT—NUMBER 283

Defendant's Findings	Mr. McLaughlin told Peterson that a file history and cited references would need to be ordered and a prior art search would have to be done. (1 Tr. 202.)
What The Record Establishes	The record establishes that this was after suit was filed, and was compelled by its concerns with paying attorneys' fees and not with the damages associated with its infringing activity. (Tr., vol. 1, pg. 202, vol. 2, pg. 60-62).

FINDING OF FACT—NUMBER 284

Defendant's Findings	Mr. McLaughlin obtained the file wrapper for the '159 Patent, (1 Tr. 202-3.)
What The Record Establishes	See supra what the record establishes in Finding of Fact Number 283.

FINDING OF FACT—NUMBER 285

Defendant's Findings	Peterson found and forwarded to Mr. McLaughlin examples of prior art in its files. (DX 22; DX 23; DX 33; DX 34; DX 35; DX 43; DX 44; DX 45; DX 46.)
What The Record Establishes	See supra what the record establishes in Finding of Fact Number 283. Nevertheless, the Court of Appeals held the '159 patent to be valid.

FINDING OF FACT—NUMBER 286

Defendant's Findings	Included in the materials sent to McLaughlin were: a diagram of an F3 depicting multiple burners and multiple valves as well as one burner higher than another, which Peterson had been selling since prior to 1977, historical advertising materials and price lists, diagrams dated July 1, 1983 showing an adjustable valve between two burners and, a diagram of the Glowing Ember Gas Log Set. (1 Tr. 204-11; DX 22; DX 23; DX 48.)
What The Record Establishes	See supra what the record establishes in Finding of Fact Number 283. Nevertheless, the Court of Appeals held the '159 patent to be valid.

FINDING OF FACT—NUMBER 287	
Defendant's Findings	Mr. McLaughlin testified he gave Peterson three specific opinions concerning the '159 Patent. These opinions were given in December 1999, February 2001 and May 2001. (1 Tr.196.)
What The Record Establishes	See supra what the record establishes in Finding of Fact Number 126.

FINDING OF FACT—NUMBER 288	
Defendant's Findings	Mr. McLaughlin opined that there were reasons to believe the Patent was invalid and reasons to believe that Peterson was not infringing (2 Tr. 63-4)
What The Record Establishes	See supra what the record establishes in Finding of Fact Number 126.

FINDING OF FACT—NUMBER 289	
Defendant's Findings	Mr. McLaughlin's December 1999 opinion was that "if we can prove that what the Peterson Company was doing with the present product, the ember flame booster for 20 or 30 years, then either they would not infringe any claim, which would be a different issue or if they infringed, that claim would be invalid." (1 Tr. 196-7)
What The Record Establishes	See supra what the record establishes in Finding of Fact Number 126.

FINDING OF FACT—NUMBER 290	
Defendant's Findings	Mr. McLaughlin's February 2001 opinion was "The Peterson ember flame booster did not literally infringe any claim of the Blount patent, and at least some of the claims were invalid at least as obvious and possibly in anticipation." (1 Tr. 181,197.)
What The Record Establishes	See supra what the record establishes in Finding of Fact Number 283.

FINDING OF FACT—NUMBER 291	
Defendant's Findings	Mr. McLaughlin's May 2001 opinion, was that Peterson did "not perform substantially the same function in substantially the same way to produce substantially the same result." (1 Tr. 183, 197.)
What The Record Establishes	See supra what the record establishes in Finding of Fact Number 283.

FINDING OF FACT----NUMBER 292	
Defendant's Findings	McLaughlin's third opinion specifically included that Claim 1 was barred under 35 U.S.C. § 103 and that claim 19 was obvious and anticipated (1 Tr. 191.)
What The Record Establishes	See supra what the record establishes in Finding of Fact Number 283.

FINDING OF FACT----NUMBER 293	
Defendant's Findings	Peterson was also told by Mr. McLaughlin that: [N]one of the claims were literally infringed. That at least with respect to claims 1 through 18 they were not infringed under the doctrine of equivalence. Claim 19 was anticipated, again subject to proving prior art, and the remaining claims of the patent were all invalid as obvious...And I also discussed some of the prior art, why they were invalid is obvious. (1 Tr. 197.)
What The Record Establishes	See supra what the record establishes in Finding of Fact Number 283.

FINDING OF FACT----NUMBER 294	
Defendant's Findings	McLaughlin put his opinion in writing to the extent that he drafted the response to Interrogatories 1 and 3, which requested an identification of claim limitations for claims 1, 17 and 19 not contained in the EMB. (2 Tr. 6; DX 61.)
What The Record Establishes	See supra what the record establishes in Finding of Fact Number 283.

FINDING OF FACT----NUMBER 295	
Defendant's Findings	Mr. McLaughlin drafted his responses based on prior art, file history and the opinion he gave to Peterson. (2 Tr. 7; DX 61.)
What The Record Establishes	See supra what the record establishes in Finding of Fact Number 283.

FINDING OF FACT----NUMBER 298	
Defendant's Findings	Peterson did obtain non-infringement opinions in this case.
What The Record Establishes	See supra what the record establishes in Finding of Fact Number 126.

FINDING OF FACT----NUMBER 299	
Defendant's Findings	Upon receipt of plaintiffs December 16, 1999 letter, Peterson immediately sought legal advice from Mr. McLaughlin.

FINDING OF FACT—NUMBER 299

What The Record Establishes	See supra what the record establishes in Finding of Fact Number 126.
------------------------------------	--

FINDING OF FACT—NUMBER 300

Defendant's Findings	In particular, Peterson was advised by its patent counsel, Mr. McLaughlin in February, 2001 that the "EMB" product did not literally infringe any claim of the '159 Patent. (1 Tr. 181, 197.)
What The Record Establishes	See supra what the record establishes in Finding of Fact Number 283.

FINDING OF FACT—NUMBER 301

Defendant's Findings	Although Mr. McLaughlin's opinion was oral, even a simple analysis quickly reveals that because Peterson was then selling its "EMB" and "G4" products in separate, unassembled packages, none of those sales could infringe the '159 Patent until someone assembled the products in an infringing configuration. (DX 31; DX 32.)
What The Record Establishes	See supra what the record establishes in Finding of Fact Number 22.

FINDING OF FACT—NUMBER 302

Defendant's Findings	Even a simple analysis also quickly showed that because Peterson's "EMB" product was capable of being installed with its top level with or above the top of a primary burner, the "EMB" product had substantial non-infringing uses.
What The Record Establishes	See supra what the record establishes in Finding of Fact Number 199. The record establishes that no one was shown or advised to the contrary.

FINDING OF FACT—NUMBER 303

Defendant's Findings	Because the length of the valve stem extending from Peterson's "EMB secondary burner physically limited the installation such that the lowest possible configuration was roughly level with top of the primary burner tube, Peterson was convinced that no infringement by its customers was occurring. (2 Tr. 198-201; 3 Tr. 36-7.)
What The Record Establishes	The trial transcript establishes that Defendant's own installation instructions, D 30, show the top of the EMB below the top of the primary burner. Moreover, the trial transcript establishes that the ember booster tube normally <i>would be installed</i> just slightly below the top of the main burner tube and <i>would be</i> about a quarter of an inch above the bottom of the main burner tube. (Emphasis added, Tr., vol. 2, pg. 173-174, D 30).

FINDING OF FACT—NUMBER 304

Defendant's Findings	Even, a simple analysis also revealed that following Peterson's standard installation instructions for the "EMB" product would not inevitably lead to an infringing installation of that product.
What The Record Establishes	See supra what the record establishes in Finding of Fact Number 303.

FINDING OF FACT—NUMBER 305

Defendant's Findings	Peterson relied upon Mr. McLaughlin's opinions. (2 Tr. 40, 50; 55.)
What The Record Establishes	See supra what the record establishes in Finding of Fact Number 126.

FINDING OF FACT—NUMBER 306

Defendant's Findings	Given the facts concerning Peterson's separate sales of its "EMB" and "G4" products and the depression limitation of the valve stem, it was reasonable for Peterson to rely on Mr. McLaughlin's non-infringement opinions.
What The Record Establishes	See supra what the record establishes in Finding of Fact Number 126.

FINDING OF FACT—NUMBER 307

Defendant's Findings	It was reasonable for Peterson and Mr. McLaughlin to conclude from these facts that Peterson could continue to manufacture and sell "G4" and "EMB" products without infringing the '159 Patent, either directly or indirectly.
What The Record Establishes	See supra what the record establishes in Finding of Fact Numbers 126 & 283.

FINDING OF FACT—NUMBER 309

Defendant's Findings	This record does not show dilatory conduct on Peterson's part.
What The Record Establishes	See supra what the record establishes in Finding of Fact Numbers 126 & 283.

FINDING OF FACT—NUMBER 311

Defendant's Findings	Nothing suggests that Peterson should have known to push McLaughlin for an earlier or more formal opinion.
-----------------------------	--

FINDING OF FACT—NUMBER 311

What The Record Establishes	The record factually establishes that Defendant saw this as an insignificant financial matter because of the cheap cost of the EMB, and therefore, was not concerned until suit was filed on January 2001. At this point, Defendant finally became concerned, not with the damages associated with its infringing activity, but with the attorneys' fees that it might be required to pay as a willful infringer. (Tr., vol. 2, pg. 60-62). By Mr. Bortz' own testimony, he told Mr. McLaughlin that this was not a very meaningful case "dollar wise" but that he heard a person might have to pay attorneys' fees if he loses a patent lawsuit, and he asked Mr. McLaughlin what he should do. (Plaintiff's Admitted Trial Exhibit No. 25, pages 60-62). Mr. McLaughlin told him that one way that attorneys' fees could be avoided was to obtain an opinion. (Tr., vol. 2, pg. 60-62 & Plaintiff's Admitted Trial Exhibit No. 25, pages 60-62).
------------------------------------	--

FINDING OF FACT—NUMBER 312

Defendant's Findings	No clear and convincing evidence shows that Peterson engaged in willful infringement by continuing to make, use and sell its separately packaged "G4" and "EMB" products after it was charged with infringing the '159 Patent.
What The Record Establishes	The record establishes that the Defendant continued to sell the EMB throughout the course of trial. (Plaintiff's Ex. No. 17 & Updated Sales Figures provided by Peterson in response to this Court's request). Given the direct, contributory and induced infringement as established in the previous findings, Defendant willfully continued to infringe the '159 patent.

FINDING OF FACT—NUMBER 313

Defendant's Findings	Because each claim of the '159 Patent requires a combination of a primary and secondary burner, it was obvious that Peterson did not literally infringe any claim the '159 Patent by continuing to sell separate primary and secondary burner component products after it was charged with infringing the '159 Patent.
What The Record Establishes	See supra what the record establishes in Finding of Fact Number 26.

FINDING OF FACT—NUMBER 314

Defendant's Findings	No clear and convincing evidence shows s that Peterson engaged in willful infringement by assembling a combination of its "G5" and "EMB products in an infringing manner after the '159 Patent issued on November 23, 1999.
What The Record Establishes	See supra what the record establishes in Finding of Fact Number 26.

FINDING OF FACT—NUMBER 315

Defendant's Findings	Because Peterson's primary and secondary burner components both have substantial non infringing uses, it was obvious that Peterson did not contributorily infringe any claim the '159 Patent by continuing to sell these components products after it was charged with infringing the '159 Patent.
What The Record Establishes	See supra what the record establishes in Finding of Fact Number 26.

FINDING OF FACT—NUMBER 316

Defendant's Findings	Because Peterson's "EMB" secondary burner product has substantial non-infringing uses, it was obvious that this product was not especially made for use in a patented combination claimed in the '159 Patent.
What The Record Establishes	See supra what the record establishes in Finding of Fact Number 26.

FINDING OF FACT—NUMBER 317

Defendant's Findings	Because none of Peterson's standard installation instructions or other literature distributed to customers regarding its "EMB" product suggest, instruct or encourage an infringing installation of the "EMB" product, it was obvious that Peterson could continue marketing that product using these materials after it was charged with infringing the '159 Patent without willfully committing induced infringement.
What The Record Establishes	See supra what the record establishes in Finding of Fact Number 26.

FINDING OF FACT—NUMBER 318

Defendant's Findings	No clear and convincing evidence shows that Peterson engaged in any form of misconduct during this litigation.
What The Record Establishes	See supra what the record establishes in Finding of Fact Number 312.

FINDING OF FACT—NUMBER 320

Defendant's Findings	Because it was or should have been obvious to plaintiff early in this litigation that Peterson did not literally infringe any claim of the '159 Patent by selling separately the "G4" and "EMB" products or by selling a "G5" product which did not include and "EMB" accessory or by selling a "G5" product with an "EMB" accessory installed level with or above the primary burner, plaintiff engaged in vexatious or unjustified litigation. (DX 65, Answer 1.)
-----------------------------	---

FINDING OF FACT—NUMBER 320

What The Record Establishes	The record as a whole before this Court contains no proof of actual wrongful intent or gross negligence on the part of Plaintiff. Defendant failed to provide any evidence on the record, other than its own answer, to support this finding.
------------------------------------	---

FINDING OF FACT—NUMBER 321

Defendant's Findings	Because plaintiff offered no evidence that any Peterson dealer or customer or any third party had ever installed an "EMB" product in a manner which infringed any claim of the '159 Patent, it was or should have been obvious to plaintiff early in this litigation that it could not prove either contributory or induced infringement.
What The Record Establishes	See supra what the record establishes in Finding of Fact Number 26.

FINDING OF FACT—NUMBER 322

Defendant's Findings	Because plaintiff obtained through discovery the literature and communications product which Peterson distributes to customers concerning the "EMB," it was or should have been obvious to plaintiff early on in this litigation that it could not prove that Peterson had taken any affirmative actions to induce others to infringe the '159 Patent.
What The Record Establishes	See supra what the record establishes in Finding of Fact Number 26.

FINDING OF FACT—NUMBER 323

Defendant's Findings	When plaintiff elected to continue its infringement claims after it knew or should have known that it could not prove either contributory or induced infringement, plaintiff engaged in vexatious or unjustified litigation.
What The Record Establishes	See supra what the record establishes in Finding of Fact Number 26.

FINDING OF FACT—NUMBER 324

Defendant's Findings	Plaintiff's continuation of vexatious or unjustified infringement claims against Peterson warrant a finding that Peterson is entitled to recover reasonable attorney's fees in an amount to be shown by a fee petition to be filed by Peterson.
What The Record Establishes	See supra what the record establishes in Finding of Fact Number 320.

R

IN THE UNITED STATES DISTRICT COURT
NORTHERN DISTRICT OF TEXAS
DALLAS DIVISION

U.S. DISTRICT COURT
NORTHERN DISTRICT OF TEXAS
FILED
JUL - 8 2004
CLERK, U.S. DISTRICT COURT
By _____
Deputy

GOLDEN BLOUNT, INC.,

Plaintiff,

VS.

ROBERT H. PETERSON, CO.,

Defendant.

§
§
§
§
§
§
§
§
§
§

CIVIL ACTION 3:01-CV-0127-R

ORDER

This Court will hear oral argument on Plaintiff, Golden Blount, Inc's MOTION TO AMEND ITS FINDINGS OF FACT AND CONCLUSIONS OF LAW (filed July 6, 2004) on August 4, 2004 at 10:00 a.m. This hearing will be held in Courtroom #1546, Dallas, Texas.

It is so ORDERED.

Entered: July 8, 2004

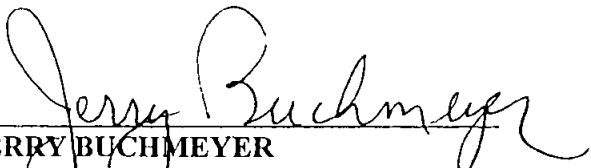

JERRY BUCHMEYER
SENIOR UNITED STATES DISTRICT COURT
NORTHERN DISTRICT OF TEXAS

Rwo

IN THE UNITED STATES DISTRICT COURT
NORTHERN DISTRICT OF TEXAS
DALLAS DIVISION

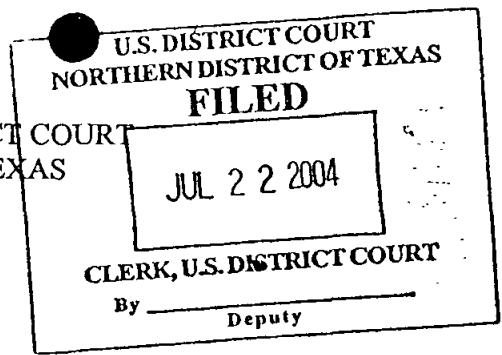

GOLDEN BLOUNT, INC.

Plaintiff,

v.

ROBERT H. PETERSON CO.

Defendant.

§
§
§
§
§
§
§
§
§

Civil Action No. 3-01CV0127-R

(JURY TRIAL DEMANDED)

**DEFENDANT ROBERT H. PETERSON'S
APPLICATION FOR ATTORNEYS' FEES**

Defendant Robert H. Peterson Co. ("Peterson"), pursuant to this Court's Findings of Fact and Conclusions of Law and 35 U.S.C. § 285, hereby applies for the award of attorneys' fees and in support thereof presents its Memorandum in Support of Defendant's Application for Attorneys' Fees; the Declarations of Leland W. Hutchinson, Jr., F. William McLaughlin and Jerry R. Selinger; and states as follows:

1. On June 22, 2004, this Court entered an order adopting Defendants' Proposed Findings of Fact and Conclusions of Law as the Court's Findings of Fact and Conclusions of Law.

2. As part of its Findings of Fact and Conclusions of Law, this Court adopted the following facts as true:

313. Because each claim of the '159 Patent requires a combination of a primary and secondary burner, it was obvious that Peterson did not literally infringe any claim the '159 Patent by continuing to sell separate primary and secondary burner component products after it was charged with infringing the '159 Patent.

315. Because Peterson's primary and secondary burner components both have substantial non-infringing uses, it was obvious that Peterson did not contributorily infringe any claim of the '159 Patent by continuing to sell these components products after it was charged with infringing the '159 Patent.

316. Because Peterson's "EMB" secondary burner product has substantial non-infringing uses, it was obvious that this product was not especially made for use in a patented combination claimed in the '159 Patent.

317. Because none of Peterson's standard installation instructions or other literature distributed to customers regarding its "EMB" product suggest, instruct or encourage an infringing installation of the "EMB" product, it was obvious that Peterson could continue marketing that product using these materials after it was charged with infringing the '159 Patent without willfully committing induced infringement.

320. Because it was or should have been obvious to plaintiff early in this litigation that Peterson did not literally infringe any claim of the '159 Patent by selling separately the "G4" and "EMB" products or by selling a "G5" product which did not include an "EMB" accessory or by selling a "G5" product with an "EMB" accessory installed level with or above the primary burner, plaintiff engaged in vexatious or unjustified litigation. (DX 65, Answer 1.)

321. Because plaintiff offered no evidence that any Peterson dealer or customer or any third party had ever installed an "EMB" product in a manner which infringed any claim of the '159 Patent, it was or should have been obvious to plaintiff early in this litigation that it could not prove either contributory or induced infringement.

322. Because plaintiff obtained through discovery the literature and communications product which Peterson distributes to customers concerning the "EMB," it was or should have been obvious to plaintiff early on in this litigation that it could not prove that Peterson had taken any affirmative actions to induce others to infringe the '159 Patent.

323. When plaintiff elected to continue its infringement claims after it knew or should have known that it could not prove either contributory or induced infringement, plaintiff engaged in vexatious or unjustified litigation.

324. Plaintiff's continuation of vexatious or unjustified infringement claims against Peterson warrant a finding that Peterson is entitled to recover reasonable attorney's fees in an amount to be shown by a fee petition to be filed by Peterson.

3. As part of its Findings of Fact and Conclusions of Law, this Court found, as a matter of law, the following:

132. An award of attorneys' fees can be made against a patent plaintiff for unreasonable continuance of suit in bad faith, vexatious or unjustified litigation or for other misconduct during trial. 35 U.S.C., § 285; *Beckman Instruments, Inc. v. LKB Produkter AB*, 892 F.2d 1547, 1551 (Fed.Cir. 1989); *Hughes v. Novi American, Inc.*, 724 F.2d 122, 125 (Fed.Cir. 1984).

133. Once plaintiff learned that the vast majority of Peterson's product sales consisted of "G4" and "EMB" products which, made, used and sold separately, could not, standing alone, infringe the '159 Patent, it was incumbent on plaintiff to ascertain whether it had a reasonable basis to continue the infringement suit.

134. Because plaintiff chose to continue its infringement suit through trial and appeal without presenting any evidence whatsoever of: (i) any infringement of the '159 Patent by Peterson, (ii) any infringement of the '159 Patent by any third party which could form the basis for an indirect infringement verdict or (iii) any affirmative act by Peterson which could prove inducing infringement, this is an exceptional case by reason of plaintiff's unreasonable and vexatious continuance of suit in bad faith. *Eltech Sys. Corp. v. PPG Indus.*, 903 F.2d 805, 811 (Fed.Cir. 1990) (bad faith shown where "patentee is manifestly unreasonable in assessing infringement, while continuing to assert infringement in court.").

135. As such, this Court will award Peterson its reasonable attorneys' fees for defending the original claim through trial, prosecuting the successful appeal and participating in these proceedings on remand in an amount to be determined upon Peterson's filing of a fee petition within 30 days.

4. Pursuant to the Court's Findings of Fact and Conclusions of Law, this Court has awarded reasonable attorneys' fees for defending the original claim through trial, prosecuting the successful appeal and participating in the proceedings on remand.

5. Peterson seeks to recover attorneys' fees and disbursement in the amount of \$586,192.62. Support for this amount is contained in the affidavits of Leland W. Hutchinson, Dean A. Monco and Jerry Selinger and Peterson Memorandum in Support of this motion which are all being simultaneously filed herewith. The affidavits provide the bases for the reasonableness, necessity and amount of the attorneys' fees sought by Peterson.

6. Peterson further requests that this Court award Peterson post judgment interest on the attorneys' fees quantified herein and all costs, beginning on June 22, 2004.

Respectfully submitted,

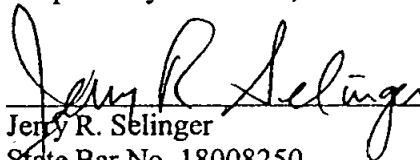

Jerry R. Selinger
State Bar No. 18008250
JENKENS & GILCHRIST, A P.C.
1445 Ross Avenue, Suite 3200
Dallas, Texas 75202
214/855-4776 (Telephone)
214/855-4300 (Facsimile)

OF COUNSEL:

Leland W. Hutchinson, Jr.
Jennifer L. Fitzgerald
David S. Becker
FREEBORN & PETERS, LLP
311 S. Wacker Dr., Suite 3000
Chicago, Illinois 60606
312/360-6000 (Telephone)
312/360-6572 (Facsimile)

CERTIFICATE OF CONFERENCE

I, David S. Becker, hereby certify that on July 22, 2004 a conference was held with counsel for the Plaintiff, to determine whether agreement could be reached with regard to the Court's award of Peterson's attorneys' fees in the amount of \$586,192.62. As a result of that conference, agreement could not be reached, accordingly, the matter is presented to the Court for determination.



David S. Becker

CERTIFICATE OF SERVICE

This certifies that a copy of the foregoing document was served by first-class mail, postage prepaid, to counsel for Plaintiff, William D. Harris, Jr., Schultz & Associates, P.C., 5400 LBJ Freeway, One Lincoln Center, Suite 525, Dallas, Texas 75240. and Charles Gaines, Hitt Gaines, P.C., 2435 North Central Plaza, Suite 1300, Richardson, Texas 75080, this 22nd day of July, 2004.

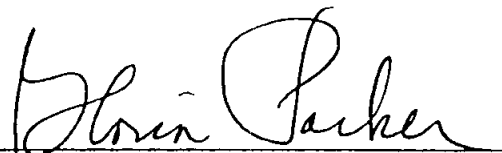

R

IN THE UNITED STATES DISTRICT COURT
NORTHERN DISTRICT OF TEXAS
DALLAS DIVISION

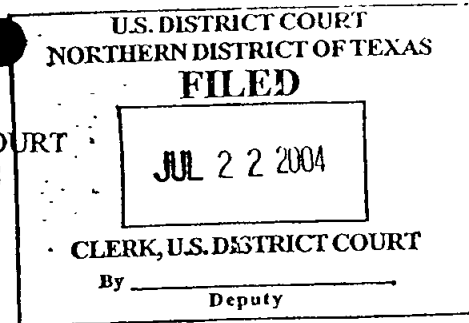

GOLDEN BLOUNT, INC.

Plaintiff,

v.

ROBERT H. PETERSON CO.

Defendant.

§
§
§
§
§
§
§
§

Civil Action No. 3-01CV0127-R

(JURY TRIAL DEMANDED)

MEMORANDUM IN SUPPORT OF DEFENDANT ROBERT H. PETERSON'S
APPLICATION FOR ATTORNEYS' FEES

INTRODUCTION

This Court should grant Robert H. Peterson Co.'s ("Peterson") attorneys' fees pursuant to 35 U.S.C. § 285 and this Court's Findings of Fact and Conclusions of Law in the amount of \$586,192.62.

On June 22, 2004, this Court entered an order adopting Defendants' Proposed Findings of Fact and Conclusions of Law as the Court's Findings of Fact and Conclusions of Law. Thus, the Court entered judgment in favor of Peterson, determining, among other things, that Peterson did not infringe the '159 patent. Findings 175-189. The Court further determined that plaintiff's continuation of its vexatious or unjustified infringement claims against Peterson warranted a finding that Peterson is entitled to recover reasonable attorney's fees in an amount to be shown by a fee petition to be filed by Peterson. Finding 324. Faced with such a situation, this Court is justified in granting Peterson its reasonable attorneys' fees.

ARGUMENT

A. PETERSON'S ATTORNEYS' FEES ARE REASONABLE AND SHOULD BE AWARDED IN FULL.

Where, as here, the Court has already concluded that a party (Peterson) can recover its attorneys' fees, all that remains for the party to do is provide the Court with some evidence to support the requested amount. *Lam v. Johns-Manville Corp.*, 718 F.2d 1056, 1068 (Fed. Cir. 1983). To demonstrate the amount of reasonable attorney's fees to award, Peterson need only present *some* evidence to support the requested amount. *Id.* This evidence may simply be the billing rate charged and the number of hours expended. *Id.* What matters is that the party carry the burden of providing the court with adequate documentation to establish that the fees incurred were reasonably expended on the litigation before the court. *Louisiana Power & Light Co. v. Kellstrom*, 50 F.3d 319, 324 (5th Cir. 1995). The documentation provided to the court must be sufficient for the court to verify that the applicant has met its burden of establishing entitlement to an award and documenting the appropriate hours expended. *Id.*

In assessing the reasonableness of attorneys' fees, Northern District of Texas courts consider the following factors outlined in *Johnson v. Georgia Highway Express, Inc.*, 488 F.2d 714, 718-19 (5th Cir. 1974): (1) the time and labor required; (2) the novelty and difficulty of the questions; (3) the skill requisite to perform the legal service properly; (4) the preclusion of other employment by the attorney due to acceptance of the case; (5) the customary fee; (6) whether the fee is fixed or contingent; (7) time limitations imposed by the client or the circumstances; (8) the amount involved and the results obtained; (9) the experience, reputation, and ability of the attorneys; (10) the "undesireability" of the case; (11) the nature and length of the professional relationship; and (12) awards in similar cases. *See In re Dahlgren International*, 811 F. Supp. 1182 (N.D. Texas 1992) (adopting *Johnson* factor test).

Taking into account all of these factors, courts typically break down attorneys' fees into two main components: (1) the number of hours spent and (2) the rate charged per hour. *Hensley v. Eckerhart*, 461 U.S. 424, 433 (1983) ("The most useful starting point for determining the amount of a reasonable fee is the number of hours reasonably expended on the litigation multiplied by a reasonable hourly rate"). There is no question that, given the complexity of the case and the skill and tenacity of counsel for Plaintiff, both the time spent and the rates charged by Peterson's attorneys to obtain judgment in Peterson's favor were reasonable.

In support of the attorneys' fees and costs that it claims, Peterson has filed declarations from attorneys for each of the firms who have worked in this case. (See Decl. of Leland W. Hutchinson, Jr.; Decl. of Dean A. Monco; Decl. of Jerry Selinger). In each declaration, the attorney has set out the roles that he and other attorneys from his firm played, as well as information regarding the attorneys' hourly rate and hours worked. Attached to each declaration are also the invoices prepared for the client in this matter, outlining the hourly time entries for each attorney involved.

With respect to the number of hours billed in preparation for and including trial, the amount of time spent was reasonable given the complexity and geographical location of evidence in this case, defendant was located in the Chicago area, while it was sued in Texas district court. To use attorneys that it had convenient proximity to, Peterson chose to work with attorneys in Chicago and employ local counsel in Texas. Initially, Wood Phillips attorneys served as lead counsel for Peterson. They handled the initial background work to understand the claim and participated in all aspects of discovery. They briefed the issue of claim construction briefing and were responsible for all depositions – both in Chicago and Dallas. Wood Phillips attorneys then

tried the case through to the court's initial ruling and participated in post-trial proceeding before this Court.

After the initial ruling was entered by this court, Peterson sought different legal support to assist in post-trial briefing and take over handling of the case beginning the appeal of the initial judgment. Freeborn & Peters was brought in for this purpose. Freeborn attorneys worked with Wood Phillips attorneys to brief post-trial issues and prepare the notice of appeal. Freeborn then took over as lead counsel. Before the Federal Circuit, Freeborn attorneys briefed and argued the case and obtained a decision vacating the initial judgment and remanding the case. Upon remand, Freeborn handled the proceedings before this Court and is currently briefing the post-trial motions.

Throughout the entirety of the case, Jenkins & Gilchrist provided guidance and support in Dallas; overseeing filings, ensuring compliance with local rules, and providing incites on local practice.

The attorneys fees expended by Peterson for this case were appropriate and duplication of efforts was avoided. At any particular stage, only one firm took the lead in the proceedings. As shown by the monthly bills submitted to Peterson, tasks were distributed according to the experience level of the attorneys, and paralegals and other staff members were utilized when appropriate. (See Hutchinson Decl. and Freeborn & Peters invoices attached thereto; Monco Decl. and Wood Phillips invoices attached thereto). It is also significant that, at trial, plaintiff and defendants had an equal number of counsel and staff involved.

Detailed descriptions of the attorneys' time are included on the monthly bills, including the specific tasks that were completed and how much time was spent on each task. While some

tasks required more than one attorney due to volume or time constraints, no services to the client were duplicated.

In light of this supporting information, all of the time entries appearing on the Peterson bills are appropriate summaries of time spent participating in discovery and other pre-trial practice, preparing for trial, trying the case, participating in the initial round of post-trial motions, appealing the initial judgment, and handling proceeding on remand.

In addition to the reasonableness of the time spent by plaintiff's counsel, their hourly rates are reasonable. While Wood Phillips originally served as lead counsel in this case, since late 2002, Freeborn & Peters has been the lead counsel in this matter. Jenkins & Gilchrist has served as local counsel throughout the entire case. Rates charged by Jenkins & Gilchrist and Wood Phillips are consistent with the usual rates charged by those firms for comparable clients. (Hutchinson Decl. ¶ 7; Monco Decl. ¶ 6; Selinger Decl. ¶ 5).

The bulk of the post-trial work was performed by Freeborn & Peters' attorneys. The Freeborn & Peters team working on the Peterson case was comprised primarily of three attorneys¹. From time to time associates would be asked to assist in preparing filings and conducting discreet legal task such as research, preparing the joint appendix on appeal, etc. The rates of all attorneys are consistent with other attorneys in the area with comparable experience. (Hutchinson Decl. ¶ 7). In fact, the hourly rates of all of the Freeborn & Peters' attorneys fall below the hourly rate of \$350 per hour that lead counsel for defendants, William Harris, charges. (Hutchinson Decl. ¶ 8). Attorneys for defendants would be hard-pressed to challenge the rates

¹ The Peterson team was comprised of Leland W. Hutchinson, Jr. (rate = originally \$395, then \$425), Jennifer Fitzgerald (rate originally \$295, then \$325) and David Becker (rate = \$195, then \$225). Additional work on the case was performed by John Stiefel (rate \$295), Jonathan Coppess (rate originally \$165, then \$185), Janel (Dohrn) Clark (rate \$175) and Tyra Holt (rate \$165). (See Hutchinson Decl. at Ex. B).

charged by Freeborn & Peters, Wood Phillips and Jenkins & Gilchrist, when their own rates are comparable to those rates charged by Peterson's counsel.

B. PETERSON CAN ALSO RECOVER FOR DISBURSEMENTS MADE DURING THE LITIGATION.

Federal courts including the Federal Circuit hold that 35 U.S.C. § 285 permits the prevailing party to also recover its out-of-pocket costs for disbursement incurred in defending or prosecuting the case. *Lam*, 718 F.2d 1056, 1068 (Fed. Cir. 1983); *see also Codex Corp v. Milgo Electronic Corp.*, 541 F.Supp. 1198 (D. Mass. 1982) (holding that compensatory purpose of [35 U.S.C. § 285] is best served if prevailing party is allowed to recover his reasonable expenses in prosecuting entire action, including . . . disbursements necessary to case . . . [and] time spend by paralegal personnel, including summer law clerks).

The out-of-pocket costs that Peterson seeks are also reasonable. An itemized chart of the out-of-pocket expenses being sought by Peterson has been prepared, and is attached hereto as Exhibit B. The chart contains the items that federal courts routinely find recoverable as part of attorneys' fees, more specifically postage, long distance calls, xeroxing, travel, air express delivery, local messenger delivery, paralegals, computerized legal research and facsimiles. The chart is broken down by item and back-up for all entries can be found in the invoices attached to the declarations of Mr. Hutchinson, Mr. Monco and Mr. Selinger which are being filed herewith.

C. PETERSON SHOULD ALSO BE AWARDED ITS POST JUDGMENT INTEREST

A district court must award post judgment interest on an unliquidated sum (i.e., the award of attorneys' fees), for an award made under 35 U.S.C. § 285. 28 U.S.C. § 1961. Interest starts to accrue on the date establishing the right to an award. *Id.*; *see also Louisiana Power & Light*, 50 F.3d at 331-32. The Court's judgment adopting defendants Finding of Fact and Conclusions of Law was issued on June 22, 2004. In those findings, the Court found that Peterson was to be

awarded its attorneys' fees. Therefore, the Court must enter an award of post judgment interest beginning on June 22, 2004, on the amount of reasonable attorneys' fees at the highest rate allowed by law.

CONCLUSION

For the reasons stated above, and in Defendant Robert H. Peterson's Application for Attorneys's Fees and the Declarations of Leland W. Hutchinson, Jr., Dean A. Monco and Jerry R. Selinger being filed herewith, Defendant Robert H. Peterson requests that this court award Peterson its attorneys' fees and disbursements in the amount of \$586,192.62 and post judgment interest at the highest rate allowed by law accruing from June 22, 2004.

Respectfully submitted,

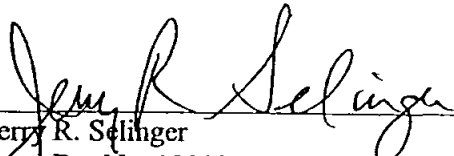

Jerry R. Selinger
State Bar No. 18008250
JENKINS & GILCHRIST, A P.C.
1445 Ross Avenue, Suite 3200
Dallas, Texas 75202
214/855-4776 (Telephone)
214/855-4300 (Facsimile)

OF COUNSEL:

Leland W. Hutchinson, Jr.
Jennifer L. Fitzgerald
David S. Becker
FREEBORN & PETERS, LLP
311 S. Wacker Dr., Suite 3000
Chicago, Illinois 60606
312/360-6000 (Telephone)
312/360-6572 (Facsimile)

CERTIFICATE OF SERVICE

This certifies that a copy of the foregoing document was served by first-class mail, postage prepaid, to counsel for Plaintiff, William D. Harris, Jr., Schultz & Associates, P.C., 5400 LBJ Freeway, One Lincoln Center, Suite 525, Dallas, Texas 75240. and Charles Gaines, Hitt Gaines, P.C., 2435 North Central Plaza, Suite 1300, Richardson, Texas 75080, this 22nd day of July, 2004.



R

IN THE UNITED STATES DISTRICT COURT
NORTHERN DISTRICT OF TEXAS
DALLAS DIVISION

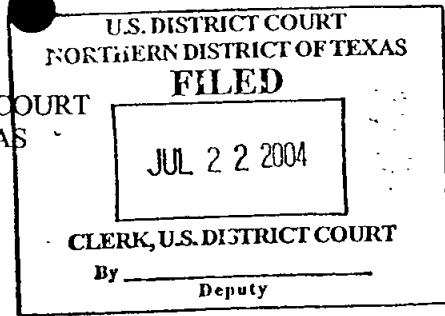

GOLDEN BLOUNT, INC.

Plaintiff,

v.

ROBERT H. PETERSON CO.

Defendant.

§
§
§
§
§
§
§
§
§

Civil Action No. 3-01CV0127-R

(JURY TRIAL DEMANDED)

**DECLARATION OF JERRY R. SELINGER IN SUPPORT OF
DEFENDANT ROBERT H. PETERSON'S APPLICATION FOR ATTORNEYS' FEES**

1. I, Jerry R. Selinger, am a shareholder with the firm of Jenkins & Gilchrist and have, since the inception of the dispute, represented Robert H. Peterson Co. in the above referenced litigation.

2. My firm served as local counsel for Robert H. Peterson and has assisted both lead counsel firms -- Wood, Phillips, Katz, Clark & Mortimer and later Freeborn & Peters -- in all aspects of this litigation.

3. Because this case is before the Northern District of Texas and the defendant is located in the Chicago area, it was necessary to have local counsel familiar in the local rules and practice before the Texas court.

4. Attached hereto as Exhibit A are true and correct copies of the Jenkins & Gilchrist invoices that have been provided to Peterson representing my firm's attorneys' fees for representation in this case.

5. As the bills indicate, I have generally handled all aspects of the local counsel role for Peterson. My billing rate is \$525 per hour. This rate is consistent with the rates charged by me to other clients comparable to Peterson.

6. In total, my firm has expended \$24,561.50 in attorneys' fees in this case. Attached as Exhibit B is a brief table summarizing this information.

7. I am familiar with the customary fees for this type of litigation charged in the Dallas area. In my opinion, the hours I have billed are reasonable in relation to the quantity and substance of the representation in this case. I further understand that my hourly rates are reasonable in relation to other similar attorneys in Dallas.

8. It is my opinion that the total value and effort by Jenkins & Gilchrist was reasonable and necessary for proper defense of this case.

9. Attached as Exhibit C is a summary table indicating the disbursements and out-of-pocket expenses incurred during the course of this case.

10. In total, my firm has disbursed \$1,573.23 for postage, long distance calls, xeroxing, travel, air express delivery, local messenger delivery, paralegals, computerized legal research and facsimiles.

11. In total Peterson is seeking \$26,134.73 in fees and disbursement for Jenkens & Gilchrist.

I declare under penalty of perjury under the laws of the United States of America that the foregoing is true and correct to the best of my knowledge and belief.

Executed July 22, 2004, at Dallas, Texas.

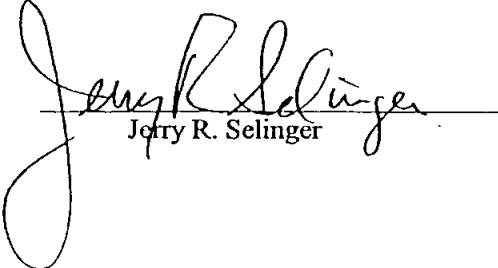
Jerry R. Selinger

Jenkins & Gilchrist
A PROFESSIONAL CORPORATION

PAYMENT REMITTANCE ADDRESS:

P.O. BOX 842552
DALLAS, TEXAS 75284-2552
TAX ID #75-2204006

OFFICE LOCATIONS:

AUSTIN, TEXAS
CHICAGO, ILLINOIS
DALLAS, TEXAS
HOUSTON, TEXAS
LOS ANGELES, CALIFORNIA
SAN ANTONIO, TEXAS
NEW YORK, NEW YORK
WASHINGTON, D.C.

April 10, 2001

ROBERT H. PETERSON COMPANY
CALIFORNIA

Invoice: 861786
Client: 52244
Matter: 00001

Regarding: GAS BURNER FOR FIREPLACE

Fees for professional services through Mar 31, 2001	\$675.00
Expense advances through Mar 31, 2001	<u>15.00</u>
Current fees and expenses through Mar 31, 2001	\$690.00
Total balance due upon receipt	<u><u>\$690.00</u></u>

A description of these charges is shown on the following pages.

A copy of this page is enclosed; please return it with your payment.

For billing inquiries, please call 214-855-4051. Tax ID# 75-2204006

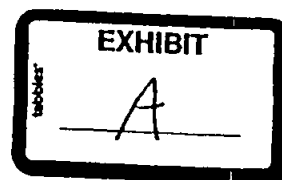

JT-APP 2572

Jenkins & Gilchrist
A PROFESSIONAL CORPORATION

April 10, 2001

Invoice: 861786
Client: 52244
Matter: 00001

Regarding: GAS BURNER FOR FIREPLACE

Description of Professional Services

03/12/01 CALL FROM BILL MC LAUGHLIN; FOLLOW-UP
CONFERENCE CALL WITH BILL MC LAUGHLIN AND JERRY
SELINGER REGARDING FILING THE ANSWER AND OTHER
RELATED ISSUES
Shareholder: Gerald Welch

03/19/01 ATTENTION TO ANSWER AND COUNTERCLAIM; FILE AND
SERVE SAME.
Shareholder: Jerry Selinger

03/21/01 REVIEW SCHEDULING ORDER; TRNASMIT SAME TO B.
MCLAUGHLIN.
Shareholder: Jerry Selinger

03/23/01 REVIEW ORDER REGARDING BUCHMEYER'S SCHEDULING
ORDER; TRANSMIT SAME TO CLIENT.
Shareholder: Jerry Selinger

Total fees: \$675.00

Jenkins & Gilchrist
A PROFESSIONAL CORPORATION

April 10, 2001

Regarding: GAS BURNER FOR FIREPLACE

Invoice: 861786
Client: 52244
Matter: 00001

Description of Expense Advances

<u>DATE</u>	<u>DESCRIPTION</u>	<u>AMOUNT</u>
03/21/01	Fax	12.00
03/24/01	Fax	3.00
Total expenses:		<hr/> \$15.00

Jenkins & Gilchrist
A PROFESSIONAL CORPORATION

PAYMENT REMITTANCE ADDRESS:

P.O. BOX 842552
DALLAS, TEXAS 75284-2552
TAX ID #75-2204004

OFFICE LOCATIONS:

AUSTIN, TEXAS
CHICAGO, ILLINOIS
DALLAS, TEXAS
HOUSTON, TEXAS
LOS ANGELES, CALIFORNIA
SAN ANTONIO, TEXAS
NEW YORK, NEW YORK
WASHINGTON, D.C.

REMITTANCE ADVICE

April 10, 2001

ROBERT H. PETERSON COMPANY
CALIFORNIA

Invoice: 861786
Client: 52244
Matter: 00001

Regarding: GAS BURNER FOR FIREPLACE

Fees for professional services through Mar 31, 2001	\$675.00
Expense advances through Mar 31, 2001	<u>15.00</u>
Current fees and expenses through Mar 31, 2001	\$690.00
Total balance due upon receipt	<u>\$690.00</u>

Payment of this invoice may be made by wire transfer:

BANK OF AMERICA, N.A.
ABA# 111000025
Jenkins & Gilchrist, A Professional Corporation
1445 Ross Avenue, Suite 3200, Dallas, Texas 75202-2799
Account #004772063741
Ref: Client/Matter - Name & Number

JT-APP 2575

Jenkins & Gilchrist
A PROFESSIONAL CORPORATION

PAYMENT REMITTANCE ADDRESS:

P.O. BOX 841552
DALLAS, TEXAS 75284-2552
TAX ID #75-2204006

OFFICE LOCATIONS:

AUSTIN, TEXAS
CHICAGO, ILLINOIS
DALLAS, TEXAS
HOUSTON, TEXAS
LOS ANGELES, CALIFORNIA
SAN ANTONIO, TEXAS
NEW YORK, NEW YORK
WASHINGTON, D.C.

June 18, 2001

ROBERT H. PETERSON COMPANY
CALIFORNIA

Invoice: 885399
Client: 52244
Matter: 00001

Regarding: GAS BURNER FOR FIREPLACE

Fees for professional services through May 31, 2001	\$1,530.00
Expense advances through May 31, 2001	<u>51.26</u>
Current fees and expenses through May 31, 2001	\$1,581.26
Total balance due upon receipt	<u>\$1,581.26</u>

A description of these charges is shown on the following pages.

A copy of this page is enclosed; please return it with your payment.

For billing inquiries, please call 214-855-4051. Tax ID# 75-2204006

JT-APP 2576

Jenkins & Gilchrist

A PROFESSIONAL CORPORATION

June 18, 2001

Regarding: GAS BURNER FOR FIREPLACE

Invoice: 885399

Client: 52244

Matter: 00001

Description of Professional Services

- 05/09/01 RECEIVE DISCOVERY FROM B. MCLAUGHLIN;
TELEPHONE CONFERENCE WITH B. MCLAUGHLIN
REGARDING DEADLINE TO SERVE SAME.
Shareholder: Jerry Selinger
- 05/17/01 TELEPHONE CONFERENCE WITH B. MCLAUGHLIN
REGARDING DRAFT DISCOVERY AND JOINT STATUS
REPORT; REVIEW DRAFT OF SAME PROVIDED BY
OPPOSING COUNSEL.
Shareholder: Jerry Selinger
- 05/18/01 ATTENTION TO JOINT STATUS REPORT; TELEPHONE
CONFERENCE WITH CLIENT REGARDING SAME;
ATTENTION TO FILING SAME.
Shareholder: Jerry Selinger
- 05/21/01 ATTENTION TO DISCOVERY RESPONSES; SERVE SAME;
TELEPHONE CONFERENCE WITH BILL MCLAUGHLIN
REGARDING DISCOVERY TO PLAINTIFF; REVISE AND
SERVE SAME; ATTENTION TO DEFENDANT'S DISCOVERY;
TELEPHONE CONFERENCE WITH B. MCLAUGHLIN
REGARDING SAME
Shareholder: Jerry Selinger
- 05/22/01 CONTINUED ATTENTION TO DISCOVERY TO PLAINTIFF.
Shareholder: Jerry Selinger
- 05/24/01 CONTINUE ATTENTION TO DISCOVERY TO DEFENDANTS;
TRANSMIT SAME TO MR. MCLAUGHLIN
(ELECTRONICALLY) FOR REVIEW; SERVE SAME.
Shareholder: Jerry Selinger

Total fees:

\$1,530.00

Jenkins & Gilchrist
A PROFESSIONAL CORPORATION

June 18, 2001

Invoice: 885399

Client: 52244

Matter: 00001

Regarding: GAS BURNER FOR FIREPLACE

Description of Expense Advances

<u>DATE</u>	<u>DESCRIPTION</u>	<u>AMOUNT</u>
03/19/01	Document Express Courier Service	18.34
04/17/01	Fax	12.00
04/18/01	Fax	1.00
05/21/01	Copies	6.40
05/21/01	Postage	2.36
05/24/01	Copies	8.80
05/24/01	Postage	2.36
Total expenses:		\$51.26

Jenkins & Gilchrist
A PROFESSIONAL CORPORATION

PAYMENT REMITTANCE ADDRESS:

P.O. BOX 842552
DALLAS, TEXAS 75284-2552
TAX ID #75-2204006

OFFICE LOCATIONS:

AUSTIN, TEXAS
CHICAGO, ILLINOIS
DALLAS, TEXAS
HOUSTON, TEXAS
LOS ANGELES, CALIFORNIA
SAN ANTONIO, TEXAS
NEW YORK, NEW YORK
WASHINGTON, D.C.

REMITTANCE ADVICE

June 18, 2001

ROBERT H. PETERSON COMPANY
CALIFORNIA

Invoice: 885399
Client: 52244
Matter: 00001

Regarding: GAS BURNER FOR FIREPLACE

Fees for professional services through May 31, 2001	\$1,530.00
Expense advances through May 31, 2001	<u>51.26</u>
Current fees and expenses through May 31, 2001	\$1,581.26
Total balance due upon receipt	<u>\$1,581.26</u>

Payment of this invoice may be made by wire transfer:

BANK OF AMERICA, N.A.
ABA# 111000025
Jenkins & Gilchrist, A Professional Corporation
1445 Ross Avenue, Suite 3200, Dallas, Texas 75202-2799
Account #004772063741
Ref: Client/Matter - Name & Number

JT-APP 2579

Jenkins & Gilchrist
A PROFESSIONAL CORPORATION

PAYMENT REMITTANCE ADDRESS:

P.O. BOX 941552
DALLAS, TEXAS 75284-2552
TAX ID #75-2204006

OFFICE LOCATIONS:

AUSTIN, TEXAS
CHICAGO, ILLINOIS
DALLAS, TEXAS
HOUSTON, TEXAS
LOS ANGELES, CALIFORNIA
SAN ANTONIO, TEXAS
NEW YORK, NEW YORK
WASHINGTON, D.C.

July 23, 2001

ROBERT H. PETERSON COMPANY
CALIFORNIA

Invoice: 895733
Client: 52244
Matter: 00001

Regarding: GAS BURNER FOR FIREPLACE

Fees for professional services through Jun 30, 2001	\$180.00
Expense advances through Jun 30, 2001	<u>.00</u>
Current fees and expenses through Jun 30, 2001	\$180.00
Total balance due upon receipt	<u><u>\$180.00</u></u>

A description of these charges is shown on the following pages.

A copy of this page is enclosed; please return it with your payment.

For billing inquiries, please call 214-855-4051. Tax ID# 75-2204006

JT-APP 2580

Jenkins & Gilchrist
A PROFESSIONAL CORPORATION

July 23, 2001

Regarding: GAS BURNER FOR FIREPLACE

Invoice: 895733
Client: 52244
Matter: 00001

Description of Professional Services

06/05/01 ATTENTION TO PROPOSED PROTECTIVE ORDER.
Shareholder: Jerry Selinger

06/20/01 RECEIVE PROTECTIVE ORDER ENTERED BY COURT;
TRANSMIT SAME TO CLIENT.
Shareholder: Jerry Selinger

Total fees: \$180.00

Jenkins & Gilchrist
A PROFESSIONAL CORPORATION

PAYMENT REMITTANCE ADDRESS:

P.O. BOX 842552
DALLAS, TEXAS 75284-2552
TAX ID #75-2204004

OFFICE LOCATIONS:

AUSTIN, TEXAS
CHICAGO, ILLINOIS
DALLAS, TEXAS
HOUSTON, TEXAS
LOS ANGELES, CALIFORNIA
SAN ANTONIO, TEXAS
NEW YORK, NEW YORK
WASHINGTON, D.C.

REMITTANCE ADVICE

July 23, 2001

ROBERT H. PETERSON COMPANY
CALIFORNIA

Invoice: 895733
Client: 52244
Matter: 00001

Regarding: GAS BURNER FOR FIREPLACE

Fees for professional services through Jun 30, 2001	\$180.00
Expense advances through Jun 30, 2001	<u>.00</u>
Current fees and expenses through Jun 30, 2001	\$180.00
Total balance due upon receipt	<u>\$180.00</u>

Payment of this invoice may be made by wire transfer:

BANK OF AMERICA, N.A.
ABA# 111000025
Jenkins & Gilchrist, A Professional Corporation
1445 Ross Avenue, Suite 3200, Dallas, Texas 75202-2799
Account #004772063741
Ref: Client/Matter - Name & Number

JT-APP 2582

Jenkins & Gilchrist
A PROFESSIONAL CORPORATION

PAYMENT REMITTANCE ADDRESS:

P.O. BOX 842552
DALLAS, TEXAS 75284-2552
TAX ID #75-2204006

OFFICE LOCATIONS:

AUSTIN, TEXAS
CHICAGO, ILLINOIS
DALLAS, TEXAS
HOUSTON, TEXAS
LOS ANGELES, CALIFORNIA
SAN ANTONIO, TEXAS
NEW YORK, NEW YORK
WASHINGTON, D.C.

August 13, 2001

ROBERT H. PETERSON COMPANY
CALIFORNIA

Invoice: 902466
Client: 52244
Matter: 00001

Regarding: GAS BURNER FOR FIREPLACE

Fees for professional services through Jul 31, 2001	\$90.00
Expense advances through Jul 31, 2001	<u>.00</u>
Current fees and expenses through Jul 31, 2001	\$90.00
Total balance due upon receipt	<u>\$90.00</u>

A description of these charges is shown on the following pages.

A copy of this page is enclosed; please return it with your payment.

For billing inquiries, please call 214-855-4051. Tax ID# 75-2204006

JT-APP 2583

Jenkins & Gilchrist
A PROFESSIONAL CORPORATION

August 13, 2001

Invoice: 902466
Client: 52244
Matter: 00001

Regarding: GAS BURNER FOR FIREPLACE

Description of Professional Services

07/17/01 ATTEMPTED TELEPHONE CONFERENCE WITH B.
MCLAUGHLIN REGARDING PLEADING AMENDMENT
DEADLINE AND DEADLINE FOR DEFENDANT TO
DESIGNATE EXPERTS (LEFT WORD WITH SECRETARY);
EMAIL COMMUNICATION TO MR. MCLAUGHLIN REGARDING
SAME.
Shareholder: Jerry Selinger

Total fees:

\$90.00

Jenkins & Gilchrist
A PROFESSIONAL CORPORATION

PAYMENT REMITTANCE ADDRESS:

P.O. BOX 842552
DALLAS, TEXAS 75284-2552
TAX ID #75-2204006

OFFICE LOCATIONS:

AUSTIN, TEXAS
CHICAGO, ILLINOIS
DALLAS, TEXAS
HOUSTON, TEXAS
LOS ANGELES, CALIFORNIA
SAN ANTONIO, TEXAS
NEW YORK, NEW YORK
WASHINGTON, D.C.

REMITTANCE ADVICE

August 13, 2001

ROBERT H. PETERSON COMPANY
CALIFORNIA

Invoice: 902466
Client: 52244
Matter: 00001

Regarding: GAS BURNER FOR FIREPLACE

Fees for professional services through Jul 31, 2001	\$90.00
Expense advances through Jul 31, 2001	<u>.00</u>
Current fees and expenses through Jul 31, 2001	\$90.00
Total balance due upon receipt	<u><u>\$90.00</u></u>

Payment of this invoice may be made by wire transfer:

BANK OF AMERICA, N.A.
ABA# 111000025
Jenkins & Gilchrist, A Professional Corporation
1445 Ross Avenue, Suite 3200, Dallas, Texas 75202-2799
Account #004772063741
Ref: Client/Matter - Name & Number

JT-APP 2585

Jenkins & Gilchrist
A PROFESSIONAL CORPORATION

PAYMENT REMITTANCE ADDRESS:

P.O. BOX 842552
DALLAS, TEXAS 75284-2552
TAX ID #75-2204006

OFFICE LOCATIONS:

AUSTIN, TEXAS
CHICAGO, ILLINOIS
DALLAS, TEXAS
HOUSTON, TEXAS
LOS ANGELES, CALIFORNIA
SAN ANTONIO, TEXAS
NEW YORK, NEW YORK
WASHINGTON, D.C.

September 11, 2001

ROBERT H. PETERSON COMPANY
CALIFORNIA

Invoice: 908895
Client: 52244
Matter: 00001

Regarding: GAS BURNER FOR FIREPLACE

Fees for professional services through Aug 31, 2001	\$180.00
Expense advances through Aug 31, 2001	<u>.00</u>
Current fees and expenses through Aug 31, 2001	\$180.00
Total balance due upon receipt	<u><u>\$180.00</u></u>

A description of these charges is shown on the following pages.

A copy of this page is enclosed; please return it with your payment.

For billing inquiries, please call 214-855-4051. Tax ID# 75-2204006

JT-APP 2586

Jenkins & Gilchrist
A PROFESSIONAL CORPORATION

September 11, 2001

Regarding: GAS BURNER FOR FIREPLACE

Invoice: 908895

Client: 52244

Matter: 00001

Description of Professional Services

08/07/01 TELEPHONE CONFERENCE WITH BILL MCLAUGHLIN
REGARDING EXTENSION OF TIME.
Shareholder: Jerry Selinger

08/13/01 TELEPHONE CONFERENCE WITH BILL HARRIS REGARDING
THIRTY-DAY EXTENSION.
Shareholder: Jerry Selinger

Total fees:

\$180.00

Jenkins & Gilchrist
A PROFESSIONAL CORPORATION

PAYMENT REMITTANCE ADDRESS:

P.O. BOX 842552
DALLAS, TEXAS 75284-2552
TAX ID #75-2204006

OFFICE LOCATIONS:

AUSTIN, TEXAS
CHICAGO, ILLINOIS
DALLAS, TEXAS
HOUSTON, TEXAS
LOS ANGELES, CALIFORNIA
SAN ANTONIO, TEXAS
NEW YORK, NEW YORK
WASHINGTON, D.C.

REMITTANCE ADVICE

September 11, 2001

ROBERT H. PETERSON COMPANY
CALIFORNIA

Invoice: 908895
Client: 52244
Matter: 00001

Regarding: GAS BURNER FOR FIREPLACE

Fees for professional services through Aug 31, 2001	\$180.00
Expense advances through Aug 31, 2001	<u>.00</u>
Current fees and expenses through Aug 31, 2001	\$180.00
Total balance due upon receipt	<u><u>\$180.00</u></u>

Payment of this invoice may be made by wire transfer:

BANK OF AMERICA, N.A.
ABA# 111000025
Jenkins & Gilchrist, A Professional Corporation
1445 Ross Avenue, Suite 3200, Dallas, Texas 75202-2799
Account #004772063741
Ref: Client/Matter - Name & Number

JT-APP 2588

Jenkins & Gilchrist
A PROFESSIONAL CORPORATION

PAYMENT REMITTANCE ADDRESS:

P.O. BOX 842552
DALLAS, TEXAS 75284-2552
TAX ID #75-2204006

OFFICE LOCATIONS:

AUSTIN, TEXAS
CHICAGO, ILLINOIS
DALLAS, TEXAS
HOUSTON, TEXAS
LOS ANGELES, CALIFORNIA
SAN ANTONIO, TEXAS
NEW YORK, NEW YORK
WASHINGTON, D.C.

October 11, 2001

ROBERT H. PETERSON COMPANY
CALIFORNIA

Invoice: 917849
Client: 52244
Matter: 00001

Regarding: GAS BURNER FOR FIREPLACE

Fees for professional services through Sep 30, 2001	\$450.00
Expense advances through Sep 30, 2001	<u>60.00</u>
Current fees and expenses through Sep 30, 2001	\$510.00
Total balance due upon receipt	<u>\$510.00</u>

A description of these charges is shown on the following pages.

A copy of this page is enclosed; please return it with your payment.

For billing inquiries, please call 214-855-4051. Tax ID# 75-2204006

JT-APP 2589

Jenkins & Gilchrist
A PROFESSIONAL CORPORATION

October 11, 2001

Invoice: 917849

Client: 52244

Matter: 00001

Regarding: GAS BURNER FOR FIREPLACE

Description of Professional Services

09/10/01 ATTENTION TO JOINT MOTION TO EXTEND DISCOVERY
CUTOFF; TELEPHONE CONFERENCE WITH B. MCLAUGHLIN
REGARDING SAME.
Shareholder: Jerry Selinger

09/11/01 TELEPHONE CONFERENCE WITH BILL HARRIS REGARDING
EXTENSION.
Shareholder: Jerry Selinger

09/20/01 TELEPHONE CONFERENCE WITH R. HARDIN REGARDING
MOTION TO WITHDRAW AS COUNSEL.
Shareholder: Jerry Selinger

09/21/01 REVIEW MOTION TO WITHDRAW (HARDIN FOR BLOUNT);
TRANSMIT SAME TO CLIENT.
Shareholder: Jerry Selinger

09/25/01 REVIEW ORDER GRANTING R. HARDIN'S MOTION TO
WITHDRAW; TRANSMIT SAME TO CLIENT.
Shareholder: Jerry Selinger

Total fees: \$450.00

Jenkins & Gilchrist
A PROFESSIONAL CORPORATION

October 11, 2001

Invoice: 917849
Client: 52244
Matter: 00001

Regarding: GAS BURNER FOR FIREPLACE

Description of Expense Advances

<u>DATE</u>	<u>DESCRIPTION</u>	<u>AMOUNT</u>
09/10/01	Fax	4.00
09/13/01	Copies	5.00
09/17/01	Fax	2.00
09/25/01	Fax	5.00
09/25/01	Fax-Long Distance	1.00
09/26/01	Fax	2.00
09/26/01	Fax-Long Distance	41.00
Total expenses:		\$60.00

Jenkins & Gilchrist

A PROFESSIONAL CORPORATION

PAYMENT REMITTANCE ADDRESS:

P.O. BOX 842552
DALLAS, TEXAS 75284-2552
TAX ID #75-2204006

OFFICE LOCATIONS:

AUSTIN, TEXAS
CHICAGO, ILLINOIS
DALLAS, TEXAS
HOUSTON, TEXAS
LOS ANGELES, CALIFORNIA
SAN ANTONIO, TEXAS
NEW YORK, NEW YORK
WASHINGTON, D.C.

REMITTANCE ADVICE

October 11, 2001

ROBERT H. PETERSON COMPANY
CALIFORNIA

Invoice: 917849
Client: 52244
Matter: 00001

Regarding: GAS BURNER FOR FIREPLACE

Fees for professional services through Sep 30, 2001	\$450.00
Expense advances through Sep 30, 2001	<u>60.00</u>
Current fees and expenses through Sep 30, 2001	\$510.00
Total balance due upon receipt	<u><u>\$510.00</u></u>

Payment of this invoice may be made by wire transfer:

BANK OF AMERICA, N.A.

ABA# 111000025

Jenkins & Gilchrist, A Professional Corporation

1445 Ross Avenue, Suite 3200, Dallas, Texas 75202-2799

Account #004772063741

Ref: Client/Matter - Name & Number

JT-APP 2592

Jenkins & Gilchrist
A PROFESSIONAL CORPORATION

PAYMENT REMITTANCE ADDRESS:

P.O. BOX 842552
DALLAS, TEXAS 75284-2552
TAX ID #75-2204006

OFFICE LOCATIONS:

AUSTIN, TEXAS
CHICAGO, ILLINOIS
DALLAS, TEXAS
HOUSTON, TEXAS
LOS ANGELES, CALIFORNIA
SAN ANTONIO, TEXAS
NEW YORK, NEW YORK
WASHINGTON, D.C.

November 14, 2001

ROBERT H. PETERSON COMPANY
CALIFORNIA

Invoice: 930060
Client: 52244
Matter: 00001

Regarding: GAS BURNER FOR FIREPLACE

Fees for professional services through Oct 31, 2001	\$315.00
Expense advances through Oct 31, 2001	<u>.00</u>
Current fees and expenses through Oct 31, 2001	\$315.00
Total balance due upon receipt	<u>\$315.00</u>

A description of these charges is shown on the following pages.

A copy of this page is enclosed; please return it with your payment.

For billing inquiries, please call 214-855-4051. Tax ID# 75-2204006

JT-APP 2593

Jenkins & Gilchrist
A PROFESSIONAL CORPORATION

November 14, 2001

Invoice: 930060

Client: 52244

Matter: 00001

Regarding: GAS BURNER FOR FIREPLACE

Description of Professional Services

- 10/12/01 REVIEW MOTION IN LIMINE FROM B. HARRIS.
Shareholder: Jerry Selinger
- 10/15/01 TELEPHONE CONFERENCE WITH B. MCLAUGHLIN
REGARDING MOTION FROM HARRIS.
Shareholder: Jerry Selinger
- 10/30/01 ATTENTION TO MEMORANDUM IN OPPOSITION TO GOLDEN
BLOUNT'S MOTION IN LIMINE.
Shareholder: Jerry Selinger

Total fees:

\$315.00

Jenkins & Gilchrist
A PROFESSIONAL CORPORATION

PAYMENT REMITTANCE ADDRESS:

P.O. BOX 842552
DALLAS, TEXAS 75284-2552
TAX ID #75-2204006

OFFICE LOCATIONS:

AUSTIN, TEXAS
CHICAGO, ILLINOIS
DALLAS, TEXAS
HOUSTON, TEXAS
LOS ANGELES, CALIFORNIA
SAN ANTONIO, TEXAS
NEW YORK, NEW YORK
WASHINGTON, D.C.

REMITTANCE ADVICE

November 14, 2001

ROBERT H. PETERSON COMPANY
CALIFORNIA

Invoice: 930060
Client: 52244
Matter: 00001

Regarding: GAS BURNER FOR FIREPLACE

Fees for professional services through Oct 31, 2001	\$315.00
Expense advances through Oct 31, 2001	<u>.00</u>
Current fees and expenses through Oct 31, 2001	\$315.00
Total balance due upon receipt	<u>\$315.00</u>

Payment of this invoice may be made by wire transfer:

BANK OF AMERICA, N.A.
ABA# 111000025
Jenkins & Gilchrist, A Professional Corporation
1445 Ross Avenue, Suite 3200, Dallas, Texas 75202-2799
Account #004772063741
Ref: Client/Matter - Name & Number

JT-APP 2595

Jenkins & Gilchrist

A PROFESSIONAL CORPORATION

PAYMENT REMITTANCE ADDRESS:

F.O. BOX 842552
DALLAS, TEXAS 75284-2552
TAX ID #75-2204006

OFFICE LOCATIONS:

AUSTIN, TEXAS
CHICAGO, ILLINOIS
DALLAS, TEXAS
HOUSTON, TEXAS
LOS ANGELES, CALIFORNIA
SAN ANTONIO, TEXAS
NEW YORK, NEW YORK
WASHINGTON, D.C.

December 11, 2001

ROBERT H. PETERSON COMPANY
CALIFORNIA

Invoice: 940491
Client: 52244
Matter: 00001

Regarding: GAS BURNER FOR FIREPLACE

Fees for professional services through Nov 30, 2001	\$1,170.00
Expense advances through Nov 30, 2001	<u>18.86</u>
Current fees and expenses through Nov 30, 2001	\$1,188.86
Total balance due upon receipt	<u><u>\$1,188.86</u></u>

A description of these charges is shown on the following pages.

A copy of this page is enclosed; please return it with your payment.

For billing inquiries, please call 214-855-4051. Tax ID# 75-2204006

JT-APP 2596

Jenkins & Gilchrist
A PROFESSIONAL CORPORATION

December 11, 2001

Invoice: 940491
Client: 52244
Matter: 00001

Regarding: GAS BURNER FOR FIREPLACE

Description of Professional Services

- 11/13/01 TELEPHONE CONFERENCE WITH CLERK OF JUDGE STICKNEY'S COURT REGARDING MOTION HEARING; ATTEMPTED TELEPHONE CONFERENCE WITH B. HARRIS AND B. MCLAUGHLIN REGARDING SAME AND RESCHEDULING.
Shareholder: Jerry Selinger
- 11/14/01 REVIEW ORDER RESETTING HEARING ON MOTION IN LIMINE TO 11/26/01; TRANSMIT SAME TO CLIENT.
Shareholder: Jerry Selinger
- 11/26/01 PREPARE FOR AND ATTEND HEARING ON MOTION IN LIMINE; TELEPHONE CONFERENCE WITH B. MCLAUGHLIN REGARDING OUTCOME.
Shareholder: Jerry Selinger
- 11/27/01 REVIEW ORDER REGARDING PLAINTIFF'S MOTION IN LIMINE AND REGARDING MCLAUGHLIN DEPOSITION; TRANSMIT SAME TO CLIENT.
Shareholder: Jerry Selinger
- 11/30/01 TELEPHONE CONFERENCE WITH BILL HARRIS REGARDING ORDER; FOLLOW- UP TELEPHONE CONFERENCE WITH BILL MCLAUGHLIN.
Shareholder: Jerry Selinger

Total fees: \$1,170.00

Jenkins & Gilchrist
A PROFESSIONAL CORPORATION

December 11, 2001

Invoice: 940491
Client: 52244
Matter: 00001

Regarding: GAS BURNER FOR FIREPLACE

Description of Expense Advances

<u>DATE</u>	<u>DESCRIPTION</u>	<u>AMOUNT</u>
11/01/01	Copies	17.60
11/01/01	Postage	1.26
Total expenses:		\$18.86

Jenkins & Gilchrist
A PROFESSIONAL CORPORATION

PAYMENT REMITTANCE ADDRESS:

P.O. BOX 842552
DALLAS, TEXAS 75284-2552
TAX ID #75-2204004

OFFICE LOCATIONS:

AUSTIN, TEXAS
CHICAGO, ILLINOIS
DALLAS, TEXAS
HOUSTON, TEXAS
LOS ANGELES, CALIFORNIA
SAN ANTONIO, TEXAS
NEW YORK, NEW YORK
WASHINGTON, D.C.

REMITTANCE ADVICE

December 11, 2001

ROBERT H. PETERSON COMPANY
CALIFORNIA

Invoice: 940491
Client: 52244
Matter: 00001

Regarding: GAS BURNER FOR FIREPLACE

Fees for professional services through Nov 30, 2001	\$1,170.00
Expense advances through Nov 30, 2001	<u>18.86</u>
Current fees and expenses through Nov 30, 2001	\$1,188.86
Total balance due upon receipt	<u>\$1,188.86</u>

Payment of this invoice may be made by wire transfer:

BANK OF AMERICA, N.A.
ABA# 111000025
Jenkins & Gilchrist, A Professional Corporation
1445 Ross Avenue, Suite 3200, Dallas, Texas 75202-2799
Account #004772063741
Ref: Client/Matter - Name & Number

JT-APP 2599

Jenkins & Gilchrist
A PROFESSIONAL CORPORATION

PAYMENT REMITTANCE ADDRESS:

P.O. BOX 842552
DALLAS, TEXAS 75284-2552
TAX ID #75-2204006

OFFICE LOCATIONS:

AUSTIN, TEXAS
CHICAGO, ILLINOIS
DALLAS, TEXAS
HOUSTON, TEXAS
LOS ANGELES, CALIFORNIA
SAN ANTONIO, TEXAS
NEW YORK, NEW YORK
WASHINGTON, D.C.

January 10, 2002

ROBERT H. PETERSON COMPANY
CALIFORNIA

Invoice: 951548
Client: 52244
Matter: 00001

Regarding: GAS BURNER FOR FIREPLACE

Fees for professional services through Dec 31, 2001	\$4,515.00
Expense advances through Dec 31, 2001	<u>.00</u>
Current fees and expenses through Dec 31, 2001	\$4,515.00
Total balance due upon receipt	<u>\$4,515.00</u>

A description of these charges is shown on the following pages.

A copy of this page is enclosed; please return it with your payment.

For billing inquiries, please call 214-855-4051. Tax ID# 75-2204006

JT-APP 2600

Jenkins & Gilchrist
A PROFESSIONAL CORPORATION

January 10, 2002

Invoice: 951548
Client: 52244
Matter: 00001

Regarding: GAS BURNER FOR FIREPLACE

Description of Professional Services

- 12/05/01 TELEPHONE CONFERENCE WITH B. MCLAUGHLIN
REGARDING PRODUCTION ISSUES.
Shareholder: Jerry Selinger
- 12/12/01 TELEPHONE CONFERENCE WITH B. MCLAUGHLIN
REGARDING DEPOSITION; TELEPHONE CONFERENCE WITH
B. HARRIS REGARDING SCHEDULE AND LOCATION OF
DEPOSITIONS.
Shareholder: Jerry Selinger
- 12/14/01 TELEPHONE CONFERENCE WITH JERRY SELINGER
REGARDING DEFENSE OF MCLAUGHLIN'S DEPOSITION
AND RELATED ISSUES.
Counsel: Susan Powley
- 12/16/01 REVIEW OF CASE FILE IN PREPARATION FOR
DEPOSITION DEFENSE.
Counsel: Susan Powley
- 12/17/01 PREPARE LEGAL MEMORANDUM REGARDING SCOPE OF
WAIVER FOR BILL MCLAUGHLIN; TELEPHONE
CONFERENCE WITH BILL MCLAUGHLIN REGARDING
DEPOSITION PREPARATION; FURTHER REVIEW OF CASE
FILE.
Counsel: Susan Powley
- 12/18/01 TELEPHONE CONFERENCE WITH BILL MCLAUGHLIN
REGARDING DEPOSITION ISSUES; CONFERENCE WITH
JERRY SELINGER REGARDING SAME; PREPARATION FOR
DEPOSITION DEFENSE; BRIEF REVIEW OF BORTZ
DEPOSITION TRANSCRIPT.
Counsel: Susan Powley
- 12/19/01 DEFENSE OF MCLAUGHLIN AND BORTZ DEPOSITION;
PREPARATION FOR SAME AND RELATED CONFERENCES
WITH DEponents.
Counsel: Susan Powley

Jenkins & Gilchrist
A PROFESSIONAL CORPORATION

January 10, 2002

Invoice: 951548

Client: 52244

Matter: 00001

Regarding: GAS BURNER FOR FIREPLACE

Total fees:

\$4,515.00

Jenkins & Gilchrist
A PROFESSIONAL CORPORATION

PAYMENT REMITTANCE ADDRESS:

P.O. BOX 842552
DALLAS, TEXAS 75284-2552
TAX ID #75-2204004

OFFICE LOCATIONS:

AUSTIN, TEXAS
CHICAGO, ILLINOIS
DALLAS, TEXAS
HOUSTON, TEXAS
LOS ANGELES, CALIFORNIA
SAN ANTONIO, TEXAS
NEW YORK, NEW YORK
WASHINGTON, D.C.

REMITTANCE ADVICE

January 10, 2002

ROBERT H. PETERSON COMPANY
CALIFORNIA

Invoice: 951548
Client: 52244
Matter: 00001

Regarding: GAS BURNER FOR FIREPLACE

Fees for professional services through Dec 31, 2001	\$4,515.00
Expense advances through Dec 31, 2001	<u>.00</u>
Current fees and expenses through Dec 31, 2001	\$4,515.00
Total balance due upon receipt	<u>\$4,515.00</u>

Payment of this invoice may be made by wire transfer:

BANK OF AMERICA, N.A.
ABA# 111000025
Jenkins & Gilchrist, A Professional Corporation
1445 Ross Avenue, Suite 3200, Dallas, Texas 75202-2799
Account #004772063741
Ref: Client/Matter - Name & Number

JT-APP 2603

Jenkins & Gilchrist
A PROFESSIONAL CORPORATION

PAYMENT REMITTANCE ADDRESS:

P.O. BOX 842552
DALLAS, TEXAS 75284-2552
TAX ID #75-2204006

OFFICE LOCATIONS:

AUSTIN, TEXAS
CHICAGO, ILLINOIS
DALLAS, TEXAS
HOUSTON, TEXAS
LOS ANGELES, CALIFORNIA
SAN ANTONIO, TEXAS
NEW YORK, NEW YORK
WASHINGTON, D.C.

February 19, 2002

ROBERT H. PETERSON COMPANY
CALIFORNIA

Invoice: 969162
Client: 52244
Matter: 00001

Regarding: GAS BURNER FOR FIREPLACE

Fees for professional services through Jan 31, 2002	\$825.50
Expense advances through Jan 31, 2002	<u>15.57</u>
Current fees and expenses through Jan 31, 2002	\$841.07
Total balance due upon receipt	<u>\$841.07</u>

A description of these charges is shown on the following pages.

A copy of this page is enclosed; please return it with your payment.

For billing inquiries, please call 214-855-4051. Tax ID# 75-2204006

JT-APP 2604

Jenkins & Gilchrist

A PROFESSIONAL CORPORATION

February 19, 2002

Regarding: GAS BURNER FOR FIREPLACE

Invoice: 969162

Client: 52244

Matter: 00001

Description of Professional Services

01/11/02 TELEPHONE CONFERENCE WITH B. MCLAUGHLIN
REGARDING PRETRIAL ORDER.
Shareholder: Jerry Selinger

01/22/02 REVIEW AND FILE PRETRIAL MATERIALS.
Associate: Timothy Ackermann

01/22/02 ASSIST TIM ACKERMAN IN PREPARATION OF AND
FILING OF PRETRIAL DISCLOSURE AND EXHIBIT
LISTS.
Paralegal: Linda Beste

01/28/02 TELEPHONE CONFERENCE WITH J. CLARK REGARDING
JURY INSTRUCTIONS; TRANSMIT SAME TO HIM VIA
FEDERAL EXPRESS.
Shareholder: Jerry Selinger

Total fees:

\$825.50

Jenkins & Gilchrist
A PROFESSIONAL CORPORATION

February 19, 2002

Regarding: GAS BURNER FOR FIREPLACE

Invoice: 969162

Client: 52244

Matter: 00001

Description of Expense Advances

<u>DATE</u>	<u>DESCRIPTION</u>	<u>AMOUNT</u>
01/22/02	Document Express Courier Service	12.37
01/22/02	Postage	3.20
Total expenses:		<hr/> \$15.57

Jenkins & Gilchrist
A PROFESSIONAL CORPORATION

PAYMENT REMITTANCE ADDRESS:

P.O. BOX 842552
DALLAS, TEXAS 75284-2552
TAX ID #75-2204004

OFFICE LOCATIONS:

AUSTIN, TEXAS
CHICAGO, ILLINOIS
DALLAS, TEXAS
HOUSTON, TEXAS
LOS ANGELES, CALIFORNIA
SAN ANTONIO, TEXAS
NEW YORK, NEW YORK
WASHINGTON, D.C.

REMITTANCE ADVICE

February 19, 2002

ROBERT H. PETERSON COMPANY
CALIFORNIA

Invoice: 969162
Client: 52244
Matter: 00001

Regarding: GAS BURNER FOR FIREPLACE

Fees for professional services through Jan 31, 2002	\$825.50
Expense advances through Jan 31, 2002	<u>15.57</u>
Current fees and expenses through Jan 31, 2002	\$841.07
Total balance due upon receipt	<u><u>\$841.07</u></u>

Payment of this invoice may be made by wire transfer:

BANK OF AMERICA, N.A.
ABA# 111000025
Jenkins & Gilchrist, A Professional Corporation
1445 Ross Avenue, Suite 3200, Dallas, Texas 75202-2799
Account #004772063741
Ref: Client/Matter - Name & Number

JT-APP 2607

Jenkins & Gilchrist

A PROFESSIONAL CORPORATION

PAYMENT REMITTANCE ADDRESS:

F.O. BOX 842552
DALLAS, TEXAS 75284-2552
TAX ID #75-2204006

OFFICE LOCATIONS:

AUSTIN, TEXAS
CHICAGO, ILLINOIS
DALLAS, TEXAS
HOUSTON, TEXAS
LOS ANGELES, CALIFORNIA
SAN ANTONIO, TEXAS
NEW YORK, NEW YORK
WASHINGTON, D.C.

March 14, 2002

ROBERT H. PETERSON COMPANY
CALIFORNIA

Invoice: 978125
Client: 52244
Matter: 00001

Regarding: GAS BURNER FOR FIREPLACE

Fees for professional services through Feb 28, 2002	\$624.50
Expense advances through Feb 28, 2002	<u>147.17</u>
Current fees and expenses through Feb 28, 2002	\$771.67
Total balance due upon receipt	<u>\$771.67</u>

A description of these charges is shown on the following pages.

A copy of this page is enclosed; please return it with your payment.

For billing inquiries, please call 214-855-4051. Tax ID# 75-2204006

JT-APP 2608

Jenkins & Gilchrist
A PROFESSIONAL CORPORATION

March 14, 2002

Invoice: 978125
Client: 52244
Matter: 00001

Regarding: GAS BURNER FOR FIREPLACE

Description of Professional Services

- 02/04/02 CONFER WITH TIM ACKERMANN REGARDING PRETRIAL OBJECTIONS DEADLINE, RECEIVING DRAFT DOCUMENT VIA EMAIL, MAKING MINOR CHANGES AND REPORTING TO MR. ACKERMANN FOR FINAL REVIEW.
Paralegal: Linda Beste
- 02/05/02 REVISE, EXECUTE AND FILE OBJECTIONS TO PRETRIAL DESIGNATIONS OF EXHIBITS.
Associate: Timothy Ackermann
- 02/05/02 REVIEW TIM ACKERMANN'S CORRECTIONS TO DEFENDANT'S OBJECTIONS TO PLAINTIFF'S PRE-TRIAL DISCLOSURE, CREATE IN FINAL AND FILE WITH COURT.
Paralegal: Linda Beste
- 02/19/02 TELEPHONE CONFERENCE WITH B. MCLAUGHLIN REGARDING PRETRIAL CONFERENCE.
Shareholder: Jerry Selinger
- 02/20/02 ATTENTION TO FILING AND SERVING PRETRIAL MATERIALS.
Shareholder: Jerry Selinger
- 02/20/02 REVIEW, EXECUTE AND FILE PRETRIAL MATERIALS.
Associate: Timothy Ackermann
- 02/28/02 REVIEW AMENDED SCHEDULING ORDER; REVIEW ORDER ON SIXTY-DAY CONTINUANCE.
Shareholder: Jerry Selinger

Total fees: \$624.50

Jenkins & Gilchrist
A PROFESSIONAL CORPORATION

March 14, 2002

Regarding: GAS BURNER FOR FIREPLACE

Invoice: 978125
Client: 52244
Matter: 00001

Description of Expense Advances

<u>DATE</u>	<u>DESCRIPTION</u>	<u>AMOUNT</u>
01/22/02	Copies	12.60
01/24/02	Copies	2.80
01/25/02	Fax-Local	10.00
01/28/02	Overtime	25.00
02/05/02	Document Express Courier Service	12.37
02/05/02	Copies	4.00
02/05/02	Fax-Local	6.00
02/20/02	Copies	68.80
02/26/02	Copies	5.60
Total expenses:		<hr/> \$147.17

Jenkins & Gilchrist
A PROFESSIONAL CORPORATION

PAYMENT REMITTANCE ADDRESS:

P.O. BOX 842552
DALLAS, TEXAS 75284-2552
TAX ID #75-2204006

OFFICE LOCATIONS:

AUSTIN, TEXAS
CHICAGO, ILLINOIS
DALLAS, TEXAS
HOUSTON, TEXAS
LOS ANGELES, CALIFORNIA
SAN ANTONIO, TEXAS
NEW YORK, NEW YORK
WASHINGTON, D.C.

REMITTANCE ADVICE

March 14, 2002

ROBERT H. PETERSON COMPANY
CALIFORNIA

Invoice: 978125
Client: 52244
Matter: 00001

Regarding: GAS BURNER FOR FIREPLACE

Fees for professional services through Feb 28, 2002	\$624.50
Expense advances through Feb 28, 2002	<u>147.17</u>
Current fees and expenses through Feb 28, 2002	\$771.67
Total balance due upon receipt	<u><u>\$771.67</u></u>

Payment of this invoice may be made by wire transfer:

BANK OF AMERICA, N.A.
ABA# 111000025
Jenkins & Gilchrist, A Professional Corporation
1445 Ross Avenue, Suite 3200, Dallas, Texas 75202-2799
Account #004772063741
Ref: Client/Matter - Name & Number

JT-APP 2611

Jenkins & Gilchrist
A PROFESSIONAL CORPORATION

PAYMENT REMITTANCE ADDRESS:

P.O. BOX 842552
DALLAS, TEXAS 75284-2552
TAX ID #75-2204006

OFFICE LOCATIONS:

AUSTIN, TEXAS
CHICAGO, ILLINOIS
DALLAS, TEXAS
HOUSTON, TEXAS
LOS ANGELES, CALIFORNIA
SAN ANTONIO, TEXAS
NEW YORK, NEW YORK
WASHINGTON, D.C.

April 4, 2002

ROBERT H. PETERSON COMPANY
CALIFORNIA

Invoice: 985536
Client: 52244
Matter: 00001

Regarding: GAS BURNER FOR FIREPLACE

Fees for professional services through Mar 31, 2002	\$1,111.50
Expense advances through Mar 31, 2002	<u>180.70</u>
Current fees and expenses through Mar 31, 2002	\$1,292.20
Total balance due upon receipt	<u>\$1,292.20</u>

A description of these charges is shown on the following pages.

A copy of this page is enclosed; please return it with your payment.

For billing inquiries, please call 214-855-4051. Tax ID# 75-2204006

Jenkins & Gilchrist
A PROFESSIONAL CORPORATION

April 4, 2002

Invoice: 985536
Client: 52244
Matter: 00001

Regarding: GAS BURNER FOR FIREPLACE

Description of Professional Services

- 02/26/02 ATTENTION TO MOTION FOR PROTECTIVE ORDER TO PRECLUDE TESTIMONY OF F. WILLIAM MCLAUGHLIN; FILE AND SERVE SAME.
Shareholder: Jerry Selinger
- 02/27/02 TELEPHONE CONFERENCE WITH B. MCLAUGHLIN REGARDING CONTINUANCE.
Shareholder: Jerry Selinger
- 03/04/02 REVIEW MATERIALS REGARDING PATENT QUESTIONS AND DISCUSSION WITH HSIN-WEI LUANG REGARDING MEMO AND REVISE SAME.
Associate: Timothy Ackermann
- 03/05/02 ATTENTION TO STATUS OF MOTIONS FILED REGARDING SCHEDULING AND MARKMAN HEARING.
Associate: Timothy Ackermann
- 03/08/02 CONFER WITH TIM ACKERMAN AND JERRY SELINGER REGARDING MOST RECENT ORDER ENTERED; REVIEW DOCKET AND FILES REGARDING SAME.
Paralegal: Linda Beste
- 03/11/02 OBTAIN REQUESTED FILE STAMPED DOCUMENTS FROM COURT; ATTEND TO FILES.
Paralegal: Linda Beste

Total fees:

\$1,111.50

Jenkins & Gilchrist
A PROFESSIONAL CORPORATION

April 4, 2002

Invoice: 985536

Client: 52244

Matter: 00001

Regarding: GAS BURNER FOR FIREPLACE

Description of Expense Advances

<u>DATE</u>	<u>DESCRIPTION</u>	<u>AMOUNT</u>
02/21/02	Federal Express Delivery	17.10
02/21/02	Document Express Courier Service	39.90
02/25/02	Document Express Courier Service	23.39
02/26/02	Overtime	50.00
02/27/02	Document Express Courier Service	18.34
02/27/02	Postage	1.02
03/01/02	Copies	.80
03/05/02	Long Distance Charges	1.05
03/05/02	Fax-Long Distance	4.00
03/06/02	Copies	.80
03/11/02	Document Express Courier Service	24.30
Total expenses:		\$180.70

Jenkins & Gilchrist

A PROFESSIONAL CORPORATION

PAYMENT REMITTANCE ADDRESS:

P.O. BOX 842552
DALLAS, TEXAS 75284-2552
TAX ID #75-2204006

OFFICE LOCATIONS:

AUSTIN, TEXAS
CHICAGO, ILLINOIS
DALLAS, TEXAS
HOUSTON, TEXAS
LOS ANGELES, CALIFORNIA
SAN ANTONIO, TEXAS
NEW YORK, NEW YORK
WASHINGTON, D.C.

REMITTANCE ADVICE

April 4, 2002

ROBERT H. PETERSON COMPANY
CALIFORNIA

Invoice: 985536
Client: 52244
Matter: 00001

Regarding: GAS BURNER FOR FIREPLACE

Fees for professional services through Mar 31, 2002	\$1,111.50
Expense advances through Mar 31, 2002	<u>180.70</u>
Current fees and expenses through Mar 31, 2002	\$1,292.20
Total balance due upon receipt	<u>\$1,292.20</u>

Payment of this invoice may be made by wire transfer:
BANK OF AMERICA, N.A.
ABA# 111000025
Jenkins & Gilchrist, A Professional Corporation
1445 Ross Avenue, Suite 3200, Dallas, Texas 75202-2799
Account #004772063741
Ref: Client/Matter - Name & Number

JT-APP 2615

Jenkins & Gilchrist
A PROFESSIONAL CORPORATION

PAYMENT REMITTANCE ADDRESS:

P.O. BOX 842552
DALLAS, TEXAS 75284-2552
TAX ID #75-2204004

OFFICE LOCATIONS:

AUSTIN, TEXAS
CHICAGO, ILLINOIS
DALLAS, TEXAS
HOUSTON, TEXAS
LOS ANGELES, CALIFORNIA
SAN ANTONIO, TEXAS
NEW YORK, NEW YORK
WASHINGTON, D.C.

May 8, 2002

ROBERT H. PETERSON COMPANY
CALIFORNIA

Invoice: 996600
Client: 52244
Matter: 00001

Regarding: GAS BURNER FOR FIREPLACE

Fees for professional services through Apr 30, 2002	\$1,188.00
Expense advances through Apr 30, 2002	<u>80.23</u>
Current fees and expenses through Apr 30, 2002	\$1,268.23
Total balance due upon receipt	<u><u>\$1,268.23</u></u>

A description of these charges is shown on the following pages.

A copy of this page is enclosed; please return it with your payment.

For billing inquiries, please call 214-855-4051. Tax ID# 75-2204006

JT-APP 2616

Jenkins & Gilchrist
A PROFESSIONAL CORPORATION

May 8, 2002

Regarding: GAS BURNER FOR FIREPLACE

Invoice: 996600
Client: 52244
Matter: 00001

Description of Professional Services

- 03/05/02 RECEIVE COMMUNICATION FROM TIM ACKERMANN REGARDING CO-COUNSEL REQUEST OF STATUS OF MOTIONS; REVIEW FILES AND PACER REPORT; PROVIDED INFORMATION AND COPIES OF DOCUMENTS TO MR. ACKERMANN; REVIEW AND ORGANIZE DOCUMENTS; ATTEND TO FILE RECORDS AND INDEX
Paralegal: Linda Beste
- 04/08/02 TELEPHONE CONFERENCE WITH B. MCLAUGHLIN REGARDING FINDINGS OF FACT AND CONCLUSIONS OF LAW.
Shareholder: Jerry Selinger
- 04/08/02 FOLLOW-UP ON MARKMAN SCHEDULING ISSUE WITH COURT CLERK.
Associate: Timothy Ackermann
- 04/18/02 REVIEW PROPOSED FINDINGS OF FACT AND CONCLUSIONS OF LAW; PROVIDE COMMENTS THEREON TO BILL MCLAUGHLIN.
Shareholder: Jerry Selinger
- 04/19/02 ATTENTION TO FILING AND SERVING FINDINGS OF FACT AND CONCLUSIONS OF LAW OF ROBERT H. PETERSON CO.
Shareholder: Jerry Selinger
- 04/19/02 REVIEW PLEADING; FILE AND EXECUTE SAME.
Associate: Timothy Ackermann
- 04/24/02 REVIEW ORDER OF REFERENCE ON PLAINTIFF'S MOTION FOR PROTECTIVE ORDER TO PRECLUDE TESTIMONY OF BILL MCLAUGHLIN; TRNASMIT SAME TO CLIENT.
Shareholder: Jerry Selinger

Total fees:

\$1,188.00

Jenkins & Gilchrist
A PROFESSIONAL CORPORATION

May 8, 2002

Invoice: 996600
Client: 52244
Matter: 00001

Regarding: GAS BURNER FOR FIREPLACE

Description of Expense Advances

<u>DATE</u>	<u>DESCRIPTION</u>	<u>AMOUNT</u>
03/10/02	Overtime	50.00
04/19/02	Document Express Courier Service	12.37
04/19/02	Copies	15.80
04/19/02	Postage	1.03
04/22/02	Postage	1.03
Total expenses:		\$80.23

Jenkins & Gilchrist
A PROFESSIONAL CORPORATION

PAYMENT REMITTANCE ADDRESS:

P.O. BOX 842552
DALLAS, TEXAS 75284-2552
TAX ID #75-2204006

OFFICE LOCATIONS:

AUSTIN, TEXAS
CHICAGO, ILLINOIS
DALLAS, TEXAS
HOUSTON, TEXAS
LOS ANGELES, CALIFORNIA
SAN ANTONIO, TEXAS
NEW YORK, NEW YORK
WASHINGTON, D.C.

REMITTANCE ADVICE

May 8, 2002

ROBERT H. PETERSON COMPANY
CALIFORNIA

Invoice: 996600
Client: 52244
Matter: 00001

Regarding: GAS BURNER FOR FIREPLACE

Fees for professional services through Apr 30, 2002	\$1,188.00
Expense advances through Apr 30, 2002	<u>80.23</u>
Current fees and expenses through Apr 30, 2002	\$1,268.23
Total balance due upon receipt	<u>\$1,268.23</u>

Payment of this invoice may be made by wire transfer:

BANK OF AMERICA, N.A.
ABA# 111000025
Jenkins & Gilchrist, A Professional Corporation
1445 Ross Avenue, Suite 3200, Dallas, Texas 75202-2799
Account #004772063741
Ref: Client/Matter - Name & Number

JT-APP 2619

Jenkins & Gilchrist
A PROFESSIONAL CORPORATION

PAYMENT REMITTANCE ADDRESS:

P.O. BOX 842552
DALLAS, TEXAS 75284-2552
TAX ID #75-2204006

OFFICE LOCATIONS:

AUSTIN, TEXAS
CHICAGO, ILLINOIS
DALLAS, TEXAS
HOUSTON, TEXAS
LOS ANGELES, CALIFORNIA
SAN ANTONIO, TEXAS
NEW YORK, NEW YORK
WASHINGTON, D.C.

June 7, 2002

ROBERT H. PETERSON COMPANY
CALIFORNIA

Invoice: 1005496
Client: 52244
Matter: 00001

Regarding: GAS BURNER FOR FIREPLACE

Fees for professional services through May 31, 2002	\$3,137.50
Expense advances through May 31, 2002	<u>30.40</u>
Current fees and expenses through May 31, 2002	\$3,167.90
Total balance due upon receipt	<u>\$3,167.90</u>

A description of these charges is shown on the following pages.

A copy of this page is enclosed; please return it with your payment.

For billing inquiries, please call 214-855-4051. Tax ID# 75-2204006

JT-APP 2620

Jenkins & Gilchrist
A PROFESSIONAL CORPORATION

June 7, 2002

Invoice: 1005496
Client: 52244
Matter: 00001

Regarding: GAS BURNER FOR FIREPLACE

Description of Professional Services

05/03/02 MEETING WITH B. MCLAUGHLIN AND D. MONCO; ATTEND
PRETRIAL CONFERENCE; FOLLOW UP REGARDING LAWYER
TESTIMONY.
Shareholder: Jerry Selinger

05/06/02 TELEPHONE CONFERENCE WITH B. MCLAUGHLIN
REGARDING MOTION TO QUASH.
Shareholder: Jerry Selinger

05/28/02 ATTENTION TO 5/31/02 HEARING; ATTENTION TO
FILING AND SERVING RESPONDING BRIEF REGARDING
CLAIM CONSTRUCTION.
Shareholder: Jerry Selinger

05/28/02 CONFERENCE WITH J. SELINGER REGARDING MOTION
FOR PROTECTIVE ORDER; REVIEW BRIEFING ON
MOTION; REVIEW S. POWLEY RESEARCH MEMO ON
WAIVER ISSUE.
Shareholder: Pat Heptig

05/30/02 RESEARCH CASE LAW ON WAIVER OF PRIVILEGE
ISSUES; PREPARE FOR HEARING ON MOTION FOR
PROTECTIVE ORDER.
Shareholder: Pat Heptig

05/30/02 COPY CASES FROM WESTLAW FOR PAT HEPTIG AND
PREPARE NOTEBOOK IN PREPARATION OF MOTION FOR
PROTECTIVE ORDER HEARING
Paralegal: Kimberly Winiger

05/31/02 OFFICE CONFERENCE WITH P. HEPTIG REGARDING
HEARING RESULTS; FOLLOW-UP TELEPHONE CALL TO B.
MCLAUGHLIN.
Shareholder: Jerry Selinger

05/31/02 PREPARE FOR AND ATTEND HEARING ON MOTION FOR
PROTECTIVE ORDER; CONFERENCE WITH J. SELINGER
REGARDING SAME.
Shareholder: Pat Heptig

Jenkins & Gilchrist
A PROFESSIONAL CORPORATION

June 7, 2002

Regarding: GAS BURNER FOR FIREPLACE

Invoice: 1005496

Client: 52244

Matter: 00001

Description of Professional Services

Total fees:

\$3,137.50

Jenkins & Gilchrist
A PROFESSIONAL CORPORATION

June 7, 2002

Invoice: 1005496
Client: 52244
Matter: 00001

Regarding: GAS BURNER FOR FIREPLACE

Description of Expense Advances

<u>DATE</u>	<u>DESCRIPTION</u>	<u>AMOUNT</u>
05/03/02	Parking	7.00
05/24/02	Copies	.40
05/28/02	Copies	16.20
05/29/02	Copies	3.80
05/30/02	Copies	3.00
Total expenses:		<hr/> \$30.40

Jenkins & Gilchrist
A PROFESSIONAL CORPORATION

PAYMENT REMITTANCE ADDRESS:

P.O. BOX 842552
DALLAS, TEXAS 75284-2552
TAX ID #75-2204006

OFFICE LOCATIONS:

AUSTIN, TEXAS
CHICAGO, ILLINOIS
DALLAS, TEXAS
HOUSTON, TEXAS
LOS ANGELES, CALIFORNIA
SAN ANTONIO, TEXAS
NEW YORK, NEW YORK
WASHINGTON, D.C.

REMITTANCE ADVICE

June 7, 2002

ROBERT H. PETERSON COMPANY
CALIFORNIA

Invoice: 1005496
Client: 52244
Matter: 00001

Regarding: GAS BURNER FOR FIREPLACE

Fees for professional services through May 31, 2002	\$3,137.50
Expense advances through May 31, 2002	<u>30.40</u>
Current fees and expenses through May 31, 2002	\$3,167.90
Total balance due upon receipt	<u>\$3,167.90</u>

Payment of this invoice may be made by wire transfer:

BANK OF AMERICA, N.A.
ABA# 111000025
Jenkins & Gilchrist, A Professional Corporation
1445 Ross Avenue, Suite 3200, Dallas, Texas 75202-2799
Account #004772063741
Ref: Client/Matter - Name & Number

Jenkins & Gilchrist
A PROFESSIONAL CORPORATION

PAYMENT REMITTANCE ADDRESS:

P.O. BOX 842552
DALLAS, TEXAS 75284-2552
TAX ID #75-2204004

OFFICE LOCATIONS:

AUSTIN, TEXAS
CHICAGO, ILLINOIS
DALLAS, TEXAS
HOUSTON, TEXAS
LOS ANGELES, CALIFORNIA
SAN ANTONIO, TEXAS
NEW YORK, NEW YORK
WASHINGTON, D.C.

July 9, 2002

ROBERT H. PETERSON COMPANY
CALIFORNIA

Invoice: 1017331
Client: 52244
Matter: 00001

Regarding: GAS BURNER FOR FIREPLACE

Fees for professional services through Jun 30, 2002	\$278.50
Expense advances through Jun 30, 2002	<u>276.22</u>
Current fees and expenses through Jun 30, 2002	\$554.72
Total balance due upon receipt	<u>\$554.72</u>

A description of these charges is shown on the following pages.

A copy of this page is enclosed; please return it with your payment.

For billing inquiries, please call 214-855-4051. Tax ID# 75-2204006

JT-APP 2625

Jenkins & Gilchrist
A PROFESSIONAL CORPORATION

July 9, 2002

Invoice: 1017331
Client: 52244
Matter: 00001

Regarding: GAS BURNER FOR FIREPLACE

Description of Professional Services

06/07/02 REVIEW ORDER DENYING PETERSON'S MOTION FOR
PROTECTIVE ORDER; TRANSMIT SAME TO CLIENT.
Shareholder: Jerry Selinger

06/20/02 REVIEW DOCKET REGARDING TRIAL DATE AND 282
DEADLINE NOTICE; CONFERENCE WITH JERRY SELINGER
REGARDING SAME; E-MAIL REMINDER TO BILL
MCLAUGHLIN REGARDING UPCOMING 282 NOTICE
DEADLINE.
Counsel: Susan Powley

06/21/02 ATTENTION TO 282 REMINDER.
Shareholder: Jerry Selinger

Total fees: \$278.50

Jenkins & Gilchrist
A PROFESSIONAL CORPORATION

July 9, 2002

Invoice: 1017331
Client: 52244
Matter: 00001

Regarding: GAS BURNER FOR FIREPLACE

Description of Expense Advances

<u>DATE</u>	<u>DESCRIPTION</u>	<u>AMOUNT</u>
05/28/02	Document Express Courier Service	33.67
05/28/02	Overtime	25.00
05/29/02	Federal Express Delivery	10.28
05/30/02	Westlaw Research	188.70
06/26/02	Document Express Courier Service	12.37
06/26/02	Copies	6.20
Total expenses:		\$276.22

Jenkins & Gilchrist

A PROFESSIONAL CORPORATION

PAYMENT REMITTANCE ADDRESS:

P.O. BOX 842552
DALLAS, TEXAS 75284-2552
TAX ID #75-2204006

OFFICE LOCATIONS:

AUSTIN, TEXAS
CHICAGO, ILLINOIS
DALLAS, TEXAS
HOUSTON, TEXAS
LOS ANGELES, CALIFORNIA
SAN ANTONIO, TEXAS
NEW YORK, NEW YORK
WASHINGTON, D.C.

REMITTANCE ADVICE

July 9, 2002

ROBERT H. PETERSON COMPANY
CALIFORNIA

Invoice: 1017331
Client: 52244
Matter: 00001

Regarding: GAS BURNER FOR FIREPLACE

Fees for professional services through Jun 30, 2002	\$278.50
Expense advances through Jun 30, 2002	<u>276.22</u>
Current fees and expenses through Jun 30, 2002	\$554.72
Total balance due upon receipt	<u><u>\$554.72</u></u>

Payment of this invoice may be made by wire transfer:

BANK OF AMERICA, N.A.

ABA# 111000025

Jenkins & Gilchrist, A Professional Corporation

1445 Ross Avenue, Suite 3200, Dallas, Texas 75202-2799

Account #004772063741

Ref: Client/Matter - Name & Number

JT-APP 2628

Jenkins & Gilchrist
A PROFESSIONAL CORPORATION

PAYMENT REMITTANCE ADDRESS:

P.O. BOX 842552
DALLAS, TEXAS 75284-2552
TAX ID #75-2204006

OFFICE LOCATIONS:

AUSTIN, TEXAS
CHICAGO, ILLINOIS
DALLAS, TEXAS
HOUSTON, TEXAS
LOS ANGELES, CALIFORNIA
SAN ANTONIO, TEXAS
NEW YORK, NEW YORK
WASHINGTON, D.C.

August 8, 2002

ROBERT H. PETERSON COMPANY
CALIFORNIA

Invoice: 1030446
Client: 52244
Matter: 00001

Regarding: GAS BURNER FOR FIREPLACE

Fees for professional services through Jul 31, 2002	\$2,565.00
Expense advances through Jul 31, 2002	<u>236.16</u>
Current fees and expenses through Jul 31, 2002	\$2,801.16
Total balance due upon receipt	<u>\$2,801.16</u>

A description of these charges is shown on the following pages.

A copy of this page is enclosed; please return it with your payment.

For billing inquiries, please call 214-855-4051. Tax ID# 75-2204006

JT-APP 2629

Jenkins & Gilchrist
A PROFESSIONAL CORPORATION

August 8, 2002

Invoice: 1030446
Client: 52244
Matter: 00001

Regarding: GAS BURNER FOR FIREPLACE

Description of Professional Services

07/10/02 TELEPHONE CONFERENCE WITH D. MONCO REGARDING
DEADLINE FOR FILING AND EXCHANGING TRIAL
EXHIBITS.

Shareholder: Jerry Selinger

07/11/02 TELEPHONE CONFERENCE WITH JUDGE'S SECRETARY AND
LAW CLERK CONFIRMING DEADLINE TO EXCHANGE AND
FILE TRIAL EXHIBITS; CONFIRM SAME WITH D.
MONCO.

Shareholder: Jerry Selinger

07/12/02 FILE AND SERVE DEFENDANT'S TRIAL EXHIBITS.

Shareholder: Jerry Selinger

07/16/02 TELEPHONE CONFERENCE WITH D. MONCO REGARDING
VARIOUS TRIAL-RELATED ISSUES; TELEPHONE
CONFERENCE WITH LAW CLERK REGARDING SAME AND
REGARDING EXHIBIT EXCHANGE.

Shareholder: Jerry Selinger

07/17/02 RECEIVE AND TRANSMIT GOLDEN BLOUNT'S TRIAL
EXHIBITS TO CLIENT; TRANSMIT FINDINGS OF FACT
AND CONCLUSIONS OF LAW ON CD TO LAW CLERK.

Shareholder: Jerry Selinger

07/22/02 TELEPHONE CONFERENCE WITH D. MONCO REGARDING
TRIAL ISSUES.

Shareholder: Jerry Selinger

07/26/02 TELEPHONE CONFERENCE WITH CLIENT REGARDING
STRATEGY ISSUES.

Shareholder: Jerry Selinger

07/29/02 ATTEND OPENING OF BENCH TRIAL

Shareholder: Jerry Selinger

07/31/02 ATTEND CLOSING ARGUMENTS.

Shareholder: Jerry Selinger

Jenkins & Gilchrist
A PROFESSIONAL CORPORATION

August 8, 2002

Regarding: GAS BURNER FOR FIREPLACE

Invoice: 1030446
Client: 52244
Matter: 00001

Total fees: \$2,565.00

Jenkins & Gilchrist
A PROFESSIONAL CORPORATION

August 8, 2002

Regarding: GAS BURNER FOR FIREPLACE

Invoice: 1030446
Client: 52244
Matter: 00001

Description of Expense Advances

<u>DATE</u>	<u>DESCRIPTION</u>	<u>AMOUNT</u>
07/12/02	Document Express Courier Service	33.67
07/12/02	Copies	58.80
07/17/02	Document Express Courier Service	6.19
07/26/02	Application Fee	50.00
07/26/02	Document Express Courier Service	27.97
07/26/02	Copies	4.80
07/31/02	Parking	7.00
07/31/02	Meal Expense	47.73
Total expenses:		<hr/> \$236.16

Jenkins & Gilchrist
A PROFESSIONAL CORPORATION

PAYMENT REMITTANCE ADDRESS:

P.O. BOX 842552
DALLAS, TEXAS 75284-2552
TAX ID #75-2204006

OFFICE LOCATIONS:

AUSTIN, TEXAS
CHICAGO, ILLINOIS
DALLAS, TEXAS
HOUSTON, TEXAS
LOS ANGELES, CALIFORNIA
SAN ANTONIO, TEXAS
NEW YORK, NEW YORK
WASHINGTON, D.C.

REMITTANCE ADVICE

August 8, 2002

ROBERT H. PETERSON COMPANY
CALIFORNIA

Invoice: 1030446
Client: 52244
Matter: 00001

Regarding: GAS BURNER FOR FIREPLACE

Fees for professional services through Jul 31, 2002	\$2,565.00
Expense advances through Jul 31, 2002	<u>236.16</u>
Current fees and expenses through Jul 31, 2002	\$2,801.16
Total balance due upon receipt	<u>\$2,801.16</u>

Payment of this invoice may be made by wire transfer:
BANK OF AMERICA, N.A.
ABA# 111000025
Jenkins & Gilchrist, A Professional Corporation
1445 Ross Avenue, Suite 3200, Dallas, Texas 75202-2799
Account #004772063741
Ref: Client/Matter - Name & Number

JT-APP 2633

Jenkins & Gilchrist

A PROFESSIONAL CORPORATION

PAYMENT REMITTANCE ADDRESS:

P.O. BOX 842552
DALLAS, TEXAS 75284-2552
TAX ID #75-2204006

OFFICE LOCATIONS:

AUSTIN, TEXAS
CHICAGO, ILLINOIS
DALLAS, TEXAS
HOUSTON, TEXAS
LOS ANGELES, CALIFORNIA
SAN ANTONIO, TEXAS
NEW YORK, NEW YORK
WASHINGTON, D.C.

September 9, 2002

ROBERT H. PETERSON COMPANY
CALIFORNIA

Invoice: 1041585
Client: 52244
Matter: 00001

Regarding: GAS BURNER FOR FIREPLACE

Fees for professional services through Aug 31, 2002	\$779.00
Expense advances through Aug 31, 2002	<u>2,981.90</u>
Current fees and expenses through Aug 31, 2002	\$3,760.90
Total balance due upon receipt	<u>\$3,760.90</u>

A description of these charges is shown on the following pages.

A copy of this page is enclosed; please return it with your payment.

For billing inquiries, please call 214-855-4051. Tax ID# 75-2204006

JT-APP 2634

Jenkins & Gilchrist
A PROFESSIONAL CORPORATION

September 9, 2002

Regarding: GAS BURNER FOR FIREPLACE

Invoice: 1041585

Client: 52244

Matter: 00001

Description of Professional Services

08/12/02 TELEPHONE CONFERENCE WITH COURT REGARDING ENTRY OF JUDGMENT FOR POST-JUDGMENT MOTION DEADLINE CALCULATIONS; ATTENTION TO OBTAINING TRIAL TRANSCRIPT; RECEIVE AND REVIEW FINDINGS AND CONCLUSIONS; TELEPHONE CONFERENCE WITH D. MONCO REGARDING SAME.

Shareholder: Jerry Selinger

08/13/02 CONTINUED ATTENTION TO OBTAINING TRIAL TRANSCRIPT ON EXPEDITED BASIS; TELEPHONE CONFERENCE WITH D. MONCO REGARDING CASE.

Shareholder: Jerry Selinger

08/15/02 TRANSMIT TRIAL TARNSCRIPT (DAY ONE) TO CLIENT; REVIEW JOINT MOTION REGARDING SEALED DOCUMENTS; TRANSMIT SAME TO D. MONCO; TELEPHONE CONFERENCE WITH D. MONCO REGARDING NOT FILING SAME.

Shareholder: Jerry Selinger

08/23/02 ATTENTION TO RULE 52 AND 59 MOTIONS; TELEPHONE CONFERENCE WITH D. MONCO REGARDING SAME; ATTENTION TO FILING AND SERVING SAME.

Shareholder: Jerry Selinger

08/23/02 REVIEW AND SIGN POST-TRIAL MOTIONS; ATTENTION TO EVIDENCE ISSUES.

Shareholder: Pat Heptig

Total fees:

\$779.00

Jenkins & Gilchrist
A PROFESSIONAL CORPORATION

September 9, 2002

Invoice: 1041585
Client: 52244
Matter: 00001

Regarding: GAS BURNER FOR FIREPLACE

Description of Expense Advances

<u>DATE</u>	<u>DESCRIPTION</u>	<u>AMOUNT</u>
07/16/02	Overtime	50.00
07/17/02	Federal Express Delivery	41.09
07/29/02	Document Express Courier Service	23.36
07/29/02	Overtime	25.00
08/02/02	Copies	1.20
08/03/02	Parking	7.00
08/12/02	Copies	5.60
08/15/02	Document Express Courier Service	18.34
08/15/02	Copies	92.20
08/19/02	Transcript - Trial	2,574.50
08/20/02	Document Express Courier Service	18.56
08/20/02	Copies	6.60
08/21/02	Document Express Courier Service	12.37
08/21/02	Copies	17.60
08/23/02	Document Express Courier Service	54.08
08/23/02	Copies	34.40
Total expenses:		\$2,981.90

Jenkins & Gilchrist

A PROFESSIONAL CORPORATION

PAYMENT REMITTANCE ADDRESS:

P.O. BOX 842552
DALLAS, TEXAS 75284-2552
TAX ID #75-2204006

OFFICE LOCATIONS:

AUSTIN, TEXAS
CHICAGO, ILLINOIS
DALLAS, TEXAS
HOUSTON, TEXAS
LOS ANGELES, CALIFORNIA
SAN ANTONIO, TEXAS
NEW YORK, NEW YORK
WASHINGTON, D.C.

REMITTANCE ADVICE

September 9, 2002

ROBERT H. PETERSON COMPANY
CALIFORNIA

Invoice: 1041585
Client: 52244
Matter: 00001

Regarding: GAS BURNER FOR FIREPLACE

Fees for professional services through Aug 31, 2002	\$779.00
Expense advances through Aug 31, 2002	<u>2,981.90</u>
Current fees and expenses through Aug 31, 2002	\$3,760.90
Total balance due upon receipt	<u><u>\$3,760.90</u></u>

Payment of this invoice may be made by wire transfer:
BANK OF AMERICA, N.A.
ABA# 111000025
Jenkins & Gilchrist, A Professional Corporation
1445 Ross Avenue, Suite 3200, Dallas, Texas 75202-2799
Account #004772063741
Ref: Client/Matter - Name & Number

JT-APP 2637

Jenkins & Gilchrist
A PROFESSIONAL CORPORATION

PAYMENT REMITTANCE ADDRESS:

P.O. BOX 842552
DALLAS, TEXAS 75284-2552
TAX ID #75-2204006

OFFICE LOCATIONS:

AUSTIN, TEXAS
CHICAGO, ILLINOIS
DALLAS, TEXAS
HOUSTON, TEXAS
LOS ANGELES, CALIFORNIA
SAN ANTONIO, TEXAS
NEW YORK, NEW YORK
WASHINGTON, D.C.

October 4, 2002

ROBERT H. PETERSON COMPANY
CALIFORNIA

Invoice: 1050537
Client: 52244
Matter: 00001

Regarding: GAS BURNER FOR FIREPLACE

Fees for professional services through Sep 30, 2002	\$560.50
Expense advances through Sep 30, 2002	<u>212.80</u>
Current fees and expenses through Sep 30, 2002	\$773.30
Total balance due upon receipt	<u><u>\$773.30</u></u>

A description of these charges is shown on the following pages.

A copy of this page is enclosed; please return it with your payment.

For billing inquiries, please call 214-855-4051. Tax ID# 75-2204006

JT-APP 2638

Jenkins & Gilchrist
A PROFESSIONAL CORPORATION

October 4, 2002

Invoice: 1050537

Client: 52244

Matter: 00001

Regarding: GAS BURNER FOR FIREPLACE

Description of Professional Services

09/09/02 ATTENTION TO JOINT MOTION FOR EXTENSION OF TIME
TO RESPOND TO POST-TRIAL MOTIONS; FILE SAME.
Shareholder: Jerry Selinger

09/10/02 TELEPHONE CONFERENCE WITH B. MCLAUGHLIN
REGARDING TRANSMITTING HEARING TRANSCRIPT TO
PLAINTIFF'S COUNSEL.
Shareholder: Jerry Selinger

09/11/02 TELEPHONE CONFERENCE WITH C. GAINES REGARDING
PROVIDING TRIAL TRANSCRIPT; ATTENTION TO SAME.
Shareholder: Jerry Selinger

09/12/02 TELEPHONE CONFERENCE WITH LAW CLERK REGARDING
STATUS OF JOINT MOTION FOR EXTENSION REGARDING
POST-TRIAL MOTIONS FILED SEPTEMBER 9, 2002;
TELEPHONE CONFERENCE WITH B. MCLAUGHLIN
REGARDING SAME.
Shareholder: Jerry Selinger

09/19/02 REVIEW AND SIGN OBJECTIONS TO DAMAGE AWARD.
Shareholder: Pat Heptig

Total fees:

\$560.50

Jenkins & Gilchrist
A PROFESSIONAL CORPORATION

October 4, 2002

Invoice: 1050537
Client: 52244
Matter: 00001

Regarding: GAS BURNER FOR FIREPLACE

Description of Expense Advances

<u>DATE</u>	<u>DESCRIPTION</u>	<u>AMOUNT</u>
08/09/02	Fax-Long Distance	2.00
08/12/02	Fax-Long Distance	18.00
08/15/02	Federal Express Delivery	38.76
08/15/02	Fax-Long Distance	3.00
08/21/02	Federal Express Delivery	17.44
08/23/02	Federal Express Delivery	15.50
09/09/02	Document Express Courier Service	5.62
09/09/02	Copies	4.00
09/09/02	Fax-Local	1.00
09/12/02	Document Express Courier Service	48.56
09/12/02	Copies	1.60
09/13/02	Fax-Long Distance	2.00
09/19/02	Document Express Courier Service	27.97
09/19/02	Copies	25.60
09/20/02	Postage	1.75
Total expenses:		\$212.80

Jenkins & Gilchrist
A PROFESSIONAL CORPORATION

PAYMENT REMITTANCE ADDRESS:

P.O. BOX 842552
DALLAS, TEXAS 75284-2552
TAX ID #75-2204006

OFFICE LOCATIONS:

AUSTIN, TEXAS
CHICAGO, ILLINOIS
DALLAS, TEXAS
HOUSTON, TEXAS
LOS ANGELES, CALIFORNIA
SAN ANTONIO, TEXAS
NEW YORK, NEW YORK
WASHINGTON, D.C.

REMITTANCE ADVICE

October 4, 2002

ROBERT H. PETERSON COMPANY
CALIFORNIA

Invoice: 1050537
Client: 52244
Matter: 00001

Regarding: GAS BURNER FOR FIREPLACE

Fees for professional services through Sep 30, 2002	\$560.50
Expense advances through Sep 30, 2002	<u>212.80</u>
Current fees and expenses through Sep 30, 2002	\$773.30
Total balance due upon receipt	<u><u>\$773.30</u></u>

Payment of this invoice may be made by wire transfer:

BANK OF AMERICA, N.A.
ABA# 111000025
Jenkins & Gilchrist, A Professional Corporation
1445 Ross Avenue, Suite 3200, Dallas, Texas 75202-2799
Account #004772063741
Ref: Client/Matter - Name & Number

JT-APP 2641

Jenkins & Gilchrist

A PROFESSIONAL CORPORATION

PAYMENT REMITTANCE ADDRESS:

P.O. BOX 842552
DALLAS, TEXAS 75284-2552
TAX ID #75-2204006

OFFICE LOCATIONS:

AUSTIN, TEXAS
CHICAGO, ILLINOIS
DALLAS, TEXAS
HOUSTON, TEXAS
LOS ANGELES, CALIFORNIA
SAN ANTONIO, TEXAS
NEW YORK, NEW YORK
WASHINGTON, D.C.

November 8, 2002

ROBERT H. PETERSON COMPANY
CALIFORNIA

Invoice: 1062688
Client: 52244
Matter: 00001

Regarding: GAS BURNER FOR FIREPLACE

Fees for professional services through Oct 31, 2002	\$237.50
Expense advances through Oct 31, 2002	<u>37.47</u>
Current fees and expenses through Oct 31, 2002	\$274.97
Total balance due upon receipt	<u>\$274.97</u>

A description of these charges is shown on the following pages.

A copy of this page is enclosed; please return it with your payment.

For billing inquiries, please call 214-855-4051. Tax ID# 75-2204006

JT-APP 2642

Jenkins & Gilchrist
A PROFESSIONAL CORPORATION

November 8, 2002

Regarding: GAS BURNER FOR FIREPLACE

Invoice: 1062688
Client: 52244
Matter: 00001

Description of Professional Services

10/04/02 ATTENTION TO REPLY BRIEF; FILE AND SERVE SAME.
Shareholder: Jerry Selinger

Total fees: \$237.50

Jenkins & Gilchrist
A PROFESSIONAL CORPORATION

November 8, 2002

Regarding: GAS BURNER FOR FIREPLACE

Invoice: 1062688
Client: 52244
Matter: 00001

Description of Expense Advances

<u>DATE</u>	<u>DESCRIPTION</u>	<u>AMOUNT</u>
10/04/02	Document Express Courier Service	12.37
10/04/02	Copies	21.60
10/04/02	Postage	1.75
10/05/02	Postage	1.75
Total expenses:		\$37.47

Jenkins & Gilchrist

A PROFESSIONAL CORPORATION

PAYMENT REMITTANCE ADDRESS:

P.O. BOX 842552
DALLAS, TEXAS 75284-2552
TAX ID #75-2204006

OFFICE LOCATIONS:

AUSTIN, TEXAS
CHICAGO, ILLINOIS
DALLAS, TEXAS
HOUSTON, TEXAS
LOS ANGELES, CALIFORNIA
SAN ANTONIO, TEXAS
NEW YORK, NEW YORK
WASHINGTON, D.C.

REMITTANCE ADVICE

November 8, 2002

ROBERT H. PETERSON COMPANY
CALIFORNIA

Invoice: 1062688
Client: 52244
Matter: 00001

Regarding: GAS BURNER FOR FIREPLACE

Fees for professional services through Oct 31, 2002	\$237.50
Expense advances through Oct 31, 2002	<u>37.47</u>
Current fees and expenses through Oct 31, 2002	\$274.97
Total balance due upon receipt	<u>\$274.97</u>

Payment of this invoice may be made by wire transfer:

BANK OF AMERICA, N.A.
ABA# 111000025
Jenkins & Gilchrist, A Professional Corporation
1445 Ross Avenue, Suite 3200, Dallas, Texas 75202-2799
Account #004772063741
Ref: Client/Matter - Name & Number

JT-APP 2645

Jenkins & Gilchrist
A PROFESSIONAL CORPORATION

PAYMENT REMITTANCE ADDRESS:

P.O. BOX 842552
DALLAS, TEXAS 75284-2552
TAX ID #75-2204004

OFFICE LOCATIONS:

AUSTIN, TEXAS
CHICAGO, ILLINOIS
DALLAS, TEXAS
HOUSTON, TEXAS
LOS ANGELES, CALIFORNIA
SAN ANTONIO, TEXAS
NEW YORK, NEW YORK
WASHINGTON, D.C.

March 7, 2003

ROBERT H. PETERSON COMPANY
CALIFORNIA

Invoice: 1105081
Client: 52244
Matter: 00001

Regarding: GAS BURNER FOR FIREPLACE

Fees for professional services through Feb 28, 2003	\$400.00
Expense advances through Feb 28, 2003	<u>35.75</u>
Current fees and expenses through Feb 28, 2003	\$435.75
Total balance due upon receipt	<u><u>\$435.75</u></u>

A description of these charges is shown on the following pages.

A copy of this page is enclosed; please return it with your payment.

For billing inquiries, please call 214-855-4051. Tax ID# 75-2204006

JT-APP 2646

Jenkins & Gilchrist
A PROFESSIONAL CORPORATION

March 7, 2003

Regarding: GAS BURNER FOR FIREPLACE

Invoice: 1105081
Client: 52244
Matter: 00001

Description of Professional Services

02/17/03 TELEPHONE CONFERENCE WITH B. MCLAUGHLIN
REGARDING FEBRUARY 6, 2003 COURT ORDER;
TELEPHONE CONFERENCE WITH B. HARRIS REGARDING
ONE-WEEK EXTENSION OF TIME TO COMPLY; PREPARE
AGREED MOTION AND ORDER TO EXTEND.
Shareholder: Jerry Selinger

02/24/03 ATTENTION TO RESPONSE TO 2/6/03 COURT ORDER;
TELEPHONE CONFERENCE WITH B. MCLAUGHLIN
REGARDING SAME; FILE AND SERVE SAME.
Shareholder: Jerry Selinger

Total fees:

\$400.00

Jenkins & Gilchrist
A PROFESSIONAL CORPORATION

March 7, 2003

Invoice: 1105081
Client: 52244
Matter: 00001

Regarding: GAS BURNER FOR FIREPLACE

Description of Expense Advances

<u>DATE</u>	<u>DESCRIPTION</u>	<u>AMOUNT</u>
02/17/03	Copies	2.40
02/17/03	Fax-Long Distance	3.00
02/18/03	Document Express Courier Service	11.01
02/18/03	Copies	.60
02/18/03	Postage	.37
02/24/03	Document Express Courier Service	12.37
02/24/03	Copies	3.00
02/28/03	Fax	3.00
Total expenses:		\$35.75

Jenkins & Gilchrist

A PROFESSIONAL CORPORATION

PAYMENT REMITTANCE ADDRESS:

P.O. BOX 842552
DALLAS, TEXAS 75284-2552
TAX ID #75-2204006

OFFICE LOCATIONS:

AUSTIN, TEXAS
CHICAGO, ILLINOIS
DALLAS, TEXAS
HOUSTON, TEXAS
LOS ANGELES, CALIFORNIA
SAN ANTONIO, TEXAS
NEW YORK, NEW YORK
WASHINGTON, D.C.

REMITTANCE ADVICE

March 7, 2003

ROBERT H. PETERSON COMPANY
CALIFORNIA

Invoice: 1105081
Client: 52244
Matter: Q0001

Regarding: GAS BURNER FOR FIREPLACE

Fees for professional services through Feb 28, 2003	\$400.00
Expense advances through Feb 28, 2003	<u>35.75</u>
Current fees and expenses through Feb 28, 2003	\$435.75
Total balance due upon receipt	<u><u>\$435.75</u></u>

Payment of this invoice may be made by wire transfer:

BANK OF AMERICA, N.A.

ABA# 111000025

Jenkins & Gilchrist, A Professional Corporation

1445 Ross Avenue, Suite 3200, Dallas, Texas 75202-2799

Account #004772063741

Ref: Client/Matter - Name & Number

JT-APP 2649

Jenkins & Gilchrist

A PROFESSIONAL CORPORATION

PAYMENT REMITTANCE ADDRESS:

P.O. BOX 842552
DALLAS, TEXAS 75284-2552
TAX ID #75-2204006

OFFICE LOCATIONS:

AUSTIN, TEXAS
CHICAGO, ILLINOIS
DALLAS, TEXAS
HOUSTON, TEXAS
LOS ANGELES, CALIFORNIA
SAN ANTONIO, TEXAS
NEW YORK, NEW YORK
WASHINGTON, D.C.

April 9, 2003

ROBERT H. PETERSON COMPANY
CALIFORNIA

Invoice: 1114792
Client: 52244
Matter: 00001

Regarding: GAS BURNER FOR FIREPLACE

Fees for professional services through Mar 31, 2003	\$200.00
Expense advances through Mar 31, 2003	<u>510.08</u>
Current fees and expenses through Mar 31, 2003	\$710.08
Total balance due upon receipt	<u><u>\$710.08</u></u>

A description of these charges is shown on the following pages.

A copy of this page is enclosed; please return it with your payment.

For billing inquiries, please call 214-855-4051. Tax ID# 75-2204006

JT-APP 2650

Jenkins & Gilchrist
A PROFESSIONAL CORPORATION

April 9, 2003

Regarding: GAS BURNER FOR FIREPLACE

Invoice: 1114792
Client: 52244
Matter: 00001

Description of Professional Services

03/03/03 TELEPHONE CONFERENCE WITH B. MCLAUGHLIN
REGARDING APPEAL QUESTIONS; ATTENTION TO NOTICE
OF APPEAL.
Shareholder: Jerry Selinger

03/06/03 ATTENTION TO NOTICE OF APPEAL; FILE AND SERVE
SAME.
Shareholder: Jerry Selinger

Total fees: \$200.00

Jenkins & Gilchrist
A PROFESSIONAL CORPORATION

April 9, 2003

Invoice: 1114792
Client: 52244
Matter: 00001

Regarding: GAS BURNER FOR FIREPLACE

Description of Expense Advances

<u>DATE</u>	<u>DESCRIPTION</u>	<u>AMOUNT</u>
03/03/03	Copies	.20
03/05/03	Overtime	25.00
03/06/03	Copies	19.20
03/06/03	Postage	1.29
03/07/03	Federal Express Delivery	9.01
03/07/03	Document Express Courier Service	12.37
03/07/03	Copies	3.60
03/10/03	Document Express Courier Service	135.49
03/10/03	Appeal Fee	100.00
03/10/03	Copies	1.60
03/11/03	Copies	.40
03/17/03	Appeal Fee	105.00
03/18/03	Document Express Courier Service	18.34
03/18/03	Copies	25.00
03/18/03	Postage	1.29
03/18/03	Fax	19.00
03/20/03	Copies	3.00
03/20/03	Postage	1.29
03/25/03	Fax-Long Distance	11.00
03/26/03	Fax-Local	18.00
Total expenses:		\$510.08

Jenkins & Gilchrist
A PROFESSIONAL CORPORATION

PAYMENT REMITTANCE ADDRESS:

P.O. BOX 842552
DALLAS, TEXAS 75284-2552
TAX ID #75-2204006

OFFICE LOCATIONS:

AUSTIN, TEXAS
CHICAGO, ILLINOIS
DALLAS, TEXAS
HOUSTON, TEXAS
LOS ANGELES, CALIFORNIA
SAN ANTONIO, TEXAS
NEW YORK, NEW YORK
WASHINGTON, D.C.

REMITTANCE ADVICE

April 9, 2003

ROBERT H. PETERSON COMPANY
CALIFORNIA

Invoice: 1114792
Client: 52244
Matter: 00001

Regarding: GAS BURNER FOR FIREPLACE

Fees for professional services through Mar 31, 2003	\$200.00
Expense advances through Mar 31, 2003	<u>510.08</u>
Current fees and expenses through Mar 31, 2003	\$710.08
Total balance due upon receipt	<u><u>\$710.08</u></u>

Payment of this invoice may be made by wire transfer:
BANK OF AMERICA, N.A.
ABA# 111000025
Jenkins & Gilchrist, A Professional Corporation
1445 Ross Avenue, Suite 3200, Dallas, Texas 75202-2799
Account #004772063741
Ref: Client/Matter - Name & Number

JT-APP 2653

Jenkins & Gilchrist

A PROFESSIONAL CORPORATION

PAYMENT REMITTANCE ADDRESS:

P.O. BOX 041552
DALLAS, TEXAS 75284-2552
TAX ID #75-2204006

OFFICE LOCATIONS:

AUSTIN, TEXAS
CHICAGO, ILLINOIS
DALLAS, TEXAS
HOUSTON, TEXAS
LOS ANGELES, CALIFORNIA
SAN ANTONIO, TEXAS
NEW YORK, NEW YORK
WASHINGTON, D.C.

August 20, 2003

ROBERT H. PETERSON COMPANY
CALIFORNIA

Invoice: 1153314
Client: 52244
Matter: 00001

Regarding: GAS BURNER FOR FIREPLACE

Fees for professional services through Jul 31, 2003	\$.00
Expense advances through Jul 31, 2003	<u>.00</u>
Current fees and expenses through Jul 31, 2003	\$.00
Total balance due upon receipt	<u><u>\$.00</u></u>

A description of these charges is shown on the following pages.

A copy of this page is enclosed; please return it with your payment.

For billing inquiries, please call 214-855-4051. Tax ID# 75-2204006

Jenkins & Gilchrist
A PROFESSIONAL CORPORATION

August 20, 2003

Regarding: GAS BURNER FOR FIREPLACE

Invoice: 1153314
Client: 52244
Matter: 00001

Jenkins & Gilchrist

A PROFESSIONAL CORPORATION

PAYMENT REMITTANCE ADDRESS:

P.O. BOX 842552
DALLAS, TEXAS 75284-2552
TAX ID #75-2204006

OFFICE LOCATIONS:

AUSTIN, TEXAS
CHICAGO, ILLINOIS
DALLAS, TEXAS
HOUSTON, TEXAS
LOS ANGELES, CALIFORNIA
SAN ANTONIO, TEXAS
NEW YORK, NEW YORK
WASHINGTON, D.C.

REMITTANCE ADVICE

August 20, 2003

ROBERT H. PETERSON COMPANY
CALIFORNIA

Invoice: 1153314
Client: 52244
Matter: 00001

Regarding: GAS BURNER FOR FIREPLACE

Fees for professional services through Jul 31, 2003	\$.00
Expense advances through Jul 31, 2003	<u>.00</u>
Current fees and expenses through Jul 31, 2003	\$.00
Total balance due upon receipt	<u><u>\$.00</u></u>

Payment of this invoice may be made by wire transfer:
BANK OF AMERICA, N.A.
ABA# 111000025
Jenkins & Gilchrist, A Professional Corporation
1445 Ross Avenue, Suite 3200, Dallas, Texas 75202-2799
Account #004772063741
Ref: Client/Matter - Name & Number

JT-APP 2656

Jenkins & Gilchrist
A PROFESSIONAL CORPORATION

PAYMENT REMITTANCE ADDRESS:

P.O. BOX 842552
DALLAS, TEXAS 75284-2552
TAX ID #75-2204006

OFFICE LOCATIONS:

AUSTIN, TEXAS
CHICAGO, ILLINOIS
DALLAS, TEXAS
HOUSTON, TEXAS
LOS ANGELES, CALIFORNIA
SAN ANTONIO, TEXAS
NEW YORK, NEW YORK
WASHINGTON, D.C.

May 7, 2004

ROBERT H. PETERSON COMPANY
CALIFORNIA

Invoice: 1221296
Client: 52244
Matter: 00001

Regarding: GAS BURNER FOR FIREPLACE

Fees for professional services through Apr 30, 2004	\$590.00
Expense advances through Apr 30, 2004	<u>.00</u>
Current fees and expenses through Apr 30, 2004	\$590.00
Total balance due upon receipt	<u>\$590.00</u>

A description of these charges is shown on the following pages.

A copy of this page is enclosed; please return it with your payment.

For billing inquiries, please call 214-855-4051. Tax ID# 75-2204006

JT-APP 2657

Jenkins & Gilchrist
A PROFESSIONAL CORPORATION

May 7, 2004

Invoice: 1221296

Client: 52244

Matter: 00001

Regarding: GAS BURNER FOR FIREPLACE

Description of Professional Services

04/27/04 REVIEW APPELLATE RULING.

Shareholder: Jerry Selinger

04/28/04 DETERMINE PROCEDURE FOR RETURN OF DEPOSIT TO
COURT REGISTRY; TELEPHONE CONFERENCE WITH
FINANCIAL DEPARTMENT OF CLERK'S OFFICE WITH
REFERENCE TO SAME

Counsel: Susan Powley

04/28/04 TELEPHONE CONFERENCE WITH L. HUTCHINSON
REGARDING CONTINUED INVOLVEMENT ON REMAND;
FOLLOW UP THEREON.

Shareholder: Jerry Selinger

Total fees:

\$590.00

Jenkins & Gilchrist
A PROFESSIONAL CORPORATION

PAYMENT REMITTANCE ADDRESS:

P.O. BOX 842552
DALLAS, TEXAS 75284-2552
TAX ID #75-2204006

OFFICE LOCATIONS:

AUSTIN, TEXAS
CHICAGO, ILLINOIS
DALLAS, TEXAS
HOUSTON, TEXAS
LOS ANGELES, CALIFORNIA
SAN ANTONIO, TEXAS
NEW YORK, NEW YORK
WASHINGTON, D.C.

REMITTANCE ADVICE

May 7, 2004

ROBERT H. PETERSON COMPANY
CALIFORNIA

Invoice: 1221296
Client: 52244
Matter: 00001

Regarding: GAS BURNER FOR FIREPLACE

Fees for professional services through Apr 30, 2004	\$590.00
Expense advances through Apr 30, 2004	<u>.00</u>
Current fees and expenses through Apr 30, 2004	\$590.00
Total balance due upon receipt	<u>\$590.00</u>

Payment of this invoice may be made by wire transfer:
BANK OF AMERICA, N.A.
ABA# 111000025
Jenkins & Gilchrist, A Professional Corporation
1445 Ross Avenue, Suite 3200, Dallas, Texas 75202-2799
Account #004772063741
Ref: Client/Matter - Name & Number

JT-APP 2659

Jenkins & Gilchrist
A PROFESSIONAL CORPORATION

PAYMENT REMITTANCE ADDRESS:

P.O. BOX 842552
DALLAS, TEXAS 75284-2552
TAX ID #75-2204006

OFFICE LOCATIONS:

AUSTIN, TEXAS
CHICAGO, ILLINOIS
DALLAS, TEXAS
HOUSTON, TEXAS
LOS ANGELES, CALIFORNIA
SAN ANTONIO, TEXAS
NEW YORK, NEW YORK
WASHINGTON, D.C.

June 21, 2004

ROBERT H. PETERSON COMPANY
CALIFORNIA

Invoice: 1232704
Client: 52244
Matter: 00001

Regarding: GAS BURNER FOR FIREPLACE

Fees for professional services through May 31, 2004	\$1,207.50
Expense advances through May 31, 2004	<u>18.97</u>
Current fees and expenses through May 31, 2004	\$1,226.47
Total balance due upon receipt	<u>\$1,226.47</u>

A description of these charges is shown on the following pages.

A copy of this page is enclosed; please return it with your payment.

For billing inquiries, please call 214-855-4051. Tax ID# 75-2204006

JT-APP 2660

Jenkins & Gilchrist
A PROFESSIONAL CORPORATION

June 21, 2004

Invoice: 1232704
Client: 52244
Matter: 00001

Regarding: GAS BURNER FOR FIREPLACE

Description of Professional Services

- 05/04/04 REVIEW AND COMMENT UPON DRAFT MOTION.
Shareholder: Jerry Selinger
- 05/05/04 TELEPHONE CONFERENCE WITH L. HUTCHINSON
REGARDING EDITS TO MOTION; FORWARD MOTION
FORMAT
Shareholder: Jerry Selinger
- 05/12/04 REVIEW ORDER SCHEDULING SUBMISSION OF FINDINGS
OF FACT AND CONCLUSIONS OF LAW; TRANSMIT SAME
TO L. HUTCHINSON.
Shareholder: Jerry Selinger
- 05/17/04 TELEPHONE CONFERENCE WITH D. BECKER REGARDING
MOTION FOR RETURN OF BOND.
Shareholder: Jerry Selinger
- 05/18/04 REVIEW AND REVISE MOTION FOR RETURN OF BOND;
ATTENTION TO FILING AND SERVICE OF SAME.
Shareholder: Jerry Selinger

Total fees: \$1,207.50

Jenkins & Gilchrist
A PROFESSIONAL CORPORATION

June 21, 2004

Regarding: GAS BURNER FOR FIREPLACE

Invoice: 1232704
Client: 52244
Matter: 00001

Description of Expense Advances

<u>DATE</u>	<u>DESCRIPTION</u>	<u>AMOUNT</u>
05/13/04	Copies	.20
05/18/04	Document Express Courier Service	12.37
05/18/04	Copies	6.40
Total expenses:		<hr/> \$18.97

Jenkins & Gilchrist
A PROFESSIONAL CORPORATION

PAYMENT REMITTANCE ADDRESS:

P.O. BOX 842552
DALLAS, TEXAS 75284-2552
TAX ID #75-2204006

OFFICE LOCATIONS:

AUSTIN, TEXAS
CHICAGO, ILLINOIS
DALLAS, TEXAS
HOUSTON, TEXAS
LOS ANGELES, CALIFORNIA
SAN ANTONIO, TEXAS
NEW YORK, NEW YORK
WASHINGTON, D.C.

REMITTANCE ADVICE

June 21, 2004

ROBERT H. PETERSON COMPANY
CALIFORNIA

Invoice: 1232704
Client: 52244
Matter: 00001

Regarding: GAS BURNER FOR FIREPLACE

Fees for professional services through May 31, 2004	\$1,207.50
Expense advances through May 31, 2004	<u>18.97</u>
Current fees and expenses through May 31, 2004	\$1,226.47
Total balance due upon receipt	<u>\$1,226.47</u>

Payment of this invoice may be made by wire transfer:

BANK OF AMERICA, N.A.
ABA# 111000025
Jenkins & Gilchrist, A Professional Corporation
1445 Ross Avenue, Suite 3200, Dallas, Texas 75202-2799
Account #004772063741
Ref: Client/Matter - Name & Number

JT-APP 2663

Jenkins & Gilchrist
A PROFESSIONAL CORPORATION

PAYMENT REMITTANCE ADDRESS:

P.O. BOX 842552
DALLAS, TEXAS 75284-2552
TAX ID #75-2204006

OFFICE LOCATIONS:

AUSTIN, TEXAS
CHICAGO, ILLINOIS
DALLAS, TEXAS
HOUSTON, TEXAS
LOS ANGELES, CALIFORNIA
SAN ANTONIO, TEXAS
NEW YORK, NEW YORK
WASHINGTON, D.C.

July 13, 2004

ROBERT H. PETERSON COMPANY
CALIFORNIA

Invoice: 1237915
Client: 52244
Matter: 00001

Regarding: GAS BURNER FOR FIREPLACE

Fees for professional services through Jun 30, 2004	\$1,594.00
Expense advances through Jun 30, 2004	<u>308.53</u>
Current fees and expenses through Jun 30, 2004	\$1,902.53
Total balance due upon receipt	<u>\$1,902.53</u>

A description of these charges is shown on the following pages.

A copy of this page is enclosed; please return it with your payment.

For billing inquiries, please call 214-855-4051. Tax ID# 75-2204006

JT-APP 2664

Jenkins & Gilchrist
A PROFESSIONAL CORPORATION

July 13, 2004

Invoice: 1237915
Client: 52244
Matter: 00001

Regarding: GAS BURNER FOR FIREPLACE

Description of Professional Services

- 06/08/04 TELEPHONE CONFERENCE WITH L. HUTCHINSON REGARDING REPLY BRIEF SCHEDULE AND FINDINGS OF FACT AND CONCLUSIONS OF LAW.
Shareholder: Jerry Selinger
- 06/09/04 REVIEW BRIEFING AND COURT ORDER RELATING TO RETURN OF SECURITY; TELEPHONE CONFERENCE WITH SCOTT BLACKMON (FINANCIAL OFFICER IN CLERK'S OFFICE) REGARDING SAME; DRAFT CORRESPONDENCE TO MR. BLACKMON REGARDING SAME; CONFERENCES WITH JERRY SELINGER REGARDING SAME
Counsel: Susan Powley
- 06/09/04 REVIEW AND COMMENT ON DRAFT FINDINGS AND CONCLUSIONS; ATTENTION TO COURT ORDER ALLOWING RETURN OF BOND.
Shareholder: Jerry Selinger
- 06/16/04 TELEPHONE CONFERENCE WITH COURT CLERK REGARDING CASH SECURITY RETURN; FOLLOW-UP REPORT THEREON TO L. HUTCHINSON.
Shareholder: Jerry Selinger
- 06/18/04 MESSAGE TO L. HUTCHINSON REGARDING STATUS OF RETURN OF SECURITY CHECK
Counsel: Susan Powley
- 06/23/04 RECEIVE AND REVIEW ORDER FROM COURT ADOPTING DEFENDANTS' FINDINGS OF FACT AND CONCLUSIONS OF LAW; TRANSMIT SAME TO L. HUTCHINSON.
Shareholder: Jerry Selinger

Total fees:

\$1,594.00

Jenkins & Gilchrist
A PROFESSIONAL CORPORATION

July 13, 2004

Regarding: GAS BURNER FOR FIREPLACE

Invoice: 1237915

Client: 52244

Matter: 00001

Description of Expense Advances

<u>DATE</u>	<u>DESCRIPTION</u>	<u>AMOUNT</u>
05/13/04	Overtime	25.00
06/07/04	Copies	1.60
06/08/04	Copies	.20
06/09/04	Copies	2.80
06/10/04	Document Express Courier Service	12.37
06/10/04	Copies	129.60
06/11/04	Copies	11.00
06/11/04	Fax	48.00
06/14/04	Document Express Courier Service	6.19
06/16/04	Appearance Fee	50.00
06/23/04	Copies	7.80
06/24/04	Document Express Courier Service	12.37
06/24/04	Copies	1.60
Total expenses:		\$308.53

Jenkins & Gilchrist
A PROFESSIONAL CORPORATION

PAYMENT REMITTANCE ADDRESS:

P.O. BOX 842552
DALLAS, TEXAS 75284-2552
TAX ID #75-2204006

OFFICE LOCATIONS:

AUSTIN, TEXAS
CHICAGO, ILLINOIS
DALLAS, TEXAS
HOUSTON, TEXAS
LOS ANGELES, CALIFORNIA
SAN ANTONIO, TEXAS
NEW YORK, NEW YORK
WASHINGTON, D.C.

REMITTANCE ADVICE

July 13, 2004

ROBERT H. PETERSON COMPANY
CALIFORNIA

Invoice: 1237915
Client: 52244
Matter: 00001

Regarding: GAS BURNER FOR FIREPLACE

Fees for professional services through Jun 30, 2004	\$1,594.00
Expense advances through Jun 30, 2004	<u>308.53</u>
Current fees and expenses through Jun 30, 2004	\$1,902.53
Total balance due upon receipt	<u><u>\$1,902.53</u></u>

Payment of this invoice may be made by wire transfer:

BANK OF AMERICA, N.A.
ABA# 111000025
Jenkins & Gilchrist, A Professional Corporation
1445 Ross Avenue, Suite 3200, Dallas, Texas 75202-2799
Account #004772063741
Ref: Client/Matter - Name & Number

JT-APP 2667

Attorneys' Fees Expended By Jenkens Firm

Name of Firm	Attorney Billing Rate	Total Fees For Firm
Jenkins & Gilchrist		\$24,561.50

EXHIBIT
B

JT-APP 2668

Disbursement Relating to Jenkins Firm

Type of Disbursement	Amount
Postage	\$27.75
Long distance phone	\$1.05
Photocopies	\$637.00
Travel	N/A
Express Mail Charges	\$149.18
Local Messenger Delivery	\$729.35
Paralegals	\$275.00
Computerized Legal Research	\$188.70
Facsimiles	\$231.00
TOTAL	\$1573.23



CERTIFICATE OF SERVICE

This certifies that a copy of the foregoing document was served by first-class mail, postage prepaid, to counsel for Plaintiff, William D. Harris, Jr., Schultz & Associates, P.C., 5400 LBJ Freeway, One Lincoln Center, Suite 525, Dallas, Texas 75240. and Charles Gaines, Hitt Gaines, P.C., 2435 North Central Plaza, Suite 1300, Richardson, Texas 75080, this 22nd day of July, 2004.

A handwritten signature in cursive script, reading "David Parker", is written over a horizontal line.

R

IN THE UNITED STATES DISTRICT COURT
NORTHERN DISTRICT OF TEXAS
DALLAS DIVISION

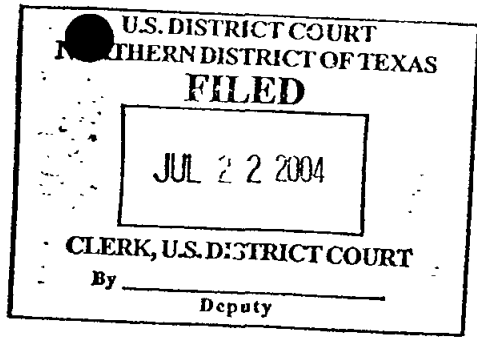

GOLDEN BLOUNT, INC.

Plaintiff,

v.

ROBERT H. PETERSON CO.

Defendant.

§
§
§
§
§
§
§
§

Civil Action No. 3-01CV0127-R

(JURY TRIAL DEMANDED)

**DECLARATION OF F. WILLIAM McLAUGHLIN IN SUPPORT OF
DEFENDANT ROBERT H. PETERSON'S APPLICATION FOR ATTORNEYS' FEES**

1. I, F. William McLaughlin, am a partner with the firm of Wood, Phillips, Katz, Clark & Mortimer and have, since the inception of the dispute, represented Robert H. Peterson Co. in the above referenced litigation.

2. My firm served as trial counsel for Robert H. Peterson and handled the initial discovery process, pre-trial briefing, trial, and post-trial motions in this case.

3. This case is a patent infringement case that presents numerous substantial and complex issues including, but not limited to, invalidity, actual infringement, contributory infringement, induced infringement, infringement under the doctrine of equivalents, willfulness, measurement of damages and the award of attorneys' fees.

4. Since the beginning of my involvement in the case, I and my colleagues have handled on behalf of our client all aspects of discovery, review and preparation of facts to be presented at trial, briefing regarding claim interpretation and pre-trial issues, trial of the case and post-trial motions prior to the appeal of the case.

5. Attached hereto as Exhibit A are true and correct copies of the Wood Phillips invoices that have been provided to Peterson representing my firm's attorneys' fees for representation in this case.

6. As the bills indicate, the vast majority of this representation was handled by me and my partner Dean A. Monco. Both Mr. Monco and I had billing rates of \$320 per hour through the end of 2002. After that time, our billings rates increased to \$340 per hour. These rates are consistent with the rates charged by my firm to other clients comparable to Peterson.

7. In total, my firm has expended \$271,839.25 in attorneys' fees in this case. Attached as Exhibit B is a brief table summarizing this information.

8. I am familiar with the customary fees for this type of litigation charged in large legal markets such as Chicago and Dallas. In my opinion, the hours billed by me and other members of my firm are reasonable in relation to the quantity and substance of the representation in this case. I further understand the hourly rates for the attorneys in my firm to be reasonable in relation to other similar attorneys in large markets such as Dallas and Chicago.

9. I have reviewed the bills and do not believe that there was significant duplication of effort among the members of my firm or the other firms representing my client.

10. It is my opinion that the total value and effort by Wood, Phillips, Katz, Clark & Mortimer was reasonable and necessary for proper defense of this case.

11. Attached as Exhibit C is a summary table indicating the disbursements and out-of-pocket expenses incurred during the course of this case.

12. In total, my firm has disbursed \$14,075.81 for postage, long distance calls, photocopying, travel, air express delivery, local messenger delivery, paralegals, computerized legal research and facsimiles.

13. In total Peterson is seeking \$285,915.06 in fees and disbursement for Wood, Phillips, Katz, Clark & Mortimer.

I declare under penalty of perjury under the laws of the United States of America that the foregoing is true and correct to the best of my knowledge and belief.

Executed July 22, 2004, at Chicago, Illinois.

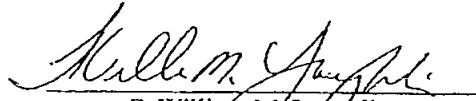
F. William McLaughlin

WOOD, PHILLIPS, VAN SANTEN, CLARK & MORTIMER

SUITE 3800
500 WEST MADISON STREET
CHICAGO, ILLINOIS 60661-2511

FEIN. 36-2121621
TELEPHONE (312) 876-1800

Robert H. Peterson Co.
2500 West Arthington Street
Chicago IL 60612-4108

Page: 1
02/28/01
Account No: 742-00008M
Statement No: 1

RE: GOLDEN BLOUNT, INC. v. ROBERT H. PERTERSON CO.

Confer with L. Bortz and review correspondence re Golden Blount. Review correspondence. Telephone conference with L. Bortz. Prepare letter to opposing counsel re waiver of service. Review Blount patent relative to Peterson prior art.

Current Services Rendered for Matter	800.00
CURRENT MONTH TOTAL	800.00
Total Matter Balance Due	\$800.00 =====

PAYMENTS RECEIVED AFTER THE DATE OF THIS INVOICE WILL APPEAR
ON YOUR NEXT BILLING STATEMENT

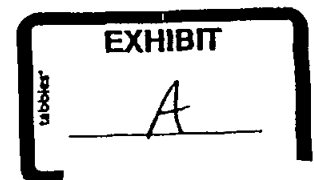

JT-APP 2674

WOOD, PHILLIPS, VAN SANTEN, CLARK & MORTIMER

SUITE 3800
500 WEST MADISON STREET
CHICAGO, ILLINOIS 60661-2511

FE.I.N. 36-2121621
TELEPHONE (312) 876-1800

Robert H. Peterson Co.
2500 West Arthington Street
Chicago IL 60612-4108

Page: 1
02/28/01
Account No: 742-99999M
Statement No: 920810

MISCELLANEOUS EXPENSES:

Photocopies	12.80
Telephone toll charges	9.50

Disbursements per Matter Thru 02/28/01	22.30
CURRENT MONTH TOTAL	22.30
Total Matter Balance Due	\$22.30
	=====

PAYMENTS RECEIVED AFTER THE DATE OF THIS INVOICE WILL APPEAR
ON YOUR NEXT BILLING STATEMENT

JT-APP 2675

WOOD, PHILLIPS, VAN SANTEN, CLARK & MORTIMER

SUITE 3800
500 WEST MADISON STREET
CHICAGO, ILLINOIS 60661-2511

F.E.I.N. 36-2121621
TELEPHONE (312) 876-1800

Robert H. Peterson Co.
2500 West Arthington Street
Chicago IL 60612-4108

Page: 1
03/31/01
Account No: 742-00008M
Statement No: 2

RE: GOLDEN BLOUNT, INC. v. ROBERT H. PERTERSON CO.

Review file histories of abandoned applications.
Review file history of Blount patent and cited references. Review complaint. Confer with possible local counsel. Confer with local counsel re answer. Review claims. Prepare answer and counterclaim. Telephone conference with L. Bortz. Prepare letters to J. Sellinger re acting as local counsel and to L. Bortz. Finalize answer. Telephone conference with L. Bortz and review drawings re prior burner configurations. Confer with local counsel. Review changes to answer. Docketing event; updating litigation docket.

Current Services Rendered for Matter	2,513.00				
CURRENT MONTH TOTAL	2,513.00				
Previous Balance	800.00				
Total Matter Balance Due	\$3,313.00 =====				
Past Due Amounts					
0-30	31-60	61-90	91-120	121-180	181+
-----	-----	-----	-----	-----	-----
2,513.00	800.00	0.00	0.00	0.00	0.00

PAYMENTS RECEIVED AFTER THE DATE OF THIS INVOICE WILL APPEAR
ON YOUR NEXT BILLING STATEMENT

JT-APP 2676

WOOD, PHILLIPS, VAN SANTEN, CLARK & MORTIMER

SUITE 3800
500 WEST MADISON STREET
CHICAGO, ILLINOIS 60661-2511

FEIN. 36-2121621
TELEPHONE (312) 876-1800

Robert H. Peterson Co.
2500 West Arthington Street
Chicago IL 60612-4108

Page: 1
03/31/01
Account No: 742-99999M
Statement No: 920811

MISCELLANEOUS EXPENSES:

Photocopies	7.00
Telecopier	23.41

Disbursements per Matter Thru 03/31/01	30.41
CURRENT MONTH TOTAL	30.41
Previous Balance	22.30
Total Matter Balance Due	\$52.71
	=====

Past Due Amounts					
0-30	31-60	61-90	91-120	121-180	181+
----	-----	-----	-----	-----	-----
30.41	22.30	0.00	0.00	0.00	0.00

PAYMENTS RECEIVED AFTER THE DATE OF THIS INVOICE WILL APPEAR
ON YOUR NEXT BILLING STATEMENT

JT-APP 2677

WOOD, PHILLIPS, VAN SANTEN, CLARK & MORTIMER

SUITE 3800
500 WEST MADISON STREET
CHICAGO, ILLINOIS 60661-2511

FEIN. 36-2121621
TELEPHONE (312) 876-1800

Robert H. Peterson Co.
2500 West Arthington Street
Chicago IL 60612-4108

Page: 1
04/30/01
Account No: 742-00008M
Statement No: 3

RE: GOLDEN BLOUNT, INC. v. ROBERT H. PERTERSON CO.

Prepare letter to L. Bortz and to opposing
counsel. Review discovery requests and forward to
L. Bortz.

Current Services Rendered for Matter	320.00
Services and disbursements provided by Jenkins & Gilchrist through March 31, 2001.	690.00
Patent Copies	162.65
Patent Copies	145.55
Telecopier	4.14

Disbursements per Matter Thru 04/30/01	1,002.34
CURRENT MONTH TOTAL	1,322.34
Total Matter Balance Due	\$1,322.34
	=====

		Past Due Amounts				
0-30	31-60	61-90	91-120	121-180	181+	
----	----	----	-----	-----	----	
3,835.34	0.00	0.00	0.00	0.00	0.00	

PAYMENTS RECEIVED AFTER THE DATE OF THIS INVOICE WILL APPEAR
ON YOUR NEXT BILLING STATEMENT

JT-APP 2678

WOOD, PHILLIPS, VAN SANTEN, CLARK & MORTIMER

SUITE 3800
500 WEST MADISON STREET
CHICAGO, ILLINOIS 60661-2511

FEIN. 36-2121621
TELEPHONE (312) 876-1800

Robert H. Peterson Co.
2500 West Arthington Street
Chicago IL 60612-4108

Page: 1
04/30/01
Account No: 742-99999M
Statement No: 920812

MISCELLANEOUS EXPENSES:

Photocopies	10.60
Disbursements per Matter Thru 04/30/01	10.60
CURRENT MONTH TOTAL	10.60

Total Matter Balance Due	\$10.60
	=====

Past Due Amounts					
0-30	31-60	61-90	91-120	121-180	181+
----	----	----	----	-----	----
41.01	0.00	0.00	0.00	0.00	0.00

PAYMENTS RECEIVED AFTER THE DATE OF THIS INVOICE WILL APPEAR
ON YOUR NEXT BILLING STATEMENT

JT-APP 2679

WOOD, PHILLIPS, VAN SANTEN, CLARK & MORTIMER

SUITE 3800
500 WEST MADISON STREET
CHICAGO, ILLINOIS 60661-2511

FE.I.N. 36-2121621
TELEPHONE (312) 876-1800

Robert H. Peterson Co.
2500 West Arthington Street
Chicago IL 60612-4108

Page: 1
05/31/01
Account No: 742-00008M
Statement No: 4

RE: GOLDEN BLOUNT, INC. v. ROBERT H. PERTERSON CO.

Prepare draft discovery requests. Revise discovery requests. Forward discovery requests to J. Sellinger. Telephone conference with L. Bortz. Outline initial responses to discovery requests. Prepare for and confer by telephone with L. Bortz re discovery responses. Begin drafting replies to discovery requests. Telephone conference and office conference with L. Bortz. Continue preparation of discovery responses. Confer with local counsel. Prepare letter to opposing counsel re joint status report. Review draft joint status report. Revise and forward to opposing counsel. Finalize discovery responses. Confer with local counsel. Revises interrogatories. Prepare letter to L. Bortz. Confer with local counsel re interrogatories. Review and finalize revised interrogatories. Prepare letter to L. Bortz re discovery.

Current Services Rendered for Matter	5,760.00
Federal Express shipment to Dallas TX on 5/7/01	21.53
Photocopies	26.60
Telephone toll charges	1.80
Telecopier	17.25
Postage	2.99

Disbursements per Matter Thru 05/31/01	70.17
CURRENT MONTH TOTAL	5,830.17
Total Matter Balance Due	\$5,830.17 =====

PAYMENTS RECEIVED AFTER THE DATE OF THIS INVOICE WILL APPEAR
ON YOUR NEXT BILLING STATEMENT

JT-APP 2680

WOOD, PHILLIPS, VAN SANTEN, CLARK & MORTIMER

SUITE 3800
500 WEST MADISON STREET
CHICAGO, ILLINOIS 60661-2511

FEIN. 36-2121621
TELEPHONE (312) 876-1800

Robert H. Peterson Co.
2500 West Arthington Street
Chicago IL 60612-4108

Page: 1
06/30/01
Account No: 742-00008M
Statement No: 5

RE: GOLDEN BLOUNT, INC. v. ROBERT H. PETERSON CO.

	Hours	
06/06/01		
FWM Review documents for production. Confer with DAM re protective order.	2.00	
DAM Reviewing proposed Protective Order; Conferring with FWM.	.50	
06/13/01		
FWM Confer with and prepare letter to R. Hardin re prior use.	.50	
06/14/01		
FWM Revise letter and prepare exhibits. Confer with L. Bortz.	.50	
06/18/01		
DAM Reviewing proposed Protective Order; conferring with opposing counsel re: same.	1.00	
06/28/01		
FWM Review Blount's discovery responses. Prepare letter to L. Bortz.	.50	
06/29/01		
DAM Conferring with opposing counsel re: settlement.	.25	

Current Services Rendered for Matter	5.25	1,580.00

Recapitulation			
Attorney	Hours	Hourly Rate	Total
-----	-----	-----	-----
F.W. McLaughlin	3.50	\$320.00	\$1,120.00
D.A. Monco	1.75	320.00	560.00

Disbursements and fees to Jenkins & Gilchrist for professional services through May 31, 2001. 1,581.25

WOOD, PHILLIPS, VAN SANTEN, CLARK & MORTIMER

SUITE 3800
500 WEST MADISON STREET
CHICAGO, ILLINOIS 60661-2511

FE.I.N. 36-2121621
TELEPHONE (312) 876-1800

Robert H. Peterson Co.

Page: 2

06/30/01

Account No: 742-00008M

Statement No: 5

RE: GOLDEN BLOUNT, INC. v. ROBERT H. PETERSON CO.

Disbursements per Matter Thru 06/30/01	----- 1,581.26
CURRENT MONTH TOTAL	3,261.26
Total Matter Balance Due	\$3,261.26 =====

Past Due Amounts					
0-30	31-60	61-90	91-120	121-180	181+
----- 9,091.43	----- 0.00	----- 0.00	----- 0.00	----- 0.00	----- 0.00

PAYMENTS RECEIVED AFTER THE DATE OF THIS INVOICE WILL APPEAR
ON YOUR NEXT BILLING STATEMENT

JT-APP 2682

WOOD, PHILLIPS, VAN SANTEN, CLARK & MORTIMER

SUITE 3800
500 WEST MADISON STREET
CHICAGO, ILLINOIS 60661-2511

FE.I.N. 36-2121621
TELEPHONE (312) 876-1800

Robert H. Peterson Co.

Page: 2
06/30/01
Account No: 742-00008M
Statement No: 5

RE: GOLDEN BLOUNT, INC. v. ROBERT H. PETERSON CO.

Disbursements per Matter Thru 06/30/01	1,581.26
CURRENT MONTH TOTAL	3,261.26
Total Matter Balance Due	\$3,261.26
	=====

Past Due Amounts					
0-30	31-60	61-90	91-120	121-180	181+
----	----	----	----	-----	----
9,091.43	0.00	0.00	0.00	0.00	0.00

PAYMENTS RECEIVED AFTER THE DATE OF THIS INVOICE WILL APPEAR
ON YOUR NEXT BILLING STATEMENT

JT-APP 2683

WOOD, PHILLIPS, VAN SANTEN, CLARK & MORTIMER

SUITE 3800
500 WEST MADISON STREET
CHICAGO, ILLINOIS 60661-2511

EELN. 36-2121621
TELEPHONE (312) 876-1800

Robert H. Peterson Co.
2500 West Arthington Street
Chicago IL 60612-4108

Page: 1
06/30/01
Account No: 742-99999M
Statement No: 920814

MISCELLANEOUS EXPENSES:

Photocopies	31.60
Telephone toll charges	3.04
Postage	1.39

Disbursements per Matter Thru 06/30/01	36.03
CURRENT MONTH TOTAL	36.03
Total Matter Balance Due	\$36.03
	=====

PAYMENTS RECEIVED AFTER THE DATE OF THIS INVOICE WILL APPEAR
ON YOUR NEXT BILLING STATEMENT

JT-APP 2684

WOOD, PHILLIPS, VAN SANTEN, CLARK & MORTIMER

SUITE 3800
500 WEST MADISON STREET
CHICAGO, ILLINOIS 60661-2511

FEIN. 36-2121621
TELEPHONE (312) 876-1800

Robert H. Peterson Co.
2500 West Arthington Street
Chicago IL 60612-4108

Page: 1
07/31/01
Account No: 742-00008M
Statement No: 6

RE: GOLDEN BLOUNT, INC. v. ROBERT H. PETERSON CO.

	Hours	
07/02/01		
CDW Docketing entries, including Interrogatory Requests and Responses, Discovery Requests, Status Report, and Plaintiff's Answers.	.95	
DAM Conferring with opposing counsel re: settlement.	.50	
07/05/01		
FWM Prepare documents for production. Telephone conference with L. Bortz.	1.25	
07/24/01		
FWM Confer with opposing counsel re settlement.	.50	
07/25/01		
FWM Review claims and prior art. Confer with D. Monco re discovery. Telephone conferences with L. Bortz and opposing counsel.	1.75	
07/30/01		
DAM Reviewing file histories and cited references for patent-in-suit; reviewing correspondence and attachments from FWM to opposing counsel.	3.00	
07/31/01		
FWM Telephone conferences with opposing counsel and T. Corrin re discovery.	.75	
DAM Conferring with opposing counsel re: discovery; conferring with FWM.	.50	
	-----	-----
Current Services Rendered for Matter	10.65	2,790.00

JT-APP 2685

WOOD, PHILLIPS, VAN SANTEN, CLARK & MORTIMER

SUITE 3800
500 WEST MADISON STREET
CHICAGO, ILLINOIS 60661-2511

FE.I.N. 36-2121621
TELEPHONE (312) 876-1800

Robert H. Peterson Co.

Page: 2

07/31/01

Account No: 742-00008M

Statement No: 6

RE: GOLDEN BLOUNT, INC. v. ROBERT H. PETERSON CO.

Recapitulation

Attorney	Hours	Hourly Rate	Total
F.W. McLaughlin	4.25	\$320.00	\$1,360.00
D.A. Monco	4.00	320.00	1,280.00
Chris D. Wood	2.40	62.50	150.00

Associates services and disbursements re:
receiving protective order entered by court;
transmit same to client. 180.00

Disbursements per Matter Thru 07/31/01 180.00

CURRENT MONTH TOTAL 2,970.00

Total Matter Balance Due \$2,970.00

Past Due Amounts					
0-30	31-60	61-90	91-120	121-180	181+
2,970.00	3,261.26	0.00	0.00	0.00	0.00

PAYMENTS RECEIVED AFTER THE DATE OF THIS INVOICE WILL APPEAR
ON YOUR NEXT BILLING STATEMENT

WOOD, PHILLIPS, VAN SANTEN, CLARK & MORTIMER

SUITE 3800
500 WEST MADISON STREET
CHICAGO, ILLINOIS 60661-2511

FE.I.N. 36-2121621
TELEPHONE (312) 876-1800

Robert H. Peterson Co.
2500 West Arthington Street
Chicago IL 60612-4108

Page: 1
08/31/01
Account No: 742-00008M
Statement No: 7

RE: GOLDEN BLOUNT, INC. v. ROBERT H. PETERSON CO.

	Hours	
08/30/01		
CDW Litigation/docket schedule.	.25	
08/31/01		
FWM Confer with opposing counsel re discovery.	.50	
Current Services Rendered for Matter	.75	191.25

Recapitulation			
Attorney	Hours	Hourly Rate	Total

F.W. McLaughlin	0.50	\$320.00	\$160.00
Chris D. Wood	0.25	125.00	31.25

Services and disbursements provided by Jenkens & Gilchrist re: attempted telephone conference with FWM regarding pleading amendment deadline and deadline for Defendent to designate experts;	90.00
Email communication to FWM regarding same.	3.75
Telecopier	-----
Disbursements per Matter Thru 08/31/01	93.75
CURRENT MONTH TOTAL	285.00
Total Matter Balance Due	\$285.00
	=====

PAYMENTS RECEIVED AFTER THE DATE OF THIS INVOICE WILL APPEAR
ON YOUR NEXT BILLING STATEMENT

JT-APP 2687

WOOD, PHILLIPS, VAN SANTEN, CLARK & MORTIMER

SUITE 3800
500 WEST MADISON STREET
CHICAGO, ILLINOIS 60661-2511

FEIN. 36-2121621
TELEPHONE (312) 876-1800

Robert H. Peterson Co.
14724 Proctor Ave
City of Industry CA 91746-3202

Page: 1
09/30/01
Account No: 742-00008M
Statement No: 8

RE: GOLDEN BLOUNT, INC. v. ROBERT H. PETERSON CO.

09/20/01

FWM Confer with and forward documents to opposing counsel.

09/26/01

FWM Initial review of produced documents. Review pending schedule.

09/27/01

FWM Confer with opposing counsel re discovery.
Confer with DAM re pending matters.
DAM Conferring with FWM re: strategy for depositions.

09/28/01

FWM Review correspondence from opposing counsel re subjects of deposition. Review documents.
Review Notices of Deposition. Prepare letter to opposing counsel.

FWM delete

CDW Docketing event; updating, printing and cc'ing litigation docket to attorneys of record.

Current Services Rendered for Matter 2,187.50

Local Counsels services re telephone conference with Bill McLaughlin regarding extension of time; telephone conference with Bill Harris regarding thirty-day extension.

180.00

Federal Express shipment to Richardson, TX on 9/20/01.

6.92

Disbursements per Matter Thru 09/30/01

186.92

CURRENT MONTH TOTAL

2,374.42

WOOD, PHILLIPS, VAN SANTEN, CLARK & MORTIMER

SUITE 3800
500 WEST MADISON STREET
CHICAGO, ILLINOIS 60661-2511

FE.I.N. 36-2121621
TELEPHONE (312) 876-1800

Robert H. Peterson Co.

Page: 2
09/30/01
Account No: 742-00008M
Statement No: 8

RE: GOLDEN BLOUNT, INC. v. ROBERT H. PETERSON CO.

Total Matter Balance Due \$2,374.42
=====

Past Due Amounts					
0-30	31-60	61-90	91-120	121-180	181+
----	----	----	-----	-----	-----
2,659.42	0.00	0.00	0.00	0.00	0.00

PAYMENTS RECEIVED AFTER THE DATE OF THIS INVOICE WILL APPEAR
ON YOUR NEXT BILLING STATEMENT

JT-APP 2689

WOOD, PHILLIPS, VAN SANTEN, CLARK & MORTIMER

SUITE 3800
500 WEST MADISON STREET
CHICAGO, ILLINOIS 60661-2511

FEIN. 36-2121621
TELEPHONE (312) 876-1800

Robert H. Peterson Co.
14724 Proctor Ave
City of Industry CA 91746-3202

Page: 1
09/30/01
Account No: 742-99999M
Statement No: 920816

MISCELLANEOUS EXPENSES:

Photocopies	7.20
Telephone toll charges	2.87

Disbursements per Matter Thru 09/30/01	10.07
CURRENT MONTH TOTAL	10.07
Total Matter Balance Due	\$10.07
	=====

PAYMENTS RECEIVED AFTER THE DATE OF THIS INVOICE WILL APPEAR
ON YOUR NEXT BILLING STATEMENT

JT-APP 2690

WOOD, PHILLIPS, VAN SANTEN, CLARK & MORTIMER

SUITE 3800
500 WEST MADISON STREET
CHICAGO, ILLINOIS 60661-2511

FEIN. 36-2121621
TELEPHONE (312) 876-1800

Robert H. Peterson Co.
14724 Proctor Ave
City of Industry CA 91746-3202

Page: 1
10/31/01
Account No: 742-00008M
Statement No: 9

RE: GOLDEN BLOUNT, INC. v. ROBERT H. PETERSON CO.

10/01/01

FWM Confer with L. Bortz and opposing counsel re scheduling deposition. Review RHP documents. Forward documents to L. Bortz. Confer with L. Bortz and DAM re U burner.
DAM Reviewing patent file history; conferring with Leslie Bortz; conferring with F.W. McLaughlin re: strategy; reviewing pleadings.

10/02/01

CDW Docketing numerous events; updating litigation docket.
FWM Review amended deposition notice. Prepare letter to opposing counsel. Telephone conference with L. Bortz.

10/03/01

DAM Reviewing patent in suit; reviewing prior art; conferring with F.W. McLaughlin.

10/04/01

FWM Review documents and assemble information in advance of deposition. Telephone conference with L. Bortz.
DAM Preparing for deposition.

10/05/01

FWM Conference with L. Bortz and DAM prior to deposition. Confer with L. Bortz and DAM during deposition.
DAM Attending deposition of Leslie Bortz; conferring with counsel.

10/08/01

FWM Confer with DAM re deposition. Review memo summarizing issues raised in deposition. Prepare letter to L. Bortz.
DAM Preparing and revising memorandum to F.W.

JT-APP 2691

WOOD, PHILLIPS, VAN SANTEN, CLARK & MORTIMER

SUITE 3800
500 WEST MADISON STREET
CHICAGO, ILLINOIS 60661-2511

FEIN. 36-2121621
TELEPHONE (312) 876-1800

Robert H. Peterson Co.

Page: 2
10/31/01
Account No: 742-00008M
Statement No: 9

RE: GOLDEN BLOUNT, INC. v. ROBERT H. PETERSON CO.

McLaughlin; conferring with F.W. McLaughlin.

10/09/01

- CDW Two docketing events; updating litigation schedule; copying and cc'ing court papers and updated litigation schedule.
- FWM Telephone conference with L. Bortz and prepare letter re issues from deposition. Confer with DAM.
- DAM Revising draft letter to Leslie Bortz; conferring with F.W. McLaughlin re: strategy and Motion for Summary Judgment.

10/10/01

- FWM Telephone conference with W. Harris and confer with DAM re motion on advice of counsel. Confer with local counsel re motion and prepare letter to W. Harris. Telephone conference with L. Bortz and DAM to discuss deposition and summary judgment. Forward exhibits to and confer by telephone with D, Dworkin.
- DAM Conferring with F.W. McLaughlin re: strategy, including Summary Judgment; conferring with Leslie Bortz re: strategy; reviewing correspondence to Leslie Bortz and opposing counsel.

10/11/01

- FWM Confer with DAM.

10/12/01

- FWM Telephone conference with J. Palaski. Prepare declarations of Darryl Dworkin and J. Palaski.

10/15/01

- FWM Initial review of deposition transcript. Review motion in limine.
- CDW docketing event.

10/16/01

- FWM Assemble G4 burner with Ember Flame Booster. Review fax from J. Palaski and confer by telephone with J. Palaski.

WOOD, PHILLIPS, VAN SANTEN, CLARK & MORTIMER

SUITE 3800
500 WEST MADISON STREET
CHICAGO, ILLINOIS 60661-2511

FEIN. 36-2121621
TELEPHONE (312) 876-1800

Robert H. Peterson Co.

Page: 3
10/31/01
Account No: 742-0008M
Statement No: 9

RE: GOLDEN BLOUNT, INC. v. ROBERT H. PETERSON CO.

10/17/01

FWM Review fax from and confer by telephone with D. Dworkin re declaration. Revise declarations and forward for signature. Prepare draft reply brief to motion in limine. Report to L. Bortz.
CDW Printing and cc'ing litigation docket.

10/18/01

CDW Docketing event.
FWM Finalize declarations.

10/23/01

CDW Docketing event.
CDW Updating, printing and cc'ing litigation docket.
FWM Revise brief.

10/24/01

FWM Confer with DAM re brief.
DAM Revising opposition brief to Motion to Exclude Attorney Opinion.

10/26/01

FWM Telephone conference with L. Bortz. Review deposition transcript. Prepare letter to L. Bortz.

10/29/01

FWM Finalize brief.

10/30/01

FWM Prepare letter to W. Harris forwarding declarations. Prepare letter to local counsel forwarding brief.

10/31/01

FWM Confer with local counsel re brief.
CDW Docketing events; printing and cc'ing litigation docket.

Current Services Rendered for Matter

15,581.00

Copy transcript
Telecopier

713.09
24.64

JT-APP 2693

WOOD, PHILLIPS, VAN SANTEN, CLARK & MORTIMER

SUITE 3800
500 WEST MADISON STREET
CHICAGO, ILLINOIS 60661-2511

EELN. 36-2121621
TELEPHONE (312) 876-1800

Robert H. Peterson Co.

Page: 4
10/31/01
Account No: 742-00008M
Statement No: 9

RE: GOLDEN BLOUNT, INC. v. ROBERT H. PETERSON CO.

Disbursements per Matter Thru 10/31/01 737.73

CURRENT MONTH TOTAL 16,318.73

Total Matter Balance Due \$16,318.73
=====

Past Due Amounts					
0-30	31-60	61-90	91-120	121-180	181+
-----	-----	-----	-----	-----	-----
16,318.73	2,374.42	0.00	0.00	0.00	0.00

PAYMENTS RECEIVED AFTER THE DATE OF THIS INVOICE WILL APPEAR
ON YOUR NEXT BILLING STATEMENT

JT-APP 2694

WOOD, PHILLIPS, VAN SANTEN, CLARK & MORTIMER

SUITE 3800
500 WEST MADISON STREET
CHICAGO, ILLINOIS 60661-2511

FEIN. 36-2121621
TELEPHONE (312) 876-1800

Robert H. Peterson Co.
14724 Proctor Ave
City of Industry CA 91746-3202

Page: 1
10/31/01
Account No: 742-99999M
Statement No: 920817

MISCELLANEOUS EXPENSES:

Photocopies	28.60
Telephone toll charges	6.76
Telecopier	1.68
Postage	6.45

Disbursements per Matter Thru 10/31/01 43.49

CURRENT MONTH TOTAL 43.49

Total Matter Balance Due \$43.49
=====

Past Due Amounts					
0-30	31-60	61-90	91-120	121-180	181+
43.49	10.07	0.00	0.00	0.00	0.00

PAYMENTS RECEIVED AFTER THE DATE OF THIS INVOICE WILL APPEAR
ON YOUR NEXT BILLING STATEMENT

JT-APP 2695

WOOD, PHILLIPS, VAN SANTEN, CLARK & MORTIMER

SUITE 3800
500 WEST MADISON STREET
CHICAGO, ILLINOIS 60661-2511

FEELN. 36-2121621
TELEPHONE (312) 876-1800

Robert H. Peterson Co.
14724 Proctor Ave
City of Industry CA 91746-3202

Page: 1
11/30/01
Account No: 742-00008M
Statement No: 10

RE: GOLDEN BLOUNT, INC. v. ROBERT H. PETERSON CO.

- 11/02/01
FWM Telephone conference with W. Harris re extending date for pretrial disclosures.
- 11/05/01
FWM Review letter from W. Harris re extension of pretrial disclosures. Prepare reply.
FWM Telephone conference with L. Bortz re deposition transcript.
- 11/06/01
FWM Telephone conference with W. Harris.
- 11/07/01
FWM Telephone conferences with W. Harris and L. Bortz re settlement discussions.
- 11/13/01
FWM Review Blount's reply on motion in limine. Telephone conferences with opposing counsel, local counsel and magistrate's clerk re hearing on motion.
- 11/19/01
FWM Review order rescheduling hearing. Confer with local counsel.
- 11/27/01
FWM Telephone conference with local counsel re hearing. Review order on motion in limine. Telephone report to L. Bortz.
- 11/28/01
CDW Docketing of pleadings and due dates.
- 11/30/01
FWM Assemble documents for production re advice of

JT-APP 2696

WOOD, PHILLIPS, VAN SANTEN, CLARK & MORTIMER

SUITE 3800
500 WEST MADISON STREET
CHICAGO, ILLINOIS 60661-2511

FEIN. 36-2121621
TELEPHONE (312) 876-1800

Robert H. Peterson Co.

Page: 2

11/30/01

Account No: 742-00008M

Statement No: 10

RE: GOLDEN BLOUNT, INC. v. ROBERT H. PETERSON CO.

counsel. Confer with local counsel.

Current Services Rendered for Matter	1,750.00
Services provided for September 2001 by Jenkins & Gilchrist	510.00
Associates services and disbursements re above case for the month of October 2001.	315.00
Federal Express shipment to Dallas TX on 10/30/01	10.48
Telecopier	12.44

Disbursements per Matter Thru 11/30/01	847.92
CURRENT MONTH TOTAL	2,597.92
Total Matter Balance Due	\$2,597.92
	=====

Past Due Amounts						
0-30	31-60	61-90	91-120	121-180	181+	
----	----	----	----	-----	-----	----
18,916.65	0.00	0.00	0.00	0.00	0.00	

PAYMENTS RECEIVED AFTER THE DATE OF THIS INVOICE WILL APPEAR
ON YOUR NEXT BILLING STATEMENT

JT-APP 2697

WOOD, PHILLIPS, VAN SANTEN, CLARK & MORTIMER

SUITE 3800
500 WEST MADISON STREET
CHICAGO, ILLINOIS 60661-2511

E.E.I.N. 36-2121621
TELEPHONE (312) 876-1800

Robert H. Peterson Co.
14724 Proctor Ave
City of Industry CA 91746-3202

Page: 1
11/30/01
Account No: 742-99999M
Statement No: 920818

MISCELLANEOUS EXPENSES:

Photocopies	10.20
Telephone toll charges	1.01

Disbursements per Matter Thru 11/30/01	11.21
CURRENT MONTH TOTAL	11.21
Total Matter Balance Due	\$11.21
	=====

Past Due Amounts					
0-30	31-60	61-90	91-120	121-180	181+
----	-----	-----	-----	-----	-----
54.70	0.00	0.00	0.00	0.00	0.00

PAYMENTS RECEIVED AFTER THE DATE OF THIS INVOICE WILL APPEAR
ON YOUR NEXT BILLING STATEMENT

JT-APP 2698

WOOD, PHILLIPS, VAN SANTEN, CLARK & MORTIMER

SUITE 3800
500 WEST MADISON STREET
CHICAGO, ILLINOIS 60661-2511

FEIN. 36-2121621
TELEPHONE (312) 876-1800

Robert H. Peterson Co.
14724 Proctor Ave
City of Industry CA 91746-3202

Page:
12/31/0
Account No: 742-000081
Statement No: 1:

RE: GOLDEN BLOUNT, INC. v. ROBERT H. PETERSON CO.

12/05/01

FWM Telephone conferences with W. Harris and L. Bortz
re depositions.

12/06/01

FWM Telephone conferences with L. Bortz and J.
Sellinger.

12/10/01

CDW Litigation docket.

12/13/01

FWM Confering with L. Bortz, local counsel and
opposing counsel re deposition.

12/14/01

FWM Confer with L. Bortz and prepare letter re
deposition.

12/17/01

FWM Review documents in preparation for deposition.
Confer with local counsel re scope of deposition.

12/18/01

FWM Prepare for deposition.
DAM Confering with F. William McLaughlin re:
depositions in Dallas.

12/19/01

FWM Attend deposition in Dallas.

12/20/01

FWM Review materials from deposition. Confer with S.
Powley.
DAM Confering with F. William McLaughlin re:
depositions in Dallas and status.

WOOD, PHILLIPS, VAN SANTEN, CLARK & MORTIMER

SUITE 3800
500 WEST MADISON STREET
CHICAGO, ILLINOIS 60661-2511

FEIN. 36-2121621
TELEPHONE (312) 876-1800

Robert H. Peterson Co.

Account No: 742-000081
Statement No: 1

Page:
12/31/01

RE: GOLDEN BLOUNT, INC. v. ROBERT H. PETERSON CO.

12/26/01

FWM Review documents. Prepare letter to W. Harris forwarding documents.

12/27/01

FWM Prepare letter to W. Harris re witnesses.

Current Services Rendered for Matter	5,618.79
Professional services provided by Jenkins & Gilchrist for the month of November 2001.	1,188.86
Travel Expenses of trip to Dallas, TX on 12/19/01.	806.30

Disbursements per Matter Thru 12/31/01	1,995.16
CURRENT MONTH TOTAL	7,613.91
Total Matter Balance Due	\$7,613.91
	=====

Past Due Amounts					
0-30	31-60	61-90	91-120	121-180	181+
----	-----	-----	-----	-----	-----
7,613.91	2,597.92	16,318.73	0.00	0.00	0.00

PAYMENTS RECEIVED AFTER THE DATE OF THIS INVOICE WILL APPEAR
ON YOUR NEXT BILLING STATEMENT

JT-APP 2700

WOOD, PHILLIPS, VAN SANTEN, CLARK & MORTIMER

SUITE 3800
500 WEST MADISON STREET
CHICAGO, ILLINOIS 60661-2511

F.E.I.N. 36-2121621
TELEPHONE (312) 876-1800

Robert H. Peterson Co.
14724 Proctor Ave
City of Industry CA 91746-3202

Page: 12/31/01
Account No: 742-99999
Statement No: 92081

MISCELLANEOUS EXPENSES:

Photocopies	16.8
Telephone toll charges	4.6
Postage	6.4

Disbursements per Matter Thru 12/31/01	27.9
CURRENT MONTH TOTAL	27.9
Total Matter Balance Due	\$27.90
	=====

Past Due Amounts					
0-30	31-60	61-90	91-120	121-180	181+
----	-----	-----	-----	-----	-----
27.90	11.21	43.49	0.00	0.00	0.00

PAYMENTS RECEIVED AFTER THE DATE OF THIS INVOICE WILL APPEAR
ON YOUR NEXT BILLING STATEMENT

JT-APP 2701

WOOD, PHILLIPS, VAN SANTEN, CLARK & MORTIMER

SUITE 3800
500 WEST MADISON STREET
CHICAGO, ILLINOIS 60661-2511

FE.IN. 36-2121621
TELEPHONE (312) 876-1800

Robert H. Peterson Co.
14724 Proctor Ave
City of Industry CA 91746-3202

Page: 1
01/31/02
Account No: 742-00008M
Statement No: 12

RE: GOLDEN BLOUNT, INC. v. ROBERT H. PETERSON CO.

01/07/02

CDW Docketing events.

01/08/02

FWM Receive and scan deposition transcripts.
Telephone conference with court reporter. Confer
with L. Bortz re settlement and trial
preparation. Confer with DAM re trial
preparation.

01/09/02

FWM Review transcript of L. Bortz deposition.

01/10/02

FWM Review transcript from my deposition. Confer
with local counsel re pretrial order and
settlement.
DAM Conferring with F. William McLaughlin re: status.

01/11/02

FWM Prepare letter to L. Bortz.
DAM Conferring with F. William McLaughlin; reviewing
letter to client re: expenses of case.

01/14/02

FWM Confer with opposing counsel re scheduling for
pretrial order preparation.
DAM Conferring with F. William McLaughlin re: status.

01/15/02

FWM Begin preparation of exhibit list.

01/17/02

FWM Correspond with B. Harris. Compare burner to
claims with DAM.

01/18/02

FWM Telephone conference with L. Bortz re witnesses.

JT-APP 2702

WOOD, PHILLIPS, VAN SANTEN, CLARK & MORTIMER

SUITE 3800
500 WEST MADISON STREET
CHICAGO, ILLINOIS 60661-2511

FE.I.N. 36-2121621
TELEPHONE (312) 876-1800

Robert H. Peterson Co.

Page: 2

01/31/02

Account No: 742-00008M

Statement No: 12

RE: GOLDEN BLOUNT, INC. v. ROBERT H. PETERSON CO.

Prepare letter to local counsel. Revise exhibit list.

01/22/02

FWM Confer with L. Bortz and local counsel. Finalize witness list and exhibit list. Initial review of Blount's witness list and exhibit list.

01/25/02

FWM Confer with W. Harris re pretrial order.

01/28/02

FWM Confer with JLC re preparation of jury instructions.
DAM Reviewing Golden Blount documents and preparing objections to exhibits.
JLC Conference with FWM regarding jury instructions for pretrial order; review misc. portions of file re same; misc. legal research re specific issues in case, including oral attorney opinion; telephone conference with local counsel office regarding local requirements for instructions; begin drafting jury instructions;

01/29/02

FWM Review documents from Blount.
DAM Reviewing Peterson production documents.
JLC Continued legal research and drafting of jury instructions;

01/30/02

FWM Confer with DAM re exhibits and witnesses.
JLC Continued legal research and drafting of jury instructions;
DAM Completing objections to Plaintiff's exhibits; reviewing file, including patent in suit and prior art and file histories.

Current Services Rendered for Matter

13,517.50

Services provided by Jenkins & Gilchrist for the month of December 2001.

4,515.00

Federal Express shipment to Dallas TX on 12/17/01

11.57

JT-APP 2703

WOOD, PHILLIPS, VAN SANTEN, CLARK & MORTIMER

SUITE 3800
500 WEST MADISON STREET
CHICAGO, ILLINOIS 60661-2511

FEIN. 36-2121621
TELEPHONE (312) 876-1800

Robert H. Peterson Co. Page: 3
01/31/02
Account No: 742-00008M
Statement No: 12
RE: GOLDEN BLOUNT, INC. v. ROBERT H. PETERSON CO.

Telecopier	7.76

Disbursements per Matter Thru 01/31/02	4,534.33
CURRENT MONTH TOTAL	18,051.83
Previous Balance	26,530.56
Total Matter Balance Due	\$44,582.39 =====

Past Due Amounts					
0-30	31-60	61-90	91-120	121-180	181+
----	-----	-----	-----	-----	-----
18,051.83	7,613.91	2,597.92	16,318.73	0.00	0.00

PAYMENTS RECEIVED AFTER THE DATE OF THIS INVOICE WILL APPEAR
ON YOUR NEXT BILLING STATEMENT

JT-APP 2704

WOOD, PHILLIPS, VAN SANTEN, CLARK & MORTIMER

SUITE 3800
500 WEST MADISON STREET
CHICAGO, ILLINOIS 60661-2511

FE.I.N. 36-2121621
TELEPHONE (312) 876-1800

Robert H. Peterson Co.
2500 W. Arthington
Chicago IL 60612

Page: 1
02/28/02
Account No: 742-00008M
Statement No: 13

Attn: Leslie Bortz

RE: GOLDEN BLOUNT, INC. v. ROBERT H. PETERSON CO.

- 02/01/02 FWM Review proposed stipulation. Telephone conference with L. Bortz. Complete review of deposition transcript.
DAM Conferring with FWM re: pre-trial issues.
- 02/04/02 FWM Review initial draft of plaintiff's proposed pretrial order. Review files re privilege log.
CDW litigation docket.
JLC Misc. services relating to preparation of jury instructions for trial, including legal research re instructions and law and drafting misc. general jury instructions;
- 02/05/02 FWM Telephone conference with L. Bortz. Review proposed stipulated facts. Analyze burner dimensions relative to proposed stipulations and claims. Prepare letter to W. Harris.
DAM Preparing Voir Dire Questions.
- 02/06/02 CDW Docketing event;
FWM Prepare summary of claims and defenses for pretrial order.
Review voir dire questions. Confer with JLC re jury instructions.
JLC Continued preparation of jury instructions for trial, including legal research re instructions and law, review misc. materials received from opposing counsel relating to issues in case, and drafting misc. jury instructions;
DAM Preparing elements of Final Pre-Trial Order.
- 02/07/02 FWM Confer with DAM re trial witnesses and jury instructions. Update witness list to include explanation of expected testimony. Prepare letter to W. Harris re pretrial order.
Review stipulations and prepare draft revisions.
Telephone conference with L. Bortz.
JLC Continued preparation of jury instructions for trial, including legal research re instructions and law, misc. conferences with FWM and DAM relating to issues in case, and continued drafting of misc. jury instructions;
DAM Preparing and revising elements of final Pre-Trial Order; conferring with FWM re: strategy.
- 02/08/02 JLC Continued drafting and organizing of jury instructions for trial, including analysis
re full issues to cover with full
set of instructions, legal research re misc. issues, and conferences with FWM and DAM relating to issues in case;

JT-APP 2705

WOOD, PHILLIPS, VAN SANTEN, CLARK & MORTIMER

SUITE 3800
500 WEST MADISON STREET
CHICAGO, ILLINOIS 60661-2511

FE.I.N. 36-2121621
TELEPHONE (312) 876-1800

Robert H. Peterson Co.

Page: 2
02/28/02

Account No: 742-00008M
Statement No: 13

RE: GOLDEN BLOUNT, INC. v. ROBERT H. PETERSON CO.

FWM Review and revise statement of contested facts and issues.
Confer with DAM re witnesses. Prepare letter to W. Harris
re additions to pre-trial order.
DAM Preparing and revising elements of Final Pre-Trial Order;
reviewing case law re: damages; conferring with FWM.

02/09/02 DAM Researching case law re: entire market value of damages.

02/10/02 DAM Revising portions of Final Pre-Trial Order

02/11/02 FWM Prepare draft issues of law. Confer with local counsel re
trial issues. Telephone conference with V. Jankowski.
Prepare letter to W. Harris.

CDW Docketing matters;

JLC Drafting jury instructions, and reviewing and revising
same, including misc. conferences with FWM re issues;

DAM Preparing and revising elements of Final Pre-Trial Order;
conferring with FWM re: strategy and tactics; reviewing
Blount's FPTO elements; revising draft letters to opposing
counsel.

02/12/02 FWM Telephone conferences with L. Bortz. Forward draft
sections of pretrial order to W. Harris. Confer with DAM
and JLC re witnesses.

JLC Reviewing and revising jury instructions; organizing jury
instructions, including checking for gaps in overall
issues and preparing instructions for same;

DAM Preparing and revising element of FPTO; preparing motion
to exclude FWM testimony from trial.

02/13/02 FWM Telephone conferences with S. Eiklor and W. Harris.
Review jury instructions. Telephone conference with L.
Bortz.

JLC Complete draft of jury instructions for FWM review; draft
proposed verdict form;

DAM Preparing and revising elements of FPTO; revising Motion
and Memorandum to Exclude FWM Testimony.

02/14/02 FWM Office conference with L. Bortz and DAM re trial
preparation and pretrial order. Telephone conference with
W. Harris.

JLC Confer with DAM, and complete verdict form with special
interrogatories;

DAM Meeting with Leslie Bortz and FWM; reviewing jury
instructions; preparing letter to opposing counsel re:
privileged document list.

02/15/02 FWM Telephone conference with W. Harris. Review letter to
Judge re extension. Telephone conference with T. Corrin
re sketch of burner. Confer with DAM re jury instructions.

JT-APP 2706

WOOD, PHILLIPS, VAN SANTEN, CLARK & MORTIMER

SUITE 3800
500 WEST MADISON STREET
CHICAGO, ILLINOIS 60661-2511

FEIN. 36-2121621
TELEPHONE (312) 876-1800

Robert H. Peterson Co.

Page: 3

02/28/02

Account No: 742-00008M

Statement No: 13

RE: GOLDEN BLOUNT, INC. v. ROBERT H. PETERSON CO.
DAM Reviewing jury instructions; reviewing transcript of
Leslie Bortz; conferring with FWM.

- 02/16/02 DAM Completing review of jury instructions.
- 02/18/02 FWM Revisions to pretrial order materials. Confer with JLC re jury instructions. Telephone conference with W. Harris.
JLC Misc. research and checking of background facts re specific points in jury instructions (including notice of infringement issue and party contentions), including conferring with FWM and DAM re comments to draft jury instructions, and revise jury instructions for filing with pretrial order;
DAM Revising portions of Pre-Trial Order; conferring with FWM; reviewing deposition transcript of Leslie Bortz; conferring with JLC re: jury instructions.
- 2/19/02 JLC Complete misc. instructions and jury interrogatory/verdict for filing with pretrial order per court requirement;
FWM Review correspondence from W. Harris re stipulations. Telephone conference with C. Gaines. Telephone conference with L. Bortz and T. Corrin. Prepare letters to Harris and J. Sellinger forwarding pretrial materials.
DAM Reviewing deposition transcripts of Leslie Bortz; revising portions of Final Pre-Trial Order; conferring with FWM several times.
- 02/20/02 FWM Review final draft of pretrial order. Confer with DAM re stipulations. Prepare letter to W. Harris re changes to pretrial order. Telephone conferences with W. Harris, L. Bortz and local counsel.
DAM Reviewing deposition transcripts of Leslie Bortz and Bill McLaughlin; revising portions of Final Pre-Trial Order; conferring with FWM.
- 02/21/02 FWM Preparation of trial materials. Review motion for protective order. Confer with DAM.
DAM Completing review of FWM deposition transcript; conferring with FWM re: strategy; conferring with local counsel re: conference requirement re: Motion to Exclude FWM Testimony.
- 02/22/02 FWM Prepare photographs of Peterson burner and Fyreside Shoppe burner. Prepare letter to J. Palaski. Prepare letter to L. Bortz. Telephone conference with W. Harris and confer with DAM re court schedule.
DAM Preparing Certificate of Conference; conferring with FWM; reviewing exhibits and proofs re: invalidity.
JLC Legal research and assemble materials regarding requirements for proving prior use;

JT-APP 2707

WOOD, PHILLIPS, VAN SANTEN, CLARK & MORTIMER

SUITE 3800
500 WEST MADISON STREET
CHICAGO, ILLINOIS 60661-2511

FEIN. 36-2121621
TELEPHONE (312) 876-1800

Robert H. Peterson Co.

Page: 4
02/28/02
Account No: 742-00008M
Statement No: 13

RE: GOLDEN BLOUNT, INC. v. ROBERT H. PETERSON CO.

02/25/02 FWM Office conference with ARCA re preparation of trial exhibits.

DAM Reviewing case law and treatises re: corroboration of oral testimony re: invalidity; extended conferences with opposing counsel re: motion to exclude FWM.

02/26/02 FWM Review price lists for AV8 valve. Telephone conference with W. Harris re continuance of trial date. Confer with L. Bortz. Review motion to waive jury trial. Prepare letter to W. Harris.

DAM Completing review of case law re: corroboration; revising motion to exclude testimony of FWM at trial; preparing transmittal letter to local counsel re: filing matter.

02/27/02 FWM Review motion for 60 day continuance. Prepare letter to W. Harris. Telephone conference with J. Sellinger re pretrial conference. Confer with DAM re pretrial conference. Prepare for pretrial conference. Telephone conference with W. Harris re changes to scheduling.

DAM Reviewing Golden Blount Jury Instructions; conferring with John Pulaski re: prior art; conferring with FWM re: issues to raise at Pre-Trial Conference; preparing for Final Pre-Trial Conference.

02/28/02 CDW litigation docket.

DAM Completing review of Golden Blount Jury Instructions; conferring with FWM.

JSM Confer with DAM - research issue of testimony at trial of FWM regarding opinion/wilfulness.

Current Services Rendered for Matter 57,727.75

Deposition of F.W. McLaughlin and Leslie Bortz. 793.80

Services and disbursements provided by Jenken & Gilchrist for the month of January 2002. 841.07

Federal Express shipment to Dallas TX on 02/05/02 17.10

Telecopier 51.11

Patent Copies 5.00

Disbursements per Matter Thru 02/28/02 1,708.08

CURRENT MONTH TOTAL 59,435.83

Previous Balance \$44,082.39

02/08/02 Payment - Thank you. -15,818.73

JT-APP 2708

WOOD, PHILLIPS, VAN SANTEN, CLARK & MORTIMER

SUITE 3800
500 WEST MADISON STREET
CHICAGO, ILLINOIS 60661-2511

FEIN. 36-2121621
TELEPHONE (312) 876-1800

Robert H. Peterson Co.
2500 W. Arthington
Chicago IL 60612

Page: 1
02/28/02
Account No: 742-99999M
Statement No: 920820

Attn: Leslie Bortz

MISCELLANEOUS EXPENSES:

Telephone toll charges	8.73
Telecopier	7.85
Postage	10.10
	<hr/>
Disbursements per Matter Thru 02/28/02	26.68
CURRENT MONTH TOTAL	26.68
Previous Balance	\$82.60
2/08/02 Payment - Thank you.	-43.49
Total Matter Balance Due	<u>\$65.79</u>

Past Due Amounts					
<u>0-30</u>	<u>31-60</u>	<u>61-90</u>	<u>91-120</u>	<u>121-180</u>	<u>181+</u>
26.68	27.90	11.21	0.00	0.00	0.00

PAYMENTS RECEIVED AFTER THE DATE OF THIS INVOICE WILL APPEAR
ON YOUR NEXT BILLING STATEMENT

JT-APP 2709

WOOD, PHILLIPS, KATZ, CLARK & MORTIMER
 SUITE 3800
 500 W. MADISON STREET
 CHICAGO, IL 60661
 TEL: (312) 876-1800
 FAX: (312) 876-2020

Robert H. Peterson Co.
 2500 W. Arthington
 Chicago IL 60612

Page: 1
 03/31/02
 Account No: 742-00008M
 Statement No: 14

Attn: Leslie Bortz

RE: GOLDEN BLOUNT, INC. v. ROBERT H. PETERSON CO.

	Hours	
03/01/02 CDW Docketing events, cc'ing copies of pleadings and orders to DAM/FWM.	0.50	
03/05/02 FWM Confer with local counsel re court handling of Markman determination.	0.30	
03/06/02 FWM Review amended scheduling order. Prepare letter to L. Bortz re amended scheduling order.	0.50	
03/20/02 FWM Review Blount's response to motion to exclude testimony.	0.75	
03/26/02 FWM Confer with L. Bortz. Prepare letter to L. Bortz re trial schedule.	0.30	
03/27/02 DAM Reviewing opposition brief to exclude FWM testimony at trial; conferring with FWM.	0.75	
03/28/02 FWM Confer with DAM re motion to exclude testimony.	0.50	
	<hr/>	
Current Services Rendered for Matter	5.74	<hr/> 1,148.25

Recapitulation

<u>Attorney</u>	<u>Hours</u>	<u>Hourly Rate</u>	<u>Total</u>
F.W. McLaughlin	2.35	\$320.00	\$752.00
D.A. Monco	0.75	320.00	240.00
Chris D. Wood	2.64	59.19	156.25

Airline Expenses for FWM and DAM.	590.00
Profession Fees and Services rendered by Jenkins and Gilchrist for Gas Burner for fireplace.	771.67
Federal Express shipment to Dallas TX on 02/19/02	17.10
Federal Express shipment to Howell NJ on 02/22/02	11.43
Federal Express shipment to Richardson TX on 02/14/02	10.08
Telecopier	22.61
	<hr/>
Disbursements per Matter Thru 03/31/02	1,422.89
CURRENT MONTH TOTAL	2,571.14
Previous Balance	\$87,699.49

JT-APP 2710

Robert H. Peterson Co.

Page: 2

03/31/02

Account No: 742-00008M

Statement No: 14

RE: GOLDEN BLOUNT, INC. v. ROBERT H. PETERSON CO.
Total Matter Balance Due

\$90,270.63

Past Due Amounts					
<u>0-30</u>	<u>31-60</u>	<u>61-90</u>	<u>91-120</u>	<u>121-180</u>	<u>181+</u>
2,571.14	77,487.66	7,613.91	0.00	2,597.92	0.00

PAYMENTS RECEIVED AFTER THE DATE OF THIS INVOICE WILL APPEAR
ON YOUR NEXT BILLING STATEMENT

JT-APP 2711

WOOD, PHILLIPS, KATZ, CLARK & MORTIMER
 SUITE 3800
 500 W. MADISON STREET
 CHICAGO, IL 60661
 TEL: (312) 876-1800
 FAX: (312) 876-2020

Robert H. Peterson Co.
 2500 W. Arthington
 Chicago IL 60612

Page: 1
 03/31/02
 Account No: 742-99999M
 Statement No: 920821

Attn: Leslie Bortz

MISCELLANEOUS EXPENSES:

Photocopies	97.80
Telephone toll charges	3.23
	<hr/>
Disbursements per Matter Thru 03/31/02	101.03
CURRENT MONTH TOTAL	101.03
Previous Balance	\$65.79
Total Matter Balance Due	<u>\$166.82</u>

Past Due Amounts					
<u>0-30</u>	<u>31-60</u>	<u>61-90</u>	<u>91-120</u>	<u>121-180</u>	<u>181+</u>
101.03	26.68	27.90	0.00	11.21	0.00

PAYMENTS RECEIVED AFTER THE DATE OF THIS INVOICE WILL APPEAR
 ON YOUR NEXT BILLING STATEMENT

JT-APP 2712

REVISED PER 1-1-01

WOOD, PHILLIP, KATZ, CLARK, & MORTIMER
SUITE 3800
500 W. MADISON STREET
CHICAGO, IL 60661
TEL: (312) 876-1800
FAX: (312) 876-2020

Robert H. Peterson Co.
2500 W. Arthington
Chicago IL 60612

Page: 1
04/30/02
Account No: 742-00008M
Statement No: 15

Attn: Leslie Bortz

RE: GOLDEN BLOUNT, INC. v. ROBERT H. PETERSON CO.

	Hours
04/01/02 CDW Updating litigation docket.	0.12 .12
04/08/02 FWM Confer with local counsel re proposed findings of fact and conclusions of law. Review files for preparing findings.	1.25
04/09/02 FWM Prepare draft findings of fact and conclusions of law.	6.00
04/10/02 FWM Revise proposed findings.	2.00
04/12/02 DAM Reviewing and revising findings of fact and conclusions of law.	1.25
04/15/02 FWM Confer with DAM re proposed findings.	0.50
04/16/02 FWM Legal research in connection with proposed conclusions of law.	3.50
04/17/02 FWM Amend proposed findings to include exhibits. Confer with W. Harris.	3.00
DAM Reviewing revised findings of fact and conclusions of law.	1.00
04/18/02 FWM Telephone conference with L. Bortz. Finalize proposed findings of fact and conclusions of law and forward to local counsel Confer with W. Harris re pretrial order and review draft.	2.00
04/19/02 FWM Confer with local counsel and revise proposed findings. Confer with W. Harris.	2.00
04/25/02 CDW Docketing events; updating litigation file.	1.25 0.60
04/29/02 DAM Conferring with FWM re: pretrial hearing.	0.25
04/30/02 FWM Prepare for pretrial hearing. Confer with local counsel.	1.75
CDW Updating litigation docket.	0.20
Current Services Rendered for Matter	27.44 8,071.25

JT-APP 2713

Robert H. Peterson Co.

Page: 2

04/30/02

Account No: 742-C0008M

Statement No: 15

RE: GOLDEN BLOUNT, INC. v. ROBERT H. PETERSON CO.
Recapitulation

<u>Attorney</u>	<u>Hours</u>	<u>Hourly Rate</u>	<u>Total</u>
F.W. McLaughlin	22.00	\$320.00	\$7,040.00
D.A. Monco	2.50	320.00	800.00
Chris D. Wood	2.94	78.66	231.25

Professional services of Jenkins & Gilchrist through March 31, 2002	1,292.20
Additional cost for air fare for FWM and DAM	70.00
Telecopier	1.50

Disbursements per Matter Thru 04/30/02	1,363.70
--	----------

CURRENT MONTH TOTAL	9,434.95
---------------------	----------

Previous Balance	\$90,270.63
------------------	-------------

04/03/02	Payment - Thank you.	-2,597.92
04/03/02	Payment - Thank you.	-7,613.91
04/30/02	Payment - Thank you.	-17,551.83

Total Payments	-27,763.66
----------------	------------

Total Matter Balance Due	<u>\$71,941.92</u>
--------------------------	--------------------

Past Due Amounts					
<u>0-30</u>	<u>31-60</u>	<u>61-90</u>	<u>91-120</u>	<u>121-180</u>	<u>181+</u>
12,006.09	0.00	59,935.83	0.00	0.00	0.00

PAYMENTS RECEIVED AFTER THE DATE OF THIS INVOICE WILL APPEAR
ON YOUR NEXT BILLING STATEMENT

JT-APP 2714

WOOD, PHILLIPS, KATZ, CLARK, & MORTIMER
SUITE 3800
500 W. MADISON STREET
CHICAGO, IL 60661
TEL: (312)876-1800
FAX: (312)876-2020

Page: 1

05/31/02

Robert H. Peterson Co.
2500 W. Arthington
Chicago IL 60612

Account No: 742-00008M
Statement No: 16

Attn: Leslie Bortz

RE: GOLDEN BLOUNT, INC. v. ROBERT H. PETERSON CO.

	Hours
05/01/02	
FWM Telephone conference with W. Harris. Organize materials for pretrial conference.	0.75
05/02/02	
FWM Prepare for pretrial conference.	3.00
DAM Preparing for pretrial conference; reviewing pretrial order.	3.00
03/02	
FWM Attend pretrial conference in Dallas.	4.00
DAM Attend the pretrial conference in Dallas.	4.00
05/06/02	
FWM Telephone conference with and prepare letter to L. Bortz re pretrial conference. Telephone conference with local counsel. Review files re updating discovery.	2.25
5/07/02	
CDW Updating, printing and circulating litigation docket.	0.25
5/14/02	
DAM Confering with ARCCA re trial exhibits.	0.25
5/16/02	
DAM Confering with FWM re status.	0.25
5/20/02	
FWM Telephone conference with L. Bortz. Review Blount's claim construction brief. Prepare letter to L. Bortz. Prepare memo to D. Monco re support in patent for claim terminology.	4.50
CDW Docketing events.	0.40
DAM Reviewing Golden Blount's Markman brief;	

JT-APP 2715

Robert H. Peterson Co.

Page: 2

05/31/02

Account No: 742-00008M

Statement No: 16

RE: GOLDEN BLOUNT, INC. v. ROBERT H. PETERSON CO.

	Hours	
conferring with FWM; preparing Peterson Co.'s Markman Brief.	4.50	
05/21/02 DAM Preparing Peterson Co.'s Markman Brief.	4.50	
05/22/02 FWM Telephone conference with L. Bortz. Review updated sales figures. Review discovery responses to determine if supplementation is necessary. Office conference with ARCCA re litigation support services.	1.25	
DAM Meeting with ARCCA representatives re exhibits; reviewing Markman Brief; conferring with FWM.	4.50	
05/23/02 FWM Review draft brief re claim construction and confer with DAM.	1.75	
DAM Revising Markman Brief; conferring with FWM; reviewing drawings from ARCCA.	3.00	
05/24/02 FWM Review revised brief and exhibits.	1.25	
DAM Revising and finalizing Opening Markman Brief; assembling exhibits for filing.	3.50	
05/28/02 FWM Review letter from B. Harris re opinion testimony. Confer with local counsel re Markman brief and hearing on motion for protective order. Revise brief and forward to local counsel.	3.00	
05/30/02 FWM Review file history and filed brief. Prepare letter to L. Bortz.	0.50	
Current Services Rendered for Matter	50.40	16,001.25

Recapitulation

<u>Attorney</u>	<u>Hours</u>	<u>Hourly Rate</u>	<u>Total</u>
F.W. McLaughlin	22.25	\$320.00	\$7,120.00
D.A. Monco	27.50	320.00	8,800.00
Chris D. Wood	0.65	125.00	81.25

To Jenkins & Gilchrist for professional services through April 30, 2002	1,268.23
Travel Expenses of trip to Dallas, Texas on May 2nd and 3rd, 2002	577.75

Robert H. Peterson Co.

Page: 3

05/31/02

Account No: 742-00008M

Statement No: 16

RE: GOLDEN BLOUNT, INC. v. ROBERT H. PETERSON CO.

Travel Expenses of trip to Dallas, Texas on May 2nd and 3rd, 2002	638.00
Telecopier	6.93
Disbursements per Matter Thru 05/31/02	2,490.91
CURRENT MONTH TOTAL	18,492.16
Previous Balance	\$71,941.92
Total Matter Balance Due	<u>\$90,434.08</u>

Past Due Amounts					
0-30	31-60	61-90	91-120	121-180	181+
18,492.16	9,434.95	2,571.14	59,935.83	0.00	0.00

PAYMENTS RECEIVED AFTER THE DATE OF THIS INVOICE WILL APPEAR
ON YOUR NEXT BILLING STATEMENT

JT-APP 2717

WOOD, PHILLIPS, KATZ, CLARK, & MORTIMER
 SUITE 3800
 500 W. MADISON STREET
 CHICAGO, IL 60661
 TEL: (312)876-1800
 FAX: (312)876-2020

Robert H. Peterson Co.
 2500 W. Arthington
 Chicago IL 60612

Page: 1
 05/31/02
 Account No: 742-99999M
 Statement No: 920823

Attn: Leslie Bortz

MISCELLANEOUS EXPENSES:

Photocopies	81.40
Telephone toll charges	1.00
Postage	2.41
	<hr/>
Disbursements per Matter Thru 05/31/02	84.81
CURRENT MONTH TOTAL	84.81
Previous Balance	\$143.31
Total Matter Balance Due	<u>\$228.12</u>

Past Due Amounts					
<u>0-30</u>	<u>31-60</u>	<u>61-90</u>	<u>91-120</u>	<u>121-180</u>	<u>181+</u>
94.81	15.60	101.03	26.68	0.00	0.00

PAYMENTS RECEIVED AFTER THE DATE OF THIS INVOICE WILL APPEAR
 ON YOUR NEXT BILLING STATEMENT

JT-APP 2718

WOOD, PHILLIPS, KATZ, CLARK, & MORTIMER
 SUITE 3800
 500 W. MADISON STREET
 CHICAGO, IL 60661
 TEL: (312)876-1800
 FAX: (312)876-2020

Robert H. Peterson Co.
 2500 W. Arthington
 Chicago IL 60612

Page: 1
 06/30/02
 Account No: 742-00008M
 Statement No: 17

Attn: Leslie Bortz

RE: GOLDEN BLOUNT, INC. v. ROBERT H. PETERSON CO.

	Hours	
06/04/02 DAM Reviewing Reply Brief re: claim interpretation; conferring with FWM.	0.50	
06/05/02 FWM Review Blount's reply brief re claim construction. Confer with DAM.	1.00	
06/07/02 JJK Litigation docket support.	0.25	
06/14/02 JJK Litigation docket support.	0.25	
05/20/02 FWM Review opinion on use of oral testimony of prior public use to invalidate patent.	0.50	
06/21/02 FWM Review exhibits and proposed findings of fact. Prepare draft of Section 282 Notice of evidence to rely on for patent invalidity.	2.50	
JJK Litigation docket support.	0.25	
06/26/02 FWM Revise notice. Confer with local counsel.	1.00	
06/28/02 JJK Litigation docket support.	0.25	
Current Services Rendered for Matter	6.50	1,960.00

Recapitulation

<u>Attorney</u>	<u>Hours</u>	<u>Hourly Rate</u>	<u>Total</u>
F.W. McLaughlin	5.00	\$320.00	\$1,600.00
D.A. Monco	0.50	320.00	160.00
JOHN J. KING	1.00	200.00	200.00

Additional Airline expense.	80.00
Services of Jenkins & Gilchrist through May 31, 2002	3,167.90
Federal Express shipment to Dallas TX on 5/24/02	19.38
Travel Expenses of trip to Dallas, TX on May 2, 2002.	577.75
Telephone toll charges	15.56
Telecopier	1.57
Disbursements per Matter Thru 06/30/02	3,862.16
CURRENT MONTH TOTAL	5,822.16

JT-APP 2719

Robert H. Peterson Co.

Page: 2

06/30/02

Account No: 742-00008M

Statement No: 17

RE: GOLDEN BLOUNT, INC. v. ROBERT H. PETERSON CO.
Previous Balance

\$90,434.08

06/04/02 Payment - Thank you.

-59,462.51

Total Matter Balance Due

\$36,793.73

Past Due Amounts					
<u>0-30</u>	<u>31-60</u>	<u>61-90</u>	<u>91-120</u>	<u>121-180</u>	<u>181+</u>
24,314.32	0.00	9,434.95	2,571.14	473.32	0.00

PAYMENTS RECEIVED AFTER THE DATE OF THIS INVOICE WILL APPEAR
ON YOUR NEXT BILLING STATEMENT

JT-APP 2720

WOOD, PHILLIPS, KATZ, CLARK, & MORTIMER
 SUITE 3800
 500 W. MADISON STREET
 CHICAGO, IL 60661
 TEL: (312)876-1800
 FAX: (312)876-2020

Robert H. Peterson Co.
 2500 W. Arthington
 Chicago IL 60612

Page: 1
 06/30/02
 Account No: 742-99999M
 Statement No: 920824

Attn: Leslie Bortz

MISCELLANEOUS EXPENSES:

Photocopies	6.80
Telecopier	4.70
	<hr/>
Disbursements per Matter Thru 06/30/02	11.50
CURRENT MONTH TOTAL	11.50
Previous Balance	\$228.12
Total Matter Balance Due	<u>\$239.62</u>

Past Due Amounts					
<u>0-30</u>	<u>31-60</u>	<u>61-90</u>	<u>91-120</u>	<u>121-180</u>	<u>181+</u>
96.31	0.00	15.60	101.03	26.68	0.00

PAYMENTS RECEIVED AFTER THE DATE OF THIS INVOICE WILL APPEAR
 ON YOUR NEXT BILLING STATEMENT

JT-APP 2721

WOOD, PHILLIPS, KATZ, CLARK, & MORTIMER
SUITE 3800
500 W. MADISON STREET
CHICAGO, IL 60661
TEL: (312)876-1800
FAX: (312)876-2020

Robert H. Peterson Co.
2500 W. Arthington
Chicago IL 60612

Page: 1
07/31/02
Account No: 742-00008M
Statement No: 18

Attn: Leslie Bortz

RE: GOLDEN BLOUNT, INC. v. ROBERT H. PETERSON CO.

	Hours
07/03/02 FWM Prepare exhibits. Confer with DAM re trial preparation.	2.00
07/05/02 FWM Telephone conference with L. Bortz. Confer with DAM.	1.00
07/08/02 DAM Preparing cross examination of Golden Blount.	7.00
07/09/02 DAM Preparing for trial; conferring with Tod Corrin.	3.50
07/10/02 DAM Preparing for trial; preparing exhibits for scanning; conferring with local counsel re: exhibit list	3.50
07/11/02 DAM Forwarding exhibits to Texas for filing; preparing for trial.	2.50
07/12/02 DAM Preparing direct examination of Tod Corrin.	6.00
07/13/02 DAM Completing direct examination questions of Tod Corrin.	1.25
07/15/02 FWM Confer with DAM re trial preparation. Telephone conferences with D. Dworkin and J. Palaski.	2.00
DAM Preparing for trial; preparing direct examination of Vince Jankowski and Darryl Dworkin; conferring with Messrs. Jankowski and Dworkin; conferring with local counsel's secretary re: exhibits;	

JT-APP 2722

Robert H. Peterson Co.

Page: 2

07/31/02

Account No: 742-00008M

Statement No: 18

RE: GOLDEN BLOUNT, INC. v. ROBERT H. PETERSON CO.

	Hours
conferring with John Palaski.	7.00
07/16/02	
FWM Telephone conferences with local counsel re litigation support and court requirements. Telephone conference with T. Corrin. Discuss trial strategy with DAM.	1.75
DAM Preparing for trial.	7.00
07/17/02	
DAM Preparing for trial.	4.00
07/18/02	
FWM Initial review of examination questions. Prepare for testimony.	2.50
DAM Preparing for trial.	6.50
07/19/02	
FWM Review deposition transcript. Review draft witness questions. Telephone conference with L. Bortz.	4.25
07/20/02	
DAM Preparing for trial.	2.50
07/22/02	
FWM Review exhibits. Legal research re secondary considerations in obviousness determination. Confer with paralegal service re trial assistance. Telephone conferences with L. Bortz and J. Sellinger. Confer with DAM.	6.00
DAM Preparing for trial.	9.00
JJK Litigation docket support.	1.25
07/23/02	
FWM Confer with DAM re examination questions. Confer with L. Bortz. Review deposition transcript	3.25
DAM Preparing for trial.	8.00
07/24/02	
FWM Office conference with L. Bortz and DAM to prepare for trial. Review testimony outlines.	6.50

JT-APP 2723

Robert H. Peterson Co.

Page: 3

07/31/02

Account No: 742-00008M

Statement No: 18

RE: GOLDEN BLOUNT, INC. v. ROBERT H. PETERSON CO.

	Hours
DAM Meeting with Leslie Bortz; preparing for trial.	9.00
07/25/02	
FWM Assemble materials for trial. Telephone conferences with paralegal and local counsel re final arrangements. Confer with DAM re opening statement and testimony questions.	5.50
DAM Preparing for trial.	10.00
JJK Update Litigation file and index prior to trial.	0.50
07/26/02	
FWM Final trial preparation.	5.50
DAM Preparing for trial.	8.00
07/27/02	
DAM Preparing for trial.	4.00
07/28/02	
DAM Preparing for trial; meeting with witnesses.	8.00
FWM Confer with DAM re trial preparation. Prepare witnesses.	7.00
07/29/02	
DAM On trial.	11.00
FWM Attend trial. prepare witnesses.	11.00
07/30/02	
DAM On trial.	12.00
FWM Attend trial. Confer with DAM re closing argument.	11.00
07/31/02	
DAM On trial; return home.	7.00
FWM Attend trial.	7.00
Current Services Rendered for Matter	214.75 68,510.00

Recapitulation

<u>Attorney</u>	<u>Hours</u>	<u>Hourly Rate</u>	<u>Total</u>
F.W. McLaughlin	76.25	\$320.00	\$24,400.00
D.A. Monco	136.75	320.00	43,760.00

Robert H. Peterson Co.

Page: 4

07/31/02

Account No: 742-00008M

Statement No: 18

RE: GOLDEN BLOUNT, INC. v. ROBERT H. PETERSON CO.

John J. King	1.75	200.00	350.00
Travel Agency fee for plane tickets ordered on 05/02/02.			25.00
Exhibit copies.			644.08
Professional fees and expenses provided by Jenkens & Gilchrist for the month of June 2002.			554.72
Travel Expenses of trip to Dallas, TX on 07/27 thru 07/31.			1,987.31
Travel Expenses of trip to Dallas, TX on 07/28 thru 07/31			1,382.53
Photocopies			3.60
			<hr/>
Disbursements per Matter Thru 07/31/02			4,597.24
CURRENT MONTH TOTAL			73,107.24
Previous Balance			\$36,793.73
			<hr/>
Total Matter Balance Due			<u>\$109,900.97</u>

	Past Due Amounts				
<u>0-30</u>	<u>31-60</u>	<u>61-90</u>	<u>91-120</u>	<u>121-180</u>	<u>181+</u>
73,107.24	5,822.16	18,492.16	9,434.95	2,571.14	473.32

PAYMENTS RECEIVED AFTER THE DATE OF THIS INVOICE WILL APPEAR ON YOUR NEXT BILLING STATEMENT

JT-APP 2725

WOOD, PHILLIPS, KATZ, CLARK, & MORTIMER
SUITE 3800
500 W. MADISON STREET
CHICAGO, IL 60661
TEL: (312) 876-1800
FAX: (312) 876-2020

Robert H. Peterson Co.
2500 W. Arthington
Chicago IL 60612

Page: 1
07/31/02
Account No: 742-99995M
Statement No: 920811

Attn: Leslie Bortz

GENERAL MATTERS:

Photocopies	1.00
Postage	3.10
	<hr/>
Disbursements per Matter Thru 07/31/02	4.10
CURRENT MONTH TOTAL	4.10
	<hr/>
Total Matter Balance Due	<u>\$4.10</u>

PAYMENTS RECEIVED AFTER THE DATE OF THIS INVOICE WILL APPEAR
ON YOUR NEXT BILLING STATEMENT

JT-APP 2726

WOOD, PHILLIPS, KATZ, CLARK, & MORTIMER
 SUITE 3800
 500 W. MADISON STREET
 CHICAGO, IL 60661
 TEL: (312) 876-1800
 FAX: (312) 876-2020

Robert H. Peterson Co.
 2500 W. Arthington
 Chicago IL 60612

Page: 1
 07/31/02
 Account No: 742-99999M
 Statement No: 920825

Attn: Leslie Bortz

MISCELLANEOUS EXPENSES:

Photocopies	44.20
Telephone toll charges	5.49
	<hr/>
Disbursements per Matter Thru 07/31/02	49.69
CURRENT MONTH TOTAL	49.69
Previous Balance	\$239.62
Total Matter Balance Due	<u>\$289.31</u>

Past Due Amounts					
<u>0-30</u>	<u>31-60</u>	<u>61-90</u>	<u>91-120</u>	<u>121-180</u>	<u>181+</u>
49.69	11.50	84.81	15.60	127.71	0.00

PAYMENTS RECEIVED AFTER THE DATE OF THIS INVOICE WILL APPEAR
 ON YOUR NEXT BILLING STATEMENT

JT-APP 2727

WOOD, PHILLIPS, KATZ, CLARK, & MORTIMER
SUITE 3800
500 W. MADISON STREET
CHICAGO, IL 60661
TEL: (312)876-1800
FAX: (312)876-2020

Robert H. Peterson Co.
2500 W. Arthington
Chicago IL 60612

Page: 1
08/31/02
Account-No: 742-00008M
Statement No: 19

Attn: Leslie Bortz

RE: GOLDEN BLOUNT, INC. v. ROBERT H. PETERSON CO.

	Hours
08/01/02 DAM Reviewing and organizing files and documents from trial.	1.50
08/02/02 FWM Review Richardson patent no. 4,971,031. Telephone conference with L. Bortz.	0.75
08/05/02 FWM Review motion to disregard testimony of J. Palaski. Confer with DAM. DAM Reviewing motion to exclude testimony; reviewing case law;	0.25 1.50
08/06/02 DAM Reviewing case law cited in Blount brief re: excluding testimony; researching case law re: same.	2.50
08/07/02 DAM Preparing opposition to motion to disregard testimony of John Palaski.	4.50
08/08/02 DAM Completing first draft of opposition to motion to exclude.	2.50
08/09/02 FWM Review judgment and confer with DAM and local counsel. DAM Reviewing order; conferring with FWM; conferring with Jerry Selinger several times.	1.00 1.00
08/10/02 DAM Reviewing Rule 52 FRCP.	0.50
08/12/02 DAM Reviewing Rule 52(b) and case law; reviewing Findings of Fact and Conclusions of Law.	4.50

Robert H. Peterson Co.

Page: 2

08/31/02

Account No: 742-00008M

Statement No: 19

RE: GOLDEN BLOUNT, INC. v. ROBERT H. PETERSON CO.

	Hours
JJK Research opinions and appeal statistics from the US District Court for the Northern District of Texas and other District Courts.	2.00
08/13/02 FWM Telephone conference with L. Bortz, T. Corrin and J. Bridgewater. Research rules re post trial procedures. Confer with DAM.	4.00
DAM Extended telephone conference with Leslie Bortz and Tod Corrin; preparing draft letter to distributors; conducting further review of Rule 52.	4.50
08/14/02 FWM Telephone conferences with L. Bortz. Review sales information relative to reducing damage amount. Review drawings and photographs for G44 system. Confer with DAM and local counsel.	4.25
DAM Preparing Motion under Rule 52(b); conferring with FWM and Jerry Selinger several time re: strategy; reviewing treatises re: Rule 57; conferring with client re: revised product.	5.50
08/15/02 DAM Preparing Motion re: documents under seal; revising Motion Under Rule 52(b); conferring with opposing counsel; conferring with local counsel re: transcripts.	4.50
08/16/02 FWM Review sales brochures. Prepare letter to L. Bortz re use of brochures. Prepare opinion letter re G44 burner.	4.00
DAM Revising Motion and Memo re: Rule 52; reviewing trial transcript; preparing transmittal to Lee Hutchinson.	4.50
08/19/02 FWM Meet with attorneys from Freeborn & Peters. Finalize opinion letter. Research implications from lack of testimony on reasonable royalty.	2.50
DAM Meeting with Lee Hutchinson re: status;	

JT-APP 2729

Robert H. Peterson Co.

Page: 3

08/31/02

Account No: 742-00008M

Statement No: 19

RE: GOLDEN BLOUNT, INC. v. ROBERT H. PETERSON CO.

	Hours
preparing motion under Rules 52/59 and supporting memo; reviewing case law re: Rules 602 and 701, Federal Express shipment to Federal Rules of Evidence.	7.50
08/20/02	
FWM Review reply to draft motion to exclude. Forward to local counsel for filing. Confer with DAM re motion for new trial.	1.00
DAM Revising Rule 52/59 Motion; conferring with Lee Hutchinson and Jennifer Fitzgerald; researching case law re: opinion testimony.	6.00
08/21/02	
FWM Review draft motion for a new trial and confer with DAM. Telephone conference with L. Bortz.	2.00
DAM Further revising Rule 52/59 post trial motion; conferring with FWM re: same.	2.50
08/22/02	
FWM Review revised motions and confer with DAM.	1.25
DAM Revising motion and memo re: Rules 52/59 to incorporate changes from Jennifer Fitzgerald; conferring with FWM; conferring with Leslie Bortz re: past May 1 sales.	2.00
08/23/02	
DAM Conferring with local counsel re: filing of motions; preparing letter re: Joint Motion to seal documents; conferring with opposing counsel re: plaintiff's motions.	2.50
08/26/02	
DAM Reviewing documents; conferring with FWM.	1.25
08/28/02	
JSM Confer with DAM and legal research regarding required challenges to findings before appeal.	1.50
JJK Legal research regarding response to a motion to modify a judgement.	0.75
08/30/02	
FWM Review post trial motions filed by	

JT-APP 2730

Robert H. Peterson Co.

Page: 4

08/31/02

Account No: 742-00008M

Statement No: 19

RE: GOLDEN BLOUNT, INC. v. ROBERT H. PETERSON CO.

	Hours	
Blount. Telephone conference with L. Bortz.	2.00	
DAM Reviewing Blount post trial motions; conferring with FWM.	2.50	
JJK Litigation docket support.	1.00	
08/31/02		
DAM Reviewing case law cited in Blount motions.	1.50	
	91.50	28,830.00
Current Services Rendered for Matter		

Recapitulation

<u>Attorney</u>	<u>Hours</u>	<u>Hourly Rate</u>	<u>Total</u>
J.S. Mortimer	1.50	\$320.00	\$480.00
F.W. McLaughlin	23.00	320.00	7,360.00
D.A. Monco	63.25	320.00	20,240.00
John J. King	3.75	200.00	750.00

UPS charges for boxes sent from Judge Buckmeyer in Dallas, TX to us in the month of August.	175.11
Services and disbursements of Richardson, TX associate for trial presentation for the period of July 26 through July 31, 2002.	3,780.07
Telephone toll charges	56.04
Disbursements and Fees to Jenkins and Gilchrist for professional services through July 31, 2002	2,801.16
Copies of various documents regarding above case.	288.59
Federal Express shipment to Dallas TX on 6/11/02	41.68
Federal Express shipment to Dallas, TX on 07/25/02.	10.33
Federal Express shipment to Dallas, TX on 07/25/02.	46.55
Federal Express shipment to Dallas TX on 07/25/02.	59.20
Federal Express shipment to Richardson, TX on 07/25/02	26.08
Federal Express shipment to Dallas, TX on 07/26/02	56.55
Travel Expenses of trip to Dallas, TX on July 29 through August 1, 2002.	1,382.53
Photocopies	33.60
Telecopier	13.40
Patent Copies	5.00
	8,775.89
Disbursements per Matter Thru 08/31/02	

Robert H. Peterson Co.

Page: 5
08/31/02
Account No: 742-00008M
Statement No: 19

RE: GOLDEN BLOUNT, INC. v. ROBERT H. PETERSON CO.

CURRENT MONTH TOTAL	37,605.89
Previous Balance	\$109,900.97
08/06/02 Payment - Thank you.	-2,571.14
08/06/02 Payment - Thank you.	-9,434.95
Total Payments	-12,006.09
Total Matter Balance Due	<u>\$135,500.77</u>

Past Due Amounts					
<u>0-30</u>	<u>31-60</u>	<u>61-90</u>	<u>91-120</u>	<u>121-180</u>	<u>181+</u>
37,605.89	73,107.24	5,822.16	18,492.16	0.00	473.32

PAYMENTS RECEIVED AFTER THE DATE OF THIS INVOICE WILL APPEAR
ON YOUR NEXT BILLING STATEMENT

JT-APP 2732

WOOD, PHILLIPS, KATZ, CLARK, & MORTIMER
 SUITE 3800
 500 W. MADISON STREET
 CHICAGO, IL 60661
 TEL: (312)876-1800
 FAX: (312)876-2020

Robert H. Peterson Co.
 2500 W. Arthington
 Chicago IL 60612

Page: 1
 08/31/02
 Account No: 742-99999M
 Statement No: 920826

Attn: Leslie Bortz

MISCELLANEOUS EXPENSES:

Photocopies	527.20
Telephone toll charges	15.35
Telecopier	20.99
	<hr/>
Disbursements per Matter Thru 08/31/02	563.54
CURRENT MONTH TOTAL	563.54
Previous Balance	\$289.31

08/06/02 Payment - Thank you.	-101.03
08/06/02 Payment - Thank you.	-15.60
	<hr/>
Total Payments	-116.63
Total Matter Balance Due	<u>\$736.22</u>

	Past Due Amounts				
<u>0-30</u>	<u>31-60</u>	<u>61-90</u>	<u>91-120</u>	<u>121-180</u>	<u>181+</u>
563.54	49.69	11.50	84.81	0.00	26.68

PAYMENTS RECEIVED AFTER THE DATE OF THIS INVOICE WILL APPEAR
 ON YOUR NEXT BILLING STATEMENT

JT-APP 2733

WOOD, PHILLIPS, KATZ, CLARK, & MORTIMER
SUITE 3800
500 W. MADISON STREET
CHICAGO, IL 60661
TEL: (312)876-1800
FAX: (312)876-2020

Robert H. Peterson Co.
2500 W. Arthington
Chicago IL 60612

Page: 1
09/30/02
Account No: 742-00008M
Statement No: 20

Attn: Leslie Bortz

RE: GOLDEN BLOUNT, INC. v. ROBERT H. PETERSON CO.

	Hours
09/01/02 DAM Preparing opposing memos to petition for attorneys fees and past May 1, 2002 damages	5.50
09/06/02 FWM Revise G44 opinion letter.	0.50
09/09/02 FWM Confer with opposing counsel and J. Sellinger re motion for an extension. Telephone conferences with L. Bortz re post trial motions.	1.00
09/13/02 DAM Revising oppositions to Blount's petitions for attorneys fees and supplemental damages; reviewing documents and status	1.50
09/16/02 FWM Revise response to motion for attorney fees. Telephone conference with L. Bortz.	1.50
DAM Reviewing documents relating to responses to Golden Blount	0.50
09/17/02 FWM Revise response for motion to increase award of damages.	1.00
09/18/02 FWM Review correspondence from J. Fitzgerald. Review sales and returns information. Telephone conferences with L. Bortz and T. Corrin. Review responses and confer with DAM.	1.75
DAM Finalizing Peterson Co.'s opposition to motions for attorneys fees and interest	4.00

Robert H. Peterson Co.

Page: 2

09/30/02

Account No: 742-00008M

Statement No: 20

RE: GOLDEN BLOUNT, INC. v. ROBERT H. PETERSON CO.

	Hours	
09/19/02		
FWM Final revisions to responses and forward to local counsel for filing.	1.00	
09/20/02		
DAM Reviewing opposition to Rule 52 motion	0.50	
09/23/02		
DAM Conferring with opposing counsel re: submission of unredacted fees with conditions; conferring with FWM; conferring with Jennifer Fitzgerald	0.50	
09/24/02		
DAM Conferring with opposing counsel re: redacted entries on petition for attorneys fees; preparing reply brief re: Rule 52(b) post trial motion.	1.00	
09/25/02		
DAM Preparing reply brief re: Rule 52(b) motion	4.50	
09/26/02		
DAM Drafting Reply Brief in Support of Rule 52(b) Motion; reviewing trial testimony	3.50	
09/27/02		
DAM Completing and revising Reply Memo in Support of Rule 52(b) Motion	3.00	
09/29/02		
DAM Further revising Reply Memo re: Rule 52(b)	2.00	
09/30/02		
FWM Review reply brief re second post trial motion. Confer with DAM.	0.75	
CBB Compile and Maintain Litigation Docket.	0.50	
DAM Revising Reply Brief re: Rule 52(b)	1.00	
		<hr/>
Current Services Rendered for Matter	35.50	11,312.50

Recapitulation

Attorney	Hours	Hourly Rate	Total
F.W. McLaughlin	7.50	\$320.00	\$2,400.00
D.A. Monco	27.50	320.00	8,800.00
Connie B. Berg	0.50	225.00	112.50

JT-APP 2735

Robert H. Peterson Co.

Page: 3

09/30/02

Account No: 742-00008M

Statement No: 20

RE: GOLDEN BLOUNT, INC. v. ROBERT H. PETERSON CO.

Legal services of Jenkins & Gilchrist through August 31, 2002	3,760.90
Federal Express shipment to LA Puente CA on 8/19/02	10.83
Federal Express shipment to Dallas TX on 8/22/02	19.77
Telephone toll charges	91.45
Telecopier	46.00
Messenger Service	25.00
	<hr/>
Disbursements per Matter Thru 09/30/02	3,953.95
One-half the cost of the trial transcript, for which Plaintiff's counsel has paid.	-1,287.25
	<hr/>
Total Credits for Expenses	-1,287.25
	<hr/>
CURRENT MONTH TOTAL	13,979.20
Previous Balance	\$135,500.77

09/04/02 Payment - Thank you. -18,492.16

Total Matter Balance Due \$130,987.81

Past Due Amounts					
<u>0-30</u>	<u>31-60</u>	<u>61-90</u>	<u>91-120</u>	<u>121-180</u>	<u>181+</u>
51,585.09	0.00	73,107.24	5,822.16	0.00	473.32

PAYMENTS RECEIVED AFTER THE DATE OF THIS INVOICE WILL APPEAR
ON YOUR NEXT BILLING STATEMENT

JT-APP 2736

WOOD, PHILLIPS, KATZ, CLARK, & MORTIMER
 SUITE 3800
 500 W. MADISON STREET
 CHICAGO, IL 60661
 TEL: (312)876-1800
 FAX: (312)876-2020

Robert H. Peterson Co.
 2500 W. Arthington
 Chicago IL 60612

Page: 1
 09/30/02
 Account No: 742-99999M
 Statement No: 920827

Attn: Leslie Bortz

MISCELLANEOUS EXPENSES:

Telephone charges	12.66
Photocopies	9.40
	<hr/>
Disbursements per Matter Thru 09/30/02	22.06
CURRENT MONTH TOTAL	22.06
Previous Balance	\$736.22

09/04/02 Payment - Thank you. -84.81

Total Matter Balance Due \$673.47

Past Due Amounts					
<u>0-30</u>	<u>31-60</u>	<u>61-90</u>	<u>91-120</u>	<u>121-180</u>	<u>181+</u>
585.60	0.00	49.69	11.50	0.00	26.68

PAYMENTS RECEIVED AFTER THE DATE OF THIS INVOICE WILL APPEAR
 ON YOUR NEXT BILLING STATEMENT

JT-APP 2737

WOOD, PHILLIPS, KATZ, CLARK, & MORTIMER
 SUITE 3800
 500 W. MADISON STREET
 CHICAGO, IL 60661
 TEL: (312) 876-1800
 FAX: (312) 876-2020

Robert H. Peterson Co.
 2500 W. Arthington
 Chicago IL 60612

Page: 1
 10/31/02
 Account No: 742-00008M
 Statement No: 21

Attn: Leslie Bortz

RE: GOLDEN BLOUNT, INC. v. ROBERT H. PETERSON CO.

	Hours	
10/02/02		
DAM revising and finalizing Reply Brief for filing; preparing transmittal letter re same	1.50	
10/04/02		
DAM conferring with local counsel re filing brief; reviewing brief re page limitation under local rule	0.50	
10/06/02		
DAM reviewing files and discarding duplicate pleadings	0.50	
10/08/02		
FWM Review Blount's replies to its post trial motions. Forward to L. Bortz.	1.00	
10/11/02		
DAM reviewing Golden Blount Reply Briefs; conferring with FWM re status	1.00	
10/31/02		
CBB Maintain litigation docket for October 1-31.	0.75	
	5.25	1,608.75
Current Services Rendered for Matter		

Recapitulation

<u>Attorney</u>	<u>Hours</u>	<u>Hourly Rate</u>	<u>Total</u>
F.W. McLaughlin	1.00	\$320.00	\$320.00
D.A. Monco	3.50	320.00	1,120.00
Connie B. Berg	0.75	225.00	168.75

Jenkins & Gilchrist professional services.	773.30
Computerized search conducted on August 12, 2002.	270.33
Computerized search conducted on August 16, 2002.	180.00
Federal Express shipment to Chicago IL on 8/26/02	8.26
Federal Express shipment to Chicago IL on 8/26/02. Ref.742.00008	8.26
Federal Express shipment to Dallas TX on 9/18/02	11.44

Robert H. Peterson Co.

Page: 2

10/31/02

Account No: 742-00008M

Statement No: 21

RE: GOLDEN BLOUNT, INC. v. ROBERT H. PETERSON CO.

Disbursements per Matter Thru 10/31/02	<u>1,251.59</u>
CURRENT MONTH TOTAL	2,860.34
Previous Balance	\$130,987.81
10/18/02 Payment - Thank you.	-5,822.16
Total Matter Balance Due	<u><u>\$128,025.99</u></u>

Past Due Amounts					
<u>0-30</u>	<u>31-60</u>	<u>61-90</u>	<u>91-120</u>	<u>121-180</u>	<u>181+</u>
2,860.34	15,266.45	36,318.64	73,107.24	0.00	473.32

PAYMENTS RECEIVED AFTER THE DATE OF THIS INVOICE WILL APPEAR
ON YOUR NEXT BILLING STATEMENT

JT-APP 2739

WOOD, PHILLIPS, KATZ, CLARK, & MORTIMER
SUITE 3800
500 W. MADISON STREET
CHICAGO, IL 60661
TEL: (312)876-1800
FAX: (312)876-2020

Robert H. Peterson Co.
2500 W. Arthington
Chicago IL 60612

Page: 1
10/31/02
Account No: 742-99999M
Statement No: 920828

Attn: Leslie Bortz

MISCELLANEOUS EXPENSES:

Photocopies	48.00
Postage	10.45
	<hr/>
Disbursements per Matter Thru 10/31/02	58.45
CURRENT MONTH TOTAL	58.45
Previous Balance	\$673.47
10/18/02 Payment - Thank you.	-11.50
Total Matter Balance Due	<u><u>\$720.42</u></u>

Past Due Amounts					
<u>0-30</u>	<u>31-60</u>	<u>61-90</u>	<u>91-120</u>	<u>121-180</u>	<u>181+</u>
58.45	22.06	563.54	49.69	0.00	26.68

PAYMENTS RECEIVED AFTER THE DATE OF THIS INVOICE WILL APPEAR
ON YOUR NEXT BILLING STATEMENT

JT-APP 2740

Wood, Phillips, Katz, Clark & Mortimer
500 West Madison Street
Suite 3800
Chicago, IL 60661
(312) 876-1800
(312) 876-2020

Peterson Co./Robert H.
2500 W. Arthington
Chicago IL 60612

11/30/2002

Statement No: 4109

Attn: Leslie Bortz

Account No: 00742-0001

TRADEMARK REAL-FYRE - INT. CLASS 11 - SERIAL NO. 123,251

Additional filing fee for renewal and Sec. 8 & 15.	200.00
Disbursements per Matter Thru 11/30/2002	<u>200.00</u>

CURRENT MONTH TOTAL 200.00

Total Matter Balance Due 200.00

Account No: 00742-0008

GOLDEN BLOUNT, INC. v. ROBERT H. PETERSON CO.

Maintained litigation docket.

Current Services Rendered for Matter:	<u>135.00</u>
---------------------------------------	---------------

Federal Express shipment to Dalla TX on 10/02/02	10.33
--	-------

To Jenkins & Gilchrist for services and disbursements in preparing, filing and serving reply brief.	274.97
---	--------

Disbursements per Matter Thru 11/30/2002	<u>285.30</u>
--	---------------

CURRENT MONTH TOTAL 420.30

Total Matter Balance Due 420.30

Account No: 00742-9995

GENERAL MATTERS:

Review files and prepare audit letter.

JT-APP 2741

Wood, Phillips, Katz, Clark & Mortimer
 500 West Madison Street
 Suite 3800
 Chicago, IL 60661
 (312) 876-1800
 Fax: (312) 876-2020

Peterson Co./Robert H.
 2500 W. Arthington
 Chicago IL 60612

Page: 1
 12/31/2002
 Account No: 00742-0008
 Statement No: 4385

Attn: Leslie Bortz

GOLDEN BLOUNT, INC. v. ROBERT H. PETERSON CO.

	Hours	
12/12/2002		
CBB Maintain litigation docket from 12/1/02-12/31/02.	0.60	
Current Services Rendered for Matter:		135.00

Recapitulation

<u>Attorney</u>	<u>Hours</u>	<u>Hourly Rate</u>	<u>Total</u>
Connie B. Berg	0.60	225.00	135.00
Services of ARCCA for pretrial preparation, including inventoried all documents and page total for document work; called local counsel to ascertain equipment and support resources; reviewed court website to determine local rules and needs; picked up and hand-delivered documents to firm to meet exchange deadline; imported documents on CD into Sanction software database; CD production for delivery of database to Legal Concierge in Dallas; Prepare graphical illustrations for fireplace gas burner versions 1 and 2 for markmen brief.			2,497.47
Disbursements per Matter Thru 12/31/2002			2,497.47
CURRENT MONTH TOTAL			2,632.47
Total Matter Balance Due			2,632.47

Wood, Phillips, Katz, Clark & Mortimer
500 West Madison Street
Suite 3800
Chicago, IL 60661
(312) 876-1800
Fax: (312) 876-2020

Peterson Co./Robert H.
2500 W. Arthington
Chicago IL 60612

Page: 1

02/28/2003

Account No: 00742-0008

Statement No: 4893

Attn: Leslie Bortz

GOLDEN BLOUNT, INC. v. ROBERT H. PETERSON CO.

	Hours
01/31/2003 CBB Maintain Litigation Docket for January 2003	0.60
02/17/2003 FWM Review court order. Confer with local counsel re extension. Confer with L. Bortz.	1.25
02/19/2003 FWM Prepare reply to court order. Prepare letters to L. Bortz and J. Fitzgerald. Review updated sales figures from L. Bortz.	1.00
02/19/2003 DAM reviewing Rule 62(d) re supercedeas bond; reviewing Court's Order	1.00
02/20/2003 FWM Telephone conference with L. Bortz and T. Corin. Revise response.	0.75
02/20/2003 DAM conferring with FWM re Supersedeas Bond and Notice of Appeal; further review of Supersedeas Bond	0.50
02/21/2003 FWM Forward response to local counsel for filing. Telephone conference with J. Sellinger re post trial matters. Confer with DAM re notice of appeal.	1.00
02/21/2003 DAM preparing Notice of Appeal; conferring with opposing counsel re extension of time to execute on Judgment; preparing letter agreement re same; conferring with FWM	3.00
02/24/2003 FWM Confer with local counsel re response.	0.75
02/24/2003 DAM revising Notice of Appeal; revising letter to opposing counsel re extension of time; conferring with FWM	1.25

JT-APP 2743

02/25/2003	DAM preparing and revising status report letter to Leslie Bortz; conferring with FWM	1.00
02/28/2003	FWM Correspond with local counsel forwarding Notice of Appeal.	0.30
02/28/2003	DAM revising letter to opposing counsel re stay of execution of judgement; reviewing documents	0.75

Current Services Rendered for Matter: 4,402.00

Recapitulation

<u>Attorney</u>	<u>Hours</u>	<u>Hourly Rate</u>	<u>Total</u>
Connie B. Berg	0.60	225.00	135.00
F. William McLaughlin	5.05	340.00	1,717.00
Dean A. Monco	7.50	340.00	2,550.00
Photocopies			0.80
Facsimile			3.25
Telephone			0.25
Photocopies			0.20
Facsimile			8.75
Facsimile			4.25
Photocopies			2.40
Facsimile			3.50
Disbursements per Matter Thru 02/28/2003			<u>23.40</u>
CURRENT MONTH TOTAL			4,425.40
Total Matter Balance Due			<u>4,425.40</u>

Wood, Phillips, Katz, Clark & Mortimer
500 West Madison Street
Suite 3800
Chicago, IL 60661
(312) 876-1800
Fax: (312) 876-2020

Peterson Co./Robert H.
2500 W. Arthington
Chicago IL 60612

Page: 1

03/31/2003

Account No: 00742-0008

Statement No: 5220

Attn: Leslie Bortz

GOLDEN BLOUNT, INC. v. ROBERT H. PETERSON CO.

	Hours
03/01/2003 DAM reviewing and organizing documents	0.50
03/04/2003 CBB Maintain litigation docket for Feb. 1-28, 2003	0.60
03/06/2003 DAM preparing forms for submission to Federal Circuit	0.50
03/07/2003 DAM reviewing Federal Circuit Rules for Appeal	1.00
03/10/2003 DAM conferring with Jerry Selinger re payment of fee for Notice of Appeal	0.25
03/11/2003 FWM Review final Order. Research issues of interest and compute estimate. Telephone conference with local counsel. Prepare letter to L. Bortz.	1.50
03/11/2003 DAM revising forms for Federal Circuit; reviewing Order re damages; conferring with Jerry Selinger re Amended Notice of Appeal	1.00
03/12/2003 DAM preparing correspondence to our washington associate re Filing Rules 47 and 48 Forms; preparing certificate of service; reviewing documents from trial	1.50
03/13/2003 FWM Telephone conference with L. Hutchison re bond requirements. Review local court rules re approved surety companies.	0.50
03/13/2003 DAM revising transmittal letter re filing of Rule 47 and 48 Forms; revising forms and assembling for transmission; preparing Certificate of Service; conferring with FWM re supersedeas bond and Rule 62 (d)	2.50

JT-APP 2745

03/14/2003	FWM Prepare letters to W. Harris and L. Bortz re filing of bond.	0.50
03/17/2003	DAM begin reviewing trial transcript	2.00
03/18/2003	DAM reviewing and summarizing trial transcript; research re requirements for appendix and brief	3.00
03/19/2003	DAM reviewing and summarizing trial testimony; reviewing exhibits	2.50
03/20/2003	DAM reviewing and summarizing testimony; reviewing exhibit; conferring with FWM and Lee Hutchinson re: supersedes bond; escrow account	4.50
03/21/2003	DAM reviewing and summarizing trial testimony; reviewing exhibits	4.00
03/22/2003	DAM preparing Rule 30(d) letter re: appendix and issues to opposing counsel; continuing trial testimony review and summary	2.50
03/24/2003	FWM Confer with DAM re appeal. Update docket sheet for appeal.	0.50
03/24/2003	DAM completing review of trial testimony and summary; reviewing exhibits	3.50
03/25/2003	FWM Prepare letter to L. Bortz re deadlines on appeal.	0.50
03/25/2003	DAM reviewing trial exhibits; conferring with FWM re: appendix and appeal briefs	1.50
03/26/2003	FWM Review transcript re exhibit nos. used in trial. Confer with DAM re issues on appeal. Telephone conferences with L. Bortz.	1.50
03/26/2003	DAM reviewing trial exhibits and amending draft letter to opposing counsel re materials for appendix; reviewing and revising trial testimony outline; conferring with FWM	3.50
03/27/2003	DAM conferring with Leland Hutchinson re transition; preparing email re contact information; preparing email to local counsel re payment for appeal; reviewing email from Jennifer Fitzgerald re: materials in her possession and comparing with docket sheet; preparing responsive emails	2.50
03/28/2003	FWM Office conference with L. Hutchinson and J. Fitzgerald re appeal. Prepare letter to local counsel re trial transcript.	2.00
03/28/2003	DAM meeting with Leland Hutchinson and Jennifer Fitzgerald; collecting documents to be copied for transmission; preparing letters to the copying service	2.50

03/31/2003	CBB	Maintain litigation docket for March 2003.	0.75
03/31/2003	DAM	corresponding with local counsel re trial transcript; preparing documents for shipment to copier	1.00

Current Services Rendered for Matter: 16,368.75

Recapitulation

<u>Attorney</u>	<u>Hours</u>	<u>Hourly Rate</u>	<u>Total</u>
Connie B. Berg	1.35	225.00	303.75
F. William McLaughlin	7.00	340.00	2,380.00
Dean A. Monco	40.25	340.00	13,685.00
Photocopies			37.20
Long Distance Telephone			6.25
Facsimile			8.00
Federal Express to Richardson, TX on 02-28-03			12.10
Services and disbursements of Jenkins & Gilchrist for February 2003			435.75
			<u>499.30</u>
			CURRENT MONTH TOTAL
			16,868.05
			Total Matter Balance Due
			<u>16,868.05</u>

Wood, Phillips, Katz, Clark & Mortimer
 500 West Madison Street
 Suite 3800
 Chicago, IL 60661
 (312) 876-1800
 Fax: (312) 876-2020

Peterson Co./Robert H.
 2500 W. Arthington
 Chicago IL 60612

Page: 1
 04/30/2003
 Account No: 00742-0008
 Statement No: 5609

Attn: Leslie Bortz

GOLDEN BLOUNT, INC. v. ROBERT H. PETERSON CO.

	Hours
04/01/2003 DAM preparing documents for shipment to copier; reviewing documents	1.00
04/02/2003 DAM preparing email correspondence to local counsel re transferring form and appearance form; reviewing documents	0.75
04/03/2003 DAM exchanging several emails with Jennifer Fitzgerald re duplication of documents and production of transcripts; reviewing correspondence from opposing counsel re supercedas bond; locating and electronically forwarding copies of transcripts to Jennifer Fitzgerald	2.00
04/07/2003 DAM preparing email to Jennifer Fitzgerald re substitution of counsel at CAFC; refileing documents	0.75
04/07/2003 JSM Confer with DAM re appeal strategy.	0.75
Current Services Rendered for Matter:	<u>1,785.00</u>

Recapitulation

<u>Attorney</u>	<u>Hours</u>	<u>Hourly Rate</u>	<u>Total</u>
Dean A. Monco	4.50	340.00	1,530.00
John S. Mortimer	0.75	340.00	255.00
Photocopies			0.40
Facsimile			4.50
Federal Express to Dallas, TX on 03-28-03			11.02
Federal Express to Arlington, VA on 03-13-03			11.97

Services and disbursements of Jenkins & Gilchrist for March 2003	710.08
outlay to Aro Business Services for photocopies and supplies	445.58
Services and disbursements of our Arlington, VA associate for trip to the CAFC to obtain current Rules and Practice, and forms; and forward on March 3, 2003.	143.00
Services and disbursements of our Arlington, VA associate re trip to the CAFC on March 14, 2003 to file the Entry of Appearance and Certificate of Interest for Defendant-Appellant Robert H. Peterson Co. along with the Certificate of Service; and return the date-stamped two copies of each document for our records.	125.00
Disbursements per Matter Thru 04/30/2003	<u>1,451.55</u>
CURRENT MONTH TOTAL	3,236.55
Total Matter Balance Due	<u>3,236.55</u>

JT-APP 2749

Wood, Phillips, Katz, Clark & Mordmer
 500 West Madison Street
 Suite 3800
 Chicago, IL 60661
 (312) 876-1800
 Fax: (312) 876-2020

Peterson Co./Robert H.
 2500 W. Arthington
 Chicago IL 60612

Page: 1
 05/31/2003
 Account No: 00742-0008
 Statement No: 5744

Attn: Leslie Bortz
 GOLDEN BLOUNT, INC. v. ROBERT H. PETERSON CO.

	Hours
05/08/2003	
DAM locating and forwarding transcripts requested by Jennifer Fitzgerald; conferring several times with Freeborn & Peters paralegal re requested documents	1.00
05/09/2003	
DAM conferring with Jennifer Fitzgerald re evidence of infringement; preparing emails to FWM and Jennifer Fitzgerald	1.00
05/15/2003	
FWM Confer with N. Keough of Freeborn & Peters and review files and transcripts. Confer with J. Coppess re exhibits and review exhibits.	1.00
Current Services Rendered for Matter:	1,020.00

Recapitulation

<u>Attorney</u>	<u>Hours</u>	<u>Hourly Rate</u>	<u>Total</u>
F. William McLaughlin	1.00	340.00	340.00
Dean A. Monco	2.00	340.00	680.00
Photocopies			144.00
Disbursements per Matter Thru 05/31/2003			144.00
CURRENT MONTH TOTAL			1,164.00
Total Matter Balance Due			1,164.00

Wood, Phillips, Katz, Clark & Mortimer
600 West Madison Street
Suite 3800
Chicago, IL 60661
Telephone: (312) 876-1800
Fax: (312) 876-2020

Peterson Co./Robert H.
2500 W. Arthington
Chicago IL 60612

Page: 1
08/31/2003
Account No: 00742-0008
Statement No: 6705

Attn: Leslie Bortz

GOLDEN BLOUNT, INC. v. ROBERT H. PETERSON CO.

07/07/2003

FWM Confer with J. Coppess. Review files and forward copy of Protective Order for Appendix

Current Services Rendered for Matter:	<u>170.00</u>
CURRENT MONTH TOTAL	170.00
Total Matter Balance Due	<u>170.00</u>

Past Due Amounts			
<u>0-30</u>	<u>31-60</u>	<u>61-90</u>	<u>91-120</u>
0.00	173.45	0.00	127,373.32

Disbursements incurred not appearing on this statement
will be billed at a later time.

JT-APP 2751

Attorneys' Fees Expended By Wood Phillips Firm

Name of Firm	Attorney Billing Rate	Total Fees For Firm
Wood, Phillips, Katz, Clark & Mortimer	\$320/hr. – applied until 01/03 \$340/hr. – applied after 01/03	\$271,839.25

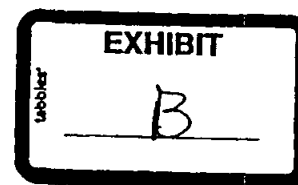

Disbursement Relating to Wood Phillips Firm

Type of Disbursement	Amount
Postage	\$33.19
Long distance phone	\$230.06
Photocopies	\$2,876.45
Travel	\$5,350.59
Express Mail Charges	\$616.10
Local Messenger Delivery	\$25.00
Paralegals	\$4,228.07
Computerized Legal Research	\$450.33
Facsimiles	\$266.02
TOTAL	\$14,075.81

JT-APP 2753



CERTIFICATE OF SERVICE

This certifies that a copy of the foregoing document was served by first-class mail, postage prepaid, to counsel for Plaintiff, William D. Harris, Jr., Schultz & Associates, P.C., 5400 LBJ Freeway, One Lincoln Center, Suite 525, Dallas, Texas 75240. and Charles Gaines, Hitt Gaines, P.C., 2435 North Central Plaza, Suite 1300, Richardson, Texas 75080, this 22nd day of July, 2004.

Glenn Parker

IN THE UNITED STATES DISTRICT COURT
NORTHERN DISTRICT OF TEXAS
DALLAS DIVISION

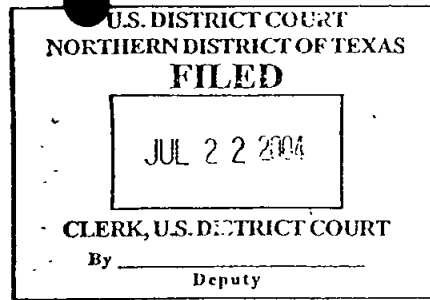

GOLDEN BLOUNT, INC.

Plaintiff,

v.

ROBERT H. PETERSON CO.

Defendant.

§
§
§
§
§
§
§
§

Civil Action No. 3-01CV0127-R

(JURY TRIAL DEMANDED)

**DECLARATION OF LELAND W. HUTCHINSON, JR. IN SUPPORT OF
DEFENDANT ROBERT H. PETERSON'S APPLICATION FOR ATTORNEYS' FEES**

1. I, Leland W. Hutchinson, Jr., am a partner with the firm of FREEBORN & PETERS LLP and have since August 2002 represented Robert H. Peterson Co. in the above referenced litigation.

2. I have been lead counsel for Robert H. Peterson throughout the appeal of this case and in the proceedings upon remand to this Court.

3. This case is a patent infringement case that presents numerous substantial and complex issues including, but not limited to, actual infringement, contributory infringement, induced infringement, infringement under the doctrine of equivalents, willfulness, measurement of damages and the award of attorneys' fees.

4. Since the beginning of my involvement in the case, I and my colleagues have handled on behalf of our client review of the file to familiarize ourselves with the facts, drafting of the initial appellate brief, drafting of the reply in support of appeal, appellate argument,

preparation of Proposed Findings of Facts and Conclusions of Law on remand before this Court and drafting of all post-trial motions and memoranda.

5. Attached hereto as Exhibit A are true and correct copies of the invoices that have been provided to Peterson representing the attorney's fees for representation in this case.

6. As these invoices indicate, Freeborn & Peters has used a team of primarily three or four attorneys on this case. In general, tasks were divided based on the skill and experience of the attorneys and all worked on a collaborative final product.

7. Primarily three Freeborn & Peters attorneys have worked on this matter: myself, Jennifer Fitzgerald and David Becker. My billing rate was originally \$395 per hour which was later raised to \$425 per hour; Ms. Fitzgerald's billing rate was originally \$295 per hour which was later raised to \$325 per hour; and Mr. Becker's billing rate was originally \$195 per hour which was later raised to \$225 per hour. The billing rates for all attorneys involved in this case are outlined in the table attached hereto as Exhibit B. All rates charged applied in this case are consistent with the rates charged by my firm to other clients comparable to Peterson.

8. I have reviewed plaintiff's application for attorneys' fees which was filed after the initial judgment in this case. In reviewing that document, I noted that plaintiff's counsel's billing rate is \$350 per hour which, other than my billing rate, is higher than all other Freeborn & Peters attorneys' rates.

9. In total, my firm has expended 807 attorney hours totaling \$234,729.00 in attorney fees. Attached hereto as Exhibit B is a summary table indicating the hours and billing rates of all Freeborn & Peters attorneys involved in this case.

10. I am familiar with the customary fees for this type of litigation charged in large legal markets such as Chicago and Dallas. In my opinion, the hours billed by myself and other

members of my firm are reasonable in relation to the quantity and substance of the representation in this case. I further understand the hourly rates for the attorneys in my firm to reasonable in relation to other similar attorneys in large markets such as Dallas and Chicago.

11. I have reviewed the bills and do not believe that there was significant duplication of effort among the members of my firm or the other firms representing my client.

12. It is my opinions that the total value and effort by FREEBORN & PETERS was reasonable and necessary for proper defense of this case.

13. Attached as Exhibit C is a summary table indicating the disbursements and out-of-pocket expenses incurred during the course of this case.

14. In total, my firm has disbursed \$39,413.83 for postage, long distance calls, xeroxing, travel, air express delivery, local messenger delivery, paralegals, computerized legal research and facsimiles.

15. In total Peterson is seeking \$274,142.83 in fees and disbursement for Freeborn & Peters.

I declare under penalty of perjury under the laws of the United States of America that the foregoing is true and correct to the best of my knowledge and belief.

Executed July 22, 2004, at Chicago, Illinois.

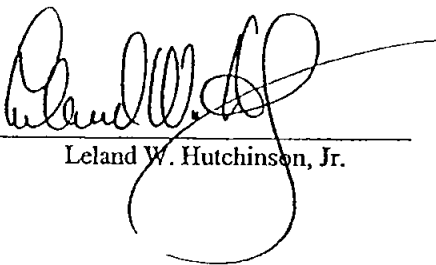

Leland W. Hutchinson, Jr.

Freeborn & Peters
October 18, 2002

FEIN #36-3238755

Mr. Leslie Bortz
R.H. Peterson
2500 W. Arthington Street
Chicago, IL 60612

COPY

Statement No. 99714390

Attorneys at Law

1 South Wacker Drive
Suite 3000
Chicago, Illinois 60606-6677
1312.360.6000

Re: Patent
Client Matter ID No. 22148-0003

FOR PROFESSIONAL SERVICES RENDERED AND EXPENSES INCURRED
THROUGH SEPTEMBER 30, 2002:

FEES FOR THIS STATEMENT	\$7,858.00
DISBURSEMENTS	<u>650.64</u>
TOTAL AMOUNT OF CURRENT STATEMENT	8,508.64
BALANCE DUE	<u>\$8,508.64</u>

Chicago

Springfield

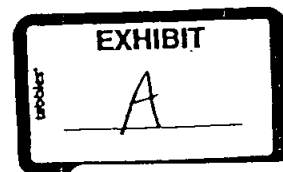

JT-APP 2758

Freeborn & Peters

October 18, 2002

2

Statement No: 99714390

For professional services rendered with regard to:

Re: Patent

Sep 3, 2002	JS	Call from Leslie regarding lease and precor.	0.30
Sep 4, 2002	JS	Call from Leslie to Jennifer.	0.80
Sep 5, 2002	JF	Attention to status; exchange of correspondence with Wood Phillips; office conferences with John Stiefel regarding status; office conference with Lee Hutchinson regarding the same; review of motions filed by Golden Blount.	1.20
Sep 6, 2002	JS	Call Leslie regarding suit.	0.30
Sep 9, 2002	JS	Two calls from Leslie regarding golden case.	0.80
Sep 12, 2002	JS	Call Leslie regarding Harris billing, etc.	0.30
Sep 12, 2002	JF	Review of post trial motions; preparation of responses.	0.40
Sep 13, 2002	LWH	Conference with Jennifer Fitzgerald regarding post trial motions.	0.50
Sep 13, 2002	JF	Office conference with Lee Hutchinson regarding intellectual property issues.	0.20
Sep 16, 2002	TH	Office conference with Jennifer Fitzgerald regarding case background and strategy, review Peterson Company's Objections to Plaintiff's Claim for Attorney's Fees, and research Federal case law regarding the calculation of attorney's fees.	2.10
Sep 16, 2002	JS	Calls with Leslie, Jennifer regarding reply to pl petitions for fees.	0.80
Sep 16, 2002	LWH	Conference regarding attorneys fees response.	0.50
Sep 16, 2002	JF	Review of draft response to request for attorney fees; office conferences with Lee Hutchinson and Tyra Holt regarding the same.	0.80

JT-APP 2759

Freeborn & Peters

3

October 18, 2002

Sep 17, 2002	TH	Office conference with Jennifer Fitzgerald regarding case background and research assignment, research awarding attorneys fees when the description of attorney's time is inadequate, what qualifies as inadequate description, the reasonable rate of photocopying, awarding travel expenses for attorney travel to depositions, Shepardize case law (Johnson and In re Dahlgren), analyze case law research and draft memorandum of research.	5.80
Sep 17, 2002	JS	Call from Leslie regarding damage issue, filing deadlines, returns credit against sales, etc.	0.50
Sep 17, 2002	JF	Legal research and review regarding attorney fee awards; telephone conference with Leslie Bortz; office conferences with Tyra Holt regarding legal research; legal research regarding attorney fee issues; office conferences with John Stiefel and Lee Hutchinson regarding status; exchange of correspondence with Wood Phillips regarding responses and comments; draft memorandum with comments to attorney fees response.	5.40
Sep 18, 2002	TH	Continue to research Federal case law regarding prejudgment and post judgment interest and if the court can grant the interest on the treble damages and if the court can grant interest on attorney's fees.	0.90
Sep 18, 2002	LWH	Conference regarding post trial motions in case; review emails.	0.60
Sep 18, 2002	JF	Review of legal research from Tyra Holt; exchange messages with John Stiefel regarding status and strategy; legal research regarding damages calculations; office conference with Tyra Holt regarding additional research on post judgment interest; review of facsimile from Leslie Bortz; update Mr. Bortz on status; exchange messages with Dean Monco regarding draft briefs; office conference with Lee Hutchinson regarding briefs; telephone conference with Leslie Bortz.	4.70
Sep 19, 2002	TH	Research, review, and analyze Federal case law regarding if damages can be offset if items are returned instead of sold.	1.20
Sep 19, 2002	JF	Review and revise post trial response brief drafts from Wood Phillips; legal research regarding the same; office conference with Lee Hutchinson.	2.70

JT-APP 2760

Freeborn & Peters

October 18, 2002

4

Sep 23, 2002	JF	Office conference with Lee Hutchison; draft e-mail regarding negotiating position of X-BOX ENCLOSURES.	0.20
Sep 23, 2002	JF	Telephone conference with Bill McLaughlin and Dean Monco regarding agreement with Gains to review unredacted time records; office conference with Lee Hutchinson regarding the same; correspond with McLaughlin and Monco regarding discussion with Lee.	0.40
Sep 24, 2002	JF	Review of legal research regarding attorney client privilege and redacted time records.	0.20

FEE SUMMARY

<u>TIMEKEEPER</u>	<u>HOURS</u>	<u>RATE</u>	<u>FEES</u>
Fitzgerald, Jennifer L.	16.20	275.00	\$4,455.00
Stiefel, John C.	3.80	295.00	\$1,121.00
Holt, Tyra	10.00	165.00	\$1,650.00
Hutchinson, Leland W.	1.60	395.00	\$632.00
TOTAL HOURS	31.60		
TOTAL FEES			<u>\$7,858.00</u>

DISBURSEMENT SUMMARY

Local Messenger Delivery	20.75
Photocopying	116.40
Computer Legal Research - Westlaw	513.49
TOTAL DISBURSEMENTS	<u>\$650.64</u>
TOTAL FEES AND DISBURSEMENTS	<u>\$8,508.64</u>

Freeborn & Peters
October 18, 2002

FEIN #36-3238755

Mr. Leslie Bortz
R.H. Peterson
2500 W. Arthington Street
Chicago, IL 60612

COPY

Attorneys at Law

11 South Wacker Drive
Suite 3000
Chicago, Illinois 60606-6677
Tel 312.360.6000

Statement No. 99716814

Re: Patent
Client Matter ID No. 22148-0003

FOR PROFESSIONAL SERVICES RENDERED AND EXPENSES INCURRED
THROUGH AUGUST 31, 2002:

FEES FOR THIS STATEMENT	\$21,221.00
DISBURSEMENTS	<u>938.36</u>
TOTAL AMOUNT OF CURRENT STATEMENT	22,159.36
BALANCE DUE	<u>\$22,159.36</u>

PAYMENT DUE UPON RECEIPT.
INTEREST OF 1.5% PER MONTH WILL BE ADDED AFTER 30 DAYS.

JT-APP 2762

Freeborn & Peters

October 18, 2002

2

Statement No: 99716814

For professional services rendered with regard to:

Re: Patent

Aug 13, 2002	JS	Call Leslie regarding patent case.	0.30
Aug 14, 2002	JS	Call Leslie regarding patent trial.	0.30
Aug 15, 2002	JS	Call from Leslie regarding patent case; conference with Lee Hutchinson; call Bortz with Lee.	1.00
Aug 15, 2002	JWC	Met with Jennifer Fitzgerald for conference introducing me to the patent litigation.	0.20
Aug 15, 2002	JF	Office conference with Lee Hutchinson and Jon Coppess regarding status and strategy for post trial motions.	0.40
Aug 15, 2002	LWH	Conference with John Stiefel; telephone conferences with Leslie Bortz.	0.80
Aug 16, 2002	JS	Calls to Leslie regarding patent suit; conference with Lee and Jennifer; call wood attorney.	1.00
Aug 16, 2002	JWC	Research regarding whether a Markman Hearing is required in all patent infringement cases.	1.90
Aug 16, 2002	JF	Legal research regarding patent issues; Markman hearings and damages; office conferences with Lee Hutchinson and Jon Coppess regarding research issues; telephone conference with John Stiefel, Lee Hutchinson and Leslie Bortz regarding status and strategy; review of patents.	4.40
Aug 16, 2002	LWH	Conference regarding appeal issues; telephone conference with Leslie Bortz.	2.30
Aug 17, 2002	JF	Review of patent and trial transcript.	3.20
Aug 17, 2002	LWH	Read transcripts and patents regarding review of trial proceedings.	4.30
Aug 18, 2002	JF	Review of patent and trial transcript.	5.50
Aug 18, 2002	LWH	Read transcripts and patents regarding review of trial proceedings.	3.20
Aug 19, 2002	LWH	Meet with patent counsel; telephone conferences regarding case; review documents and transcripts.	2.20

JT-APP 2763

Aug 19, 2002	JWC	Research regarding willful infringement of patent rights and whether a written attorney opinion letter is required to avoid a finding of willful infringement; began draft of memo regarding the research.	6.10
Aug 19, 2002	JF	Preparation for and attendance at meeting at Wood Phelps with Lee Hutchinson regarding post trial motions; meeting with Dean Monco and William McLaughlin and Lee Hutchinson regarding post trial motions and appeal issues; office conference with Jon Coppess regarding willful infringement standards; review of trial transcripts.	9.70
Aug 20, 2002	JS	Meeting with Leslie Bortz, Lee Hutchinson and Jennifer Fitzgerald.	3.00
Aug 20, 2002	LWH	Meet with Leslie Bortz regarding case; prepare for same.	2.40
Aug 20, 2002	JWC	Continue draft of memo regarding the research of the necessity of having a written attorney opinion letter in attempts to avoid finding of willful infringement.	1.50
Aug 20, 2002	JF	Meeting with Lee Hutchinson regarding status and strategy; telephone conference with Dean Monco and Lee Hutchinson regarding post trial motions; preparation for meeting with Leslie Bortz; meeting with John Stiefel, Leslie Bortz and Lee Hutchinson; review of Leslie Bortz deposition transcript.	5.60
Aug 21, 2002	LWH	Telephone conferences with client; review motions; make changes to same.	1.10
Aug 21, 2002	JF	Review of Leslie Bortz deposition transcript and documents; meeting with Lee Hutchinson regarding deposition transcripts and post trial motions; telephone conference with Dean Monco regarding post trial motions; telephone conference with Leslie Bortz regarding post trial motions; review of documents prepared by Leslie Bortz; preparation of trial transcript for Leslie Bortz; review draft motion from Wood Philips; review opinion letter regarding the G44 Burner.	5.40
Aug 22, 2002	JS	Review press release; call Leslie.	0.30
Aug 22, 2002	LWH	Conference regarding post-trial motions; edit same; edit and discuss press release.	1.60

Freeborn & Peters

4

October 18, 2002

Aug 22, 2002	JF	Meeting with Lee Hutchinson regarding post trial motions; review and revise motion; telephone conference with Dean Monco regarding the same.	0.90
Aug 23, 2002	JS	Call Leslie regarding new opinion letter; other matters.	0.80
Aug 23, 2002	JF	Review of memorandum regarding post trial motions; exchange voicemail messages with Leslie Bortz; telephone conference with Leslie Bortz regarding status.	0.40
Aug 26, 2002	JS	call from Bortz; call Lee regarding request for proof of sales.	0.50
Aug 26, 2002	JF	Office conference with Lee Hutchinson regarding sales figures and motion to amend fee award; exchange of correspondence with Wood Philips regarding post trial motions.	0.20
Aug 27, 2002	JF	Review of post trial motions and memoranda.	0.40
Aug 28, 2002	JS	Call from Leslie regarding today's messages.	0.40
Aug 28, 2002	JS	Call from Lee, to Leslie regarding production of documents.	0.30
Aug 28, 2002	LWH	Telephone conference regarding Rule 52.	0.60
Aug 30, 2002	JF	Office conference with Lee Hutchinson regarding Golden Blount post trial motions.	0.20

FEE SUMMARY

<u>TIMEKEEPER</u>	<u>HOURS</u>	<u>RATE</u>	<u>FEES</u>
Fitzgerald, Jennifer L.	36.30	275.00	\$9,982.50
Stiefel, John C.	7.90	295.00	\$2,330.50
Coppess, Jonathan W.	9.70	165.00	\$1,600.50
Hutchinson, Leland W.	18.50	395.00	\$7,307.50
TOTAL HOURS	72.40		
TOTAL FEES			<u>\$21,221.00</u>

Freeborn & Peters

October 18, 2002

5

DISBURSEMENT SUMMARY

Computer Legal Research - Westlaw	833.86
Telephone	3.90
Photocopying	100.60
TOTAL DISBURSEMENTS	<u>\$938.36</u>
TOTAL FEES AND DISBURSEMENTS	\$22,159.36

495757

JT-APP 2766

Freeborn & Peters

November 13, 2002

FEIN #36-3238755

Mr. Leslie Bortz
R.H. Peterson
2500 W. Arthington Street
Chicago, IL 60612

COPY

Attorneys at Law

Statement No. 99718275

11 South Wacker Drive
Suite 3000
Chicago, Illinois 60606-6677
tel 312.360.6000

Re: Patent
Client Matter ID No. 22148-0003

FOR PROFESSIONAL SERVICES RENDERED AND EXPENSES INCURRED
THROUGH OCTOBER 31, 2002:

Chicago

FEES FOR THIS STATEMENT \$728.50

Springfield

DISBURSEMENTS 0.77

TOTAL AMOUNT OF CURRENT STATEMENT 729.27

BALANCE DUE \$729.27

PAYMENT DUE UPON RECEIPT.
INTEREST OF 1.5% PER MONTH WILL BE ADDED AFTER 30 DAYS.

JT-APP 2767

Freeborn & Peters

November 13, 2002

2

Statement No: 99718275

For professional services rendered with regard to:

Re: Patent

Oct 3, 2002	LWH	Review brief and telephone conference regarding same.	0.80
Oct 7, 2002	JF	Review of correspondence from Wood Phillips.	1.10
Oct 9, 2002	JF	Telephone conference with Leslie Bortz regarding reply motions and responses.	0.40

FEE SUMMARY

<u>TIMEKEEPER</u>	<u>HOURS</u>	<u>RATE</u>	<u>FEES</u>
Fitzgerald, Jennifer L.	1.50	275.00	\$412.50
Hutchinson, Leland W.	0.80	395.00	\$316.00
TOTAL HOURS	2.30		
TOTAL FEES			<u>\$728.50</u>

DISBURSEMENT SUMMARY

Other Outside Services	0.77
TOTAL DISBURSEMENTS	<u>\$0.77</u>
TOTAL FEES AND DISBURSEMENTS	<u>\$729.27</u>

500093

JT-APP 2768

Freeborn & Peters

January 20, 2003

FEIN #36-3238755

Mr. Leslie Bortz
R.H. Peterson
2500 W. Arthington Street
Chicago, IL 60612

COPY

Attorneys at Law

Statement No. 99725068

1 South Wacker Drive
Suite 3000
Chicago, Illinois 60606-6677
412.360.6000

Re: Patent
Client Matter ID No. 22148-0003

FOR PROFESSIONAL SERVICES RENDERED AND EXPENSES INCURRED
THROUGH DECEMBER 31, 2002:

Chicago

Springfield

FEES FOR THIS STATEMENT	\$88.50
DISBURSEMENTS	<u>0.00</u>
TOTAL AMOUNT OF CURRENT STATEMENT	88.50
BALANCE DUE	<u>\$88.50</u>

**PAYMENT DUE UPON RECEIPT.
INTEREST OF 1.5% PER MONTH WILL BE ADDED AFTER 30 DAYS.**

JT-APP 2769

Statement No: 99725068

For professional services rendered with regard to:

Re: Patent

Dec 9, 2002	JS	Conference with Leslie regarding patent suit; call to Jennifer.	0.30
-------------	----	---	------

FEE SUMMARY

<u>TIMEKEEPER</u>	<u>HOURS</u>	<u>RATE</u>	<u>FEES</u>
Stiefel, John C.	0.30	295.00	\$88.50
TOTAL HOURS	0.30		
TOTAL FEES			<u>\$88.50</u>
TOTAL FEES AND DISBURSEMENTS			\$88.50

Freeborn & Peters

March 18, 2003

FEIN #36-3238755

Mr. Leslie Bortz
R.H. Peterson
2500 W. Arthington Street
Chicago, IL 60612

COPY

Attorneys at Law

South Wacker Drive
Chicago, Illinois 60606-6677
312.360.6000

Statement No. 99730949

Re: Patent
Client Matter ID No. 22148-0003

FOR PROFESSIONAL SERVICES RENDERED AND EXPENSES INCURRED
THROUGH FEBRUARY 28, 2003:

Chicago	FEEs FOR THIS STATEMENT	\$1,075.00
Springfield	DISBURSEMENTS	<u>0.80</u>
	TOTAL AMOUNT OF CURRENT STATEMENT	1,075.80
	BALANCE DUE	<u>\$1,075.80</u>

PAYMENT DUE UPON RECEIPT.
INTEREST OF 1.5% PER MONTH WILL BE ADDED AFTER 30 DAYS.

JT-APP 2771

Freeborn & Peters

March 18, 2003

2

Statement No: 99730949

For professional services rendered with regard to:

Re: Patent

Feb 19, 2003	JS	Call from Leslie; conference with Lee; call Leslie regarding appeal.	0.80
Feb 19, 2003	LWH	Conference, telephone conference and send letter.	0.60
Feb 19, 2003	JF	Review order; office conference with Lee Hutchinson regarding the same.	0.30
Feb 21, 2003	LWH	Attention to appeal issues.	0.70
Feb 24, 2003	LWH	Attention to appeal issues.	0.60

FEE SUMMARY

<u>TIMEKEEPER</u>	<u>HOURS</u>	<u>RATE</u>	<u>FEES</u>
Fitzgerald, Jennifer L.	0.30	295.00	\$88.50
Stiefel, John C.	0.80	295.00	\$236.00
Hutchinson, Leland W.	1.90	395.00	\$750.50
TOTAL HOURS	3.00		
TOTAL FEES			<u>\$1,075.00</u>

DISBURSEMENT SUMMARY

Photocopying	0.80
TOTAL DISBURSEMENTS	<u>\$0.80</u>
TOTAL FEES AND DISBURSEMENTS	\$1,075.80

523366

JT-APP 2772

Freeborn & Peters

April 16, 2003

FEIN #36-3238755

Mr. Leslie Bortz
R.H. Peterson
C/o Carylon Corp.
2500 W. Arthington Street
Chicago, IL 60612

COPY

Attorneys at Law

1 South Wacker Drive
Suite 3000
Chicago, Illinois 60606-6677
1312.360.6000

Statement No. 99735573

Re: Patent
Client Matter ID No. 22148-0003

FOR PROFESSIONAL SERVICES RENDERED AND EXPENSES INCURRED
THROUGH MARCH 31, 2003:

Chicago

Springfield

FEEES FOR THIS STATEMENT	\$5,976.00
DISBURSEMENTS	<u>2.00</u>
TOTAL AMOUNT OF CURRENT STATEMENT	5,978.00
BALANCE DUE	<u>\$5,978.00</u>

*PAYMENT DUE UPON RECEIPT.
INTEREST OF 1.5% PER MONTH WILL BE ADDED AFTER 30 DAYS.*

JT-APP 2773

Statement No: 99735573

For professional services rendered with regard to:

Re: Patent

Mar 10, 2003	LWH	Conference call regarding appeal.	0.60
Mar 13, 2003	JS	Calls from/to Leslie rearding appeal and bond.	0.50
Mar 13, 2003	LWH	Research and telephone calls regarding bonds and appeal.	0.70
Mar 17, 2003	LWH	Telephone conferences regarding bond issues.	0.70
Mar 20, 2003	LWH	Telephone conferences regarding escrow agreement.	0.80
Mar 24, 2003	LWH	Attention to escrow issues; patent issues; telephone conferences regarding appeal.	0.80
Mar 25, 2003	JS	Conference call with Leslie and Marci; conference with Lee and conference call with Lee and Leslie.	0.80
Mar 25, 2003	LWH	Telephone conference regarding patent issues; review local rules.	1.40
Mar 26, 2003	LWH	Telephone conferences regarding appeal.	0.90
Mar 27, 2003	LWH	Telephone conference with Leslie Bortz.	0.60
Mar 27, 2003	JF	Meeting with Lee Hutchinson regarding status and strategy; review of correspondence from Wood Phillips; review of local and federal rules regarding filings; telephone call to Charles Gaines regarding appending; draft correspondence to Wood Phillips; telephone conference with Charles Gaines, Bill Harris and Greg Parker regarding status and extension.	2.70
Mar 28, 2003	LWH	Meet with former counsel; telephone conferences regarding same.	2.30
Mar 28, 2003	JF	Draft correspondence to Charles Gaines, Bill Harris and Greg Parker confirming our agreement to an extension; preparation for and attendance at meeting with Bill McLaughlin and Dean Monco and Lee Hutchinson.	2.60
Mar 31, 2003	LWH	Attention to appeal issues.	1.40

FEE SUMMARY

<u>TIMEKEEPER</u>	<u>HOURS</u>	<u>RATE</u>	<u>FEES</u>
Fitzgerald, Jennifer L.	5.30	295.00	\$1,563.50

Freeborn & Peters

April 16, 2003

3

<u>TIMEKEEPER</u>	<u>HOURS</u>	<u>RATE</u>	<u>FEES</u>
Stiefel, John C.	1.30	295.00	\$383.50
Hutchinson, Leland W.	10.20	395.00	\$4,029.00

TOTAL HOURS 16.80

TOTAL FEES \$5,976.00

DISBURSEMENTS

Mar 28, 2003	FIRM	Facsimile 972 4808865	2.00
--------------	------	--------------------------	------

DISBURSEMENT SUMMARY

Facsimile	2.00
TOTAL DISBURSEMENTS	<u>\$2.00</u>

TOTAL FEES AND DISBURSEMENTS \$5,978.00

#529559

c:\bills\246436.bil

JT-APP 2775

Freeborn & Peters

May 23, 2003

FEIN #36-3238755

COPY

Mr. Leslie Bortz
R.H. Peterson
2500 W. Arthington Street
Chicago, IL 60612

Attorneys at Law

311 South Wacker Drive
Suite 3000
Chicago, Illinois 60606-6677
Tel 312.360.6000

Statement No. 99738669

Re: Patent
Client Matter ID No. 22148-0003

FOR PROFESSIONAL SERVICES RENDERED AND EXPENSES INCURRED
THROUGH APRIL 30, 2003:

Chicago

Springfield

FEES FOR THIS STATEMENT	\$17,235.00
DISBURSEMENTS	<u>3,232.95</u>
TOTAL AMOUNT OF CURRENT STATEMENT	20,467.95
BALANCE DUE	<u>\$20,467.95</u>

*PAYMENT DUE UPON RECEIPT.
INTEREST OF 1.5% PER MONTH WILL BE ADDED AFTER 30 DAYS.*

JT-APP 2776

Statement No: 99738669

For professional services rendered with regard to:

Re: Patent

Apr 1, 2003	DSB	Legal research regarding notice of infringement in relation to damages; office conference with Jennifer Fitzgerald regarding case overview strategy.	3.70
Apr 1, 2003	JF	Meeting with David Becker regarding case, appeal and legal research issues.	0.40
Apr 2, 2003	DSB	Review cases related to notice of infringement issue; office conference with Jennifer Fitzgerald regarding same.	0.90
Apr 2, 2003	JWC	Began research regarding Patent law and the invalidating effect of prior art.	2.20
Apr 2, 2003	JF	Meeting with John Coppess regarding case and legal research; meeting with David Becker regarding legal research status and facts.	0.50
Apr 3, 2003	JF	Attention to transfer of files; review of case law.	0.20
Apr 4, 2003	JWC	Continue research regarding patent issues of prior art, interpretation in a crowded field and inequity/fraud on the Patent Office.	3.30
Apr 5, 2003	JWC	Continue research of patent issues.	3.00
Apr 6, 2003	JWC	Continue research of patent issues.	3.00
Apr 7, 2003	JWC	Continue research of patent issues regarding invalidity, crowded art field and inequitable conduct before the PTO.	5.40
Apr 7, 2003	JF	Review of trial transcripts.	1.20
Apr 8, 2003	JWC	Continue research regarding patent law issues of invalidity, crowded art field and inequitable conduct before the PTO.	9.60
Apr 9, 2003	JF	Review trial transcripts; office conferences with Lee Hutchinson and David Becker regarding legal research and appeal issues; review of statutes regarding notice provisions.	2.90
Apr 10, 2003	LWH	Attention to escrow and appeal issues.	1.70
Apr 11, 2003	LWH	Review transcript.	1.40
Apr 11, 2003	JWC	Continue research regarding patent issues of invalidity and inequitable conduct before the PTO.	4.40
Apr 14, 2003	JWC	Complete research regarding patent issues of invalidity and fraud on the PTO.	5.80

Apr 15, 2003	LWH	Review exhibits regarding issue identification; conference regarding case.	1.60
Apr 15, 2003	JF	Telephone conference with Charles Gains regarding status and exchange of documents and materials, escrow agreement.	0.20
Apr 16, 2003	LWH	Conference regarding appeal issues and designations; appearances.	2.90
Apr 16, 2003	JF	Review of files in preparation of record on appeal; office conference with Lee Hutchinson regarding letter to Hitt Gaines regarding record on appeal; review of court rules; draft letter to Hitt Gaines regarding appendix contents; review of exhibits.	4.20
Apr 17, 2003	JF	Review and revise letter to Hitt Gaines; draft attachment; review of pleadings for inclusion into record on appeal; office conference with Lee Hutchinson regarding the same.	2.30
Apr 18, 2003	LWH	Attention to appeal issues; review file.	1.70
Apr 24, 2003	DSB	Review case file; obtain local rule for federal circuit; office conference with Jennifer Fitzgerald regarding appellate brief; review trial transcript.	5.40
Apr 24, 2003	JF	Meeting with David Becker regarding preparation of appeal brief; review of issues and outline of brief; review of various pleadings and exhibits.	0.80
Apr 25, 2003	DSB	Review trial transcript.	2.60
Apr 25, 2003	JF	Attention to research issues and use of a product that actually infringes or could be used to infringe; office conference with Lee Hutchinson regarding the same; legal research regarding updates in infringement; telephone conference with Charles Gaines regarding bond issues.	0.70
Apr 29, 2003	JF	Review of papers from federal district court; office conference with David Becker regarding the same.	0.20
Apr 30, 2003	JWC	Research regarding procedural issues for filing motion to substitute security for Appeal to the Federal Circuit from decision by the Northern District of Texas.	1.00
Apr 30, 2003	JF	Office conference with David Becker regarding appeal brief, placement of bond and legal research; review of legal research.	0.40

Freeborn & Peters

May 23, 2003

4

FEE SUMMARY

<u>TIMEKEEPER</u>	<u>HOURS</u>	<u>RATE</u>	<u>FEES</u>
Fitzgerald, Jennifer L.	14.00	295.00	\$4,130.00
Becker, David S.	12.60	195.00	\$2,457.00
Coppess, Jonathan W.	37.70	185.00	\$6,974.50
Hutchinson, Leland W.	9.30	395.00	\$3,673.50
TOTAL HOURS	73.60		
TOTAL FEES			<u>\$17,235.00</u>

DISBURSEMENTS

Mar 18, 2003	BL	Local Messenger Delivery LaSalle Bank 5876-958	5.50
Apr 1, 2003	BM	Other Outside Services VENDOR: LexisNexis CourtLink, Inc.; INVOICE#: EA100219; DATE: 4/1/03	8.70
Apr 2, 2003	JWC	03/03 Courtlink online docket charges Computer Legal Research - Westlaw 04/03 Westlaw Charges	151.59
Apr 4, 2003	JWC	Computer Legal Research - Westlaw 04/03 Westlaw Charges	236.53
Apr 4, 2003	JWC	Computer Legal Research - Westlaw 04/03 Westlaw Charges	745.90
Apr 7, 2003	JWC	Computer Legal Research - Westlaw 04/03 Westlaw Charges	465.63
Apr 8, 2003	JWC	Computer Legal Research - Westlaw 04/03 Westlaw Charges	392.10
Apr 9, 2003	FIRM	Photocopying	75.60
Apr 11, 2003	JWC	Computer Legal Research - Westlaw 04/03 Westlaw Charges	219.70
Apr 14, 2003	JWC	Computer Legal Research - Westlaw 04/03 Westlaw Charges	346.13
Apr 15, 2003	FIRM	Photocopying	157.20
Apr 16, 2003	KDP	Telephone 202 6336550	0.06
Apr 17, 2003	KDP	Telephone 202 6336550	0.18

JT-APP 2779

Freeborn & Peters

May 23, 2003

5

Apr 17, 2003	FIRM	Facsimile 972 4808865	9.00
Apr 17, 2003	JF	Air Express Delivery Clerk's Office 96570	12.08
Apr 25, 2003	FIRM	Photocopying	136.20
Apr 25, 2003	DSB	Other Fees VENDOR: Clerk of the U.S. Court of Appeals; INVOICE#: STMT04/25/03; DATE: 4/25/03 Fee for admission to the Bar of the U.S. Court of Appeals for D. Becker	25.00
Apr 30, 2003	JF	Local Transportation VENDOR: Fitzgerald, Jennifer; INVOICE#: 043003; DATE: 4/30/03 03/28 Cab fare to meeting with Dean Monco	5.00
May 7, 2003	DSB	Computer Legal Research - Westlaw 05/03 Westlaw Charges	240.85

DISBURSEMENT SUMMARY

Computer Legal Research - Westlaw	2,798.43
Other Fees	25.00
Photocopying	369.00
Local Transportation	5.00
Air Express Delivery	12.08
Facsimile	9.00
Telephone	0.24
Other Outside Services	8.70
Local Messenger Delivery	5.50
TOTAL DISBURSEMENTS	<u>\$3,232.95</u>

TOTAL FEES AND DISBURSEMENTS **\$20,467.95**

#537413

JT-APP 2780

Freeborn & Peters

June 27, 2003

FEIN #36-3238755

Mr. Leslie Bortz
R.H. Peterson
2500 W. Arthington Street
Chicago, IL 60612

COPY

Attorneys at Law

311 South Wacker Drive
Suite 3000
Chicago, Illinois 60606-6677
Tel 312.360.6000

Statement No. 99740042

Re: Patent
Client Matter ID No. 22148-0003

FOR PROFESSIONAL SERVICES RENDERED AND EXPENSES INCURRED
THROUGH MAY 31, 2003:

Chicago

Springfield

FEEES FOR THIS STATEMENT	\$86,352.50
DISBURSEMENTS	<u>5,168.94</u>
TOTAL AMOUNT OF CURRENT STATEMENT	91,521.44
BALANCE DUE	<u>\$91,521.44</u>

*PAYMENT DUE UPON RECEIPT.
INTEREST OF 1.5% PER MONTH WILL BE ADDED AFTER 30 DAYS.*

JT-APP 2781

Statement No: 99740042

For professional services rendered with regard to:

Re: Patent

May 1, 2003	DSB	Prepare appellate brief outline; office conferences with Jennifer Fitzgerald and Leland Hutchinson regarding same; review court rules regarding brief requirements.	2.90
May 1, 2003	JF	Meeting with David Becker regarding appearance, substitution of counsel, and research assignments.	1.50
May 2, 2003	DSB	Office conference with Leland Hutchinson and Jonathan Coppess regarding appellate brief; review trial transcripts; revise outline for brief; legal research regarding damages; review case file.	4.60
May 2, 2003	JWC	Meeting with David Becker and Lee Hutchinson regarding appellate brief and work to be completed.	0.50
May 4, 2003	JF	Review and outline factual arguments for appeal brief.	3.70
May 5, 2003	DSB	Legal research regarding damages issues; office conferences with Jennifer Fitzgerald and Leland Hutchinson regarding appellate brief; outline damages section; telephone conference with Jonathan Coppess regarding appendix.	6.90
May 5, 2003	LWH	Work on appeal brief.	6.40
May 5, 2003	JF	Review of outline, facts and law; meeting with David Becker regarding draft of appellate brief; meeting with Lee Hutchinson and David Becker regarding outline of brief; review of transcript and outline of arguments; office conference with Lee Hutchinson regarding claim construction, Daubert objections; outline statements of facts with citation.	10.90
May 6, 2003	DSB	Legal research regarding damages issues; office conferences with Leland Hutchinson and Jennifer Fitzgerald regarding appellate brief; review case file regarding appellate issues.	7.10
May 6, 2003	LWH	Research and draft appeal brief.	5.90
May 6, 2003	JWC	Begin work regarding Appendix for Appeal.	0.30

Freeborn & Peters

June 27, 2003

May 6, 2003	JF	Draft detailed outline of statement of facts; various office conferences with David Becker and Lee Hutchinson regarding draft of appeal brief; office conference with Jon Coppess regarding appendix.	10.80
May 7, 2003	NBK	Telephone conference with Jonathan Coppess regarding preparation of appendix for upcoming filing; prepare condense version and electronic version of 30(b)(6) deposition transcript for Jennifer Fitzgerald and David Becker	0.40
May 7, 2003	DSB	Legal research regarding damages issues; draft damages section of appellate brief; office conferences with Jennifer Fitzgerald and Leland Hutchinson regarding various appellate issues; telephone conferences with Jonathan Coppess regarding appendix preparation and legal research.	7.50
May 7, 2003	LWH	Research and draft appeal brief.	9.20
May 7, 2003	JF	Draft detailed outline of statement of facts; review various draft sections of the brief; office conferences with Lee Hutchinson and David Becker regarding facts and law and draft brief; review of designated deposition testimony.	11.70
May 8, 2003	NBK	Work on review of case documents for Defendant's Exhibits and deposition transcripts; work on investigating and obtaining deposition transcript for William McLaughlin and Leslie Bortz taken on 12/19/01 from Dean Monco of Wood Phillips law firm; telephone conference with Jennifer Fitzgerald regarding same	0.90
May 8, 2003	DSB	Draft damages section of appellate brief; revise same; legal research regarding determination of wolfullness and reliance on opinion of counsel; office and telephone conferences with Leland Hutchinson and Jennifer Fitzgerald regarding appellate brief; telephone conferences with Jonathan Coppess regarding appendix and attorney's fees issues.	8.80
May 8, 2003	LWH	Work on appeal brief.	6.20
May 8, 2003	JWC	Begin research regarding appropriateness of attorney's fees in patent cases to determine how to appeal the district court's decision to award fees.	0.50

May 8, 2003	JF	Review of designated deposition testimony; draft statement of facts; office conference with David Becker regarding damages argument and Daubert standard applicability; office conference with Nora Keough regarding appendix.	8.80
May 9, 2003	DSB	Draft and revise sections regarding damages, wilfulness and attorneys fees; telephone conferences with Jonathan Coppess regarding attorney's fees issue and appendix; telephone and office conferences with Leland Hutchinson and Jennifer Fitzgerald regarding appellate brief.	8.20
May 9, 2003	LWH	Work on appeal brief.	5.90
May 9, 2003	JWC	Continue research regarding appeal of decision to award attorney's fees.	4.90
May 9, 2003	JF	Review and revise statement of facts; review of introduction and non-infringement argument; office conferences with David Becker and Lee Hutchinson regarding drafting, arguments, statement of facts and strategy; telephone conference with Dean Monco regarding statement of facts related to customer evidence.	7.60
May 12, 2003	NBK	Meeting with Jennifer Fitzgerald and Jonathan Coppess regarding case assignment; work on review of court file for all pleadings to be included in Appendix; work on organization of same	3.00
May 12, 2003	DSB	Draft and revise appellate brief; office and telephone conference with Jennifer Fitzgerald and Leland Hutchinson regarding same; prepare appendix; office conference with Nora Keough regarding appendix; legal research regarding reasonable royalty.	9.50
May 12, 2003	LWH	Work on appeal brief.	5.50
May 12, 2003	JWC	Work on Appellate Appendix.	0.70
May 12, 2003	JF	Review of draft brief; draft modifications thereto; draft statement of facts; office conferences with Lee Hutchinson and David Becker regarding draft brief and modifications; office conference with Nora Keough and Jon Coppess regarding record on appeal.	9.90
May 13, 2003	NBK	Work on review, proofing and quality checking Appendix in preparation for filing; prepare Table of Contents regarding same	7.00

May 13, 2003	DSB	Draft and revise appellate brief; office and telephone conference with Jennifer Fitzgerald and Leland Hutchinson regarding same; prepare appendix; office conference with Nora Keough regarding appendix; legal research regarding reasonable royalty; draft section regarding reasonable royalty.	8.30
May 13, 2003	LWH	Draft appeal brief.	5.30
May 13, 2003	JF	Review and revise brief; office conferences with David Becker and Lee Hutchinson regarding the same.	6.90
May 14, 2003	DSB	Draft and revise appellate brief; office and telephone conference with Jennifer Fitzgerald and Leland Hutchinson regarding same; prepare appendix; office conference with Nora Keough regarding appendix; legal research regarding reasonable royalty.	8.40
May 14, 2003	LWH	Meet with Leslie Bortz; draft appeal brief; attention to bond issue.	7.20
May 14, 2003	JWC	Continue work on Appellate Appendix.	2.70
May 14, 2003	JF	Review and revise appeal brief; meeting with David Becker; meeting with Lee Hutchinson, David Becker and Leslie Bortz.	7.90
May 15, 2003	NBK	Work on review, proofing and quality checking Appendix in preparation for filing; revise Table of Contents regarding same	6.50
May 15, 2003	DSB	Draft and revise appellate brief; office and telephone conference with Jennifer Fitzgerald and Leland Hutchinson regarding same; prepare appendix; office conference with Nora Keough regarding appendix; legal research regarding reasonable royalty.	7.70
May 15, 2003	LWH	Work on appeal brief; meet with Leslie Bortz.	2.90
May 15, 2003	JWC	Continue work on Appellate Appendix.	7.00
May 15, 2003	JWC	Follow up work regarding court hearing.	0.20
May 15, 2003	JF	Review and revise appeal brief; meetings with Lee Hutchinson and David Becker regarding the same; office conference with David Becker and Jon Coppess regarding appendix; office conference with Leslie Bortz and Lee Hutchinson regarding brief.	6.10

Freeborn & Peters

6

June 27, 2003

May 16, 2003	NBK	Work on review, proof reading and quality checking Appendix in preparation for filing; review and revise Table of Contents to Appendix; work on service of same	9.00
May 16, 2003	JD	Edit and bluebook citations in Table of Cases and Brief; review cases cited in Brief to check citations for accuracy; edit Table of Exhibits with David Becker and Jonathan Coppess.	5.80
May 16, 2003	KDP	Revisions to confidential brief.	2.00
May 16, 2003	DSB	Add factual citations for brief; prepare and finalize appendix; draft and revise appellate brief; office and telephone conference with Jennifer Fitzgerald and Leland Hutchinson regarding same; prepare appendix; office conference with Nora Keough regarding appendix; legal research regarding reasonable royalty.	7.50
May 16, 2003	LWH	Finalize brief; conference with Leslie Bortz.	3.20
May 16, 2003	JWC	Work to complete and serve Appellate Appendix.	9.20
May 16, 2003	JF	Review and revise appellate brief and appendix; office conferences with Lee Hutchinson, David Becker and Jon Coppess regarding the same.	3.90
May 17, 2003	JF	Review and revise brief.	1.20
May 19, 2003	NBK	Work on organization of case documents and integration of same into case file system	0.30
May 19, 2003	JD	Edit citations in Table of Cases and Brief; review citations for accuracy; edit Brief; telephone conferences with David Becker regarding the same.	3.80
May 19, 2003	KDP	Assist in preparation and shipping of confidential brief.	4.00
May 19, 2003	DSB	Revise and finalize appellate brief; office conferences with Jennifer Fitzgerald, Leland Hutchinson and Jonathan Coppess regarding same.	12.30
May 19, 2003	LWH	Finalize and file appeal brief.	8.20
May 19, 2003	JWC	Follow up work on Appellate Brief.	3.50
May 19, 2003	JF	Review and revise brief; preparation of brief for filing.	10.90
May 20, 2003	LWH	Conference regarding brief and appeal.	0.60
May 28, 2003	JF	Telephone conference with Lee Hutchinson and William Gaines regarding confidential information, notice to the court and protection thereof.	0.30

JT-APP 2786

Freeborn & Peters

7

June 27, 2003

FEE SUMMARY

<u>TIMEKEEPER</u>	<u>HOURS</u>	<u>RATE</u>	<u>FEES</u>
Fitzgerald, Jennifer L.	102.10	295.00	\$30,119.50
Becker, David S.	99.70	195.00	\$19,441.50
Coppess, Jonathan W.	29.50	185.00	\$5,457.50
Clark (Dohm), Janel	9.60	175.00	\$1,680.00
Keough, Nora B	27.10	115.00	\$3,116.50
Paige, Kellie D.	6.00	45.00	\$270.00
Hutchinson, Leland W.	66.50	395.00	\$26,267.50
TOTAL HOURS	340.50		
TOTAL FEES			<u>\$86,352.50</u>

DISBURSEMENTS

Apr 6, 2003	JWC	Parking (311 South Wacker) 04/06 Parking charge re: working weekend	10.00
Apr 30, 2003	JWC	Local Transportation VENDOR: Flash Cab Co; INVOICE#: 2000034810; DATE: 4/30/03 03/21 - 04/30 Cab fare charges	14.00
May 5, 2003	DSB	Telephone 202 3125527	0.06
May 5, 2003	DSB	Air Express Delivery Clerk of the Court 16553	17.56
May 6, 2003	DSB	Computer Legal Research - Westlaw 05/03 Westlaw Charges	369.43
May 8, 2003	DSB	Computer Legal Research - Westlaw 05/03 Westlaw Charges	54.96
May 8, 2003	NBK	Local Messenger Delivery Wood Phillips 5987-520	10.00
May 9, 2003	JWC	Computer Legal Research - Westlaw 05/03 Westlaw Charges	624.35
May 9, 2003	DSB	Computer Legal Research - Westlaw 05/03 Westlaw Charges	369.25
May 12, 2003	DVS	Facsimile 312 6665810	3.00
May 12, 2003	DSB	Telephone 202 3125527	0.12
May 13, 2003	DSB	Telephone 202 3125527	0.72

JT-APP 2787

Freeborn & Peters

8

June 27, 2003

May 13, 2003	DSB	Computer Legal Research - Westlaw 05/03 Westlaw Charges	91.06
May 14, 2003	DSB	Computer Legal Research - Westlaw 05/03 Westlaw Charges	112.59
May 15, 2003	DSB	Telephone 202 3125527	0.18
May 15, 2003	JWC	Telephone 202 3125527	0.18
May 15, 2003	FIRM	Telephone 972 - - - -	0.24
May 16, 2003	JWC	Telephone 202 3125527	0.06
May 16, 2003	FIRM	Telephone 972 4808800	0.24
May 16, 2003	NBK	Outside Photocopying VENDOR: 24 Seven Copies, Inc.; INVOICE#: 10862; DATE: 5/16/03 Outside photocopying/Bates labeling	2,099.70
May 16, 2003	FIRM	Telephone 972 4808800	0.12
May 16, 2003	JWC	Telephone 202 3125527	0.30
May 16, 2003	JF	Air Express Delivery William Harris Charles 97542	72.62
May 19, 2003	LWH	Air Express Delivery Clerk of the Court 97542	53.07
May 19, 2003	LWH	Air Express Delivery Mr. William Harris 97542	27.73
May 19, 2003	JWC	Computer Legal Research - Westlaw 08/03 Westlaw Charges	8.79
May 19, 2003	JWC	Telephone 202 3125528	0.06
May 19, 2003	DSB	Computer Legal Research - Westlaw 05/03 Westlaw Charges	131.43
May 19, 2003	FIRM	Photocopying	171.20
May 28, 2003	JF	Telephone 972 6699906	0.72
May 29, 2003	FIRM	Photocopying	925.20

JT-APP 2788

Freeborn & Peters

9

June 27, 2003

DISBURSEMENT SUMMARY

Local Messenger Delivery	10.00
Facsimile	3.00
Photocopying	1,096.40
Computer Legal Research - Westlaw	1,761.86
Air Express Delivery	170.98
Telephone	3.00
Local Transportation	14.00
Outside Photocopying	2,099.70
Parking (311 South Wacker)	10.00
TOTAL DISBURSEMENTS	<u>\$5,168.94</u>

TOTAL FEES AND DISBURSEMENTS	\$91,521.44
------------------------------	-------------

#545407

JT-APP 2789

Freeborn & Peters LLP

August 15, 2003

FEIN #36-3238755

COPY

Mr. Leslie Bortz
R.H. Peterson
2500 W. Arthington Street
Chicago, IL 60612

Attorneys at Law

Statement No. 99748116

311 South Wacker Drive
Suite 3000
Chicago, Illinois 60606-6677
Tel 312.360.6000

Re: Patent
Client Matter ID No. 22148-0003

FOR PROFESSIONAL SERVICES RENDERED AND EXPENSES INCURRED
THROUGH JULY 31, 2003:

Chicago

FEES FOR THIS STATEMENT \$41,674.00

Springfield

DISBURSEMENTS 16,686.52

TOTAL AMOUNT OF CURRENT STATEMENT 58,360.52

BALANCE DUE \$58,360.52

**PAYMENT DUE UPON RECEIPT.
INTEREST OF 1.5% PER MONTH WILL BE ADDED AFTER 30 DAYS.**

JT-APP 2790

Statement No: 99748116

For professional services rendered with regard to:

Re: Patent

Jun 30, 2003	DSB	Office conference with Jennifer Fitzgerald regarding appellate reply, case status and strategy.	0.40
Jun 30, 2003	LWH	Telephone conference with opposing counsel regarding brief.	0.60
Jun 30, 2003	JF	Review of local rules regarding brief and oral argument and scheduling; office conferences with Leland Hutchinson and David Becker regarding the same.	0.40
Jul 2, 2003	NBK	Prepare and organize exhibits CITCO in Brief of Plaintiff-Appellee Golden Blount for Jennifer Fitzgerald review	4.90
Jul 2, 2003	DSB	Review appellee's brief and legal research regarding same; office conference with Leland Hutchinson and Jennifer Fitzgerald regarding same.	5.80
Jul 2, 2003	JF	Review of Blount response brief; strategy meeting with Leland Hutchinson and David Becker regarding reply brief; coordinate document review with Nora Keough and Jonathan Coppess.	5.70
Jul 3, 2003	DSB	Review response brief; legal research regarding reply; outline reply brief.	2.60
Jul 3, 2003	JF	Review of response brief; legal research regarding the same; office conference with David Becker regarding strategy and drafting of reply.	1.90
Jul 6, 2003	DSB	Outline and begin drafting appellate reply brief; legal research regarding same.	2.70
Jul 7, 2003	DSB	Draft and revise appellate reply brief; office conferences with Jennifer Fitzgerald regarding same.	9.40
Jul 7, 2003	JWC	Work regarding reply brief in patent appeal, including locating documents needed for brief and research of patent issues.	4.00
Jul 7, 2003	JF	Draft reply brief; office conferences with Leland Hutchinson, David Becker and Jonathan Coppess regarding reply brief; legal research regarding the same.	9.90

Jul 8, 2003	NBK	Telephone conference with Jennifer Fitzgerald regarding case assignments; prepare fax and court documents to be sent to Leslie Bortz; coordinate and prepare appendix to Joint Appendix to be sent to Leslie Bortz	1.10
Jul 8, 2003	DSB	Draft and revise appellate reply brief; office conferences with Jennifer Fitzgerald regarding same.	10.30
Jul 8, 2003	JWC	Research regarding staple of commerce definition for patent appeal reply brief.	3.90
Jul 8, 2003	JF	Draft reply brief; telephone conference with Leslie Bortz; office conference with David Becker regarding draft reply brief; legal research regarding the same; telephone conference with Leland Hutchinson regarding draft brief; office conference with Jonathan Coppess regarding legal research issues.	9.70
Jul 9, 2003	NBK	Review three volume Appendix for all documents designated as Confidential Attorney eyes only and prepare list regarding same for Jennifer Fitzgerald review	3.50
Jul 9, 2003	DSB	Draft appellate brief; office conference with Jennifer Fitzgerald regarding same; legal research regarding same.	8.60
Jul 9, 2003	JF	Review and revise reply brief; draft reply brief; office conferences with David Becker regarding the same; telephone conferences with Hitt Gaines regarding settlement and agreed extension to file reply; review settlement options; review of correspondence from federal circuit court regarding non-acceptance of Blount brief; telephone conference with Leslie Bortz; draft motion to extend time based on refusal of response brief by court; telephone conference with Leland Hutchinson regarding brief status and settlement strategy.	7.90
Jul 10, 2003	DSB	Draft appellate brief; office conference with Jennifer Fitzgerald regarding same; legal research regarding same.	5.50
Jul 10, 2003	JWC	Follow up work regarding appellate reply brief and research.	0.40

Jul 10, 2003	JF	Review and revise appellate brief; telephone conference with Leland Hutchinson regarding the same; office conferences with Jonathan Coppess and David Becker regarding draft brief, additional sections and legal research; telephone conferences with Leslie Bortz; settlement conference with Hitt Gaines.	9.70
Jul 11, 2003	DSB	Draft appellate brief; office conference with Jennifer Fitzgerald regarding same; legal research regarding same	3.90
Jul 11, 2003	LWH	Edit appeal reply brief; conferences regarding same.	6.80
Jul 11, 2003	JWC	Follow up research regarding patent appeal issues.	1.00
Jul 11, 2003	JF	Review of legal research for reply brief; office conferences with Leland Hutchinson and David Becker regarding draft; review and revise brief.	9.20
Jul 12, 2003	DSB	Telephone conference with Leland Hutchinson regarding appellate brief.	0.30
Jul 12, 2003	LWH	Edit appeal reply brief.	2.60
Jul 13, 2003	JF	Review and revise appellate reply brief; office conference with Leland Hutchinson regarding draft brief and modifications; legal research regarding the same.	4.40
Jul 14, 2003	DSB	Finalize and edit appellate reply; oversee filing of same.	4.10
Jul 14, 2003	JF	Prepare reply brief for filing; review and revise the same; telephone conference with Leslie Bortz regarding draft brief; office conferences with David Becker regarding revisions to brief.	7.10
Jul 16, 2003	JWC	Work regarding completion and filing of Joint Appendix in patent appeal.	2.00
Jul 17, 2003	JW	Work on designation of certain portions of documents contained in the Joint Appendix as confidential.	2.50
Jul 17, 2003	NBK	Meeting with Jonathan Coppess regarding designation of Confidential portions of the Joint Appendix; work on quality checking master sets of Joint Appendix for accuracy and completeness; work on designations of certain portions of Joint Appendix as Confidential.	8.00
Jul 17, 2003	MK	Work on designating certain portions of documents contained in the Joint Appendix as Confidential.	2.50
Jul 17, 2003	JWC	Continue work to finalize and file Joint Appendix in patent appeal.	3.90

Freeborn & Peters LLP

August 15, 2003

Jul 17, 2003	JF	Prepare draft statement of compliance that settlement conference has been held; office conferences with Jonathan Coppess regarding filing of joint appendix and statement of compliance.	1.20
Jul 18, 2003	NBK	Organize, prepare and quality check multiple copies of the Confidential and Non-Confidential versions of Joint Appendix for filing with the court; meeting with Jonathan Coppess regarding same; prepare Rule 33 Statement of Compliance for filing	5.10
Jul 18, 2003	JWC	Work to finalize and file the Joint Appendix in patent appeal.	2.50
Jul 18, 2003	JF	Preparation of appendix and statement of compliance for filing; office conferences with Jonathan Coppess regarding the same.	0.90
Jul 21, 2003	NBK	Work on organization of case file documents and integration of documents into case file system; update case file index; telephone conference with Jonathan Coppess regarding status of filing	2.20
Jul 22, 2003	NBK	Work on tracking boxes sent Federal Express to the U.S. Court of Appeals; telephone conference with Jonathan Coppess and court clerk regarding receipt and processing of Joint Appendix; work on integration of Joint Appendix into case file system; update Case File Index	1.50
Jul 22, 2003	JWC	Follow up work regarding Joint Appendix filing.	0.20
Jul 23, 2003	NBK	Meeting with Jonathan Coppess regarding status of filing of Appendix with U.S. Court of Appeals; telephone conference with Christy Davis regarding same; prepare Non-Confidential Joint Appendix cover pages for Jonathan Coppess; prepare service of same	0.70
Jul 23, 2003	JWC	Follow up work regarding Joint Appendix, including draft letter to Clerk of Court.	0.30
Jul 28, 2003	JWC	Follow up work regarding Joint Appendix.	1.50

FEE SUMMARY

<u>TIMEKEEPER</u>	<u>HOURS</u>	<u>RATE</u>	<u>FEES</u>
Fitzgerald, Jennifer L.	68.00	295.00	\$20,060.00
Becker, David S.	53.60	195.00	\$10,452.00
Coppess, Jonathan W.	19.70	185.00	\$3,644.50
Keough, Nora B	27.00	115.00	\$3,105.00
Whittington, Jennifer	2.50	115.00	\$287.50

Freeborn & Peters LLP

6

August 15, 2003

<u>TIMEKEEPER</u>	<u>HOURS</u>	<u>RATE</u>	<u>FEES</u>
Kirkpatrick, Matthew	2.50	70.00	\$175.00
Hutchinson, Leland W.	10.00	395.00	\$3,950.00
TOTAL HOURS	183.30		
TOTAL FEES			<u>\$41,674.00</u>

DISBURSEMENTS

May 15, 2003	NBK	Local Transportation VENDOR: Flash Cab Co; INVOICE#: 2000035503; DATE: 5/15/03 04/29 - 05/15 Cab fare charges	17.82
May 31, 2003	JWC	Local Transportation VENDOR: Flash Cab Co; INVOICE#: 2000036061; DATE: 5/31/03 05/08 - 05/31 Cab fare charges	16.00
May 31, 2003	JY	Local Transportation VENDOR: Flash Cab Co; INVOICE#: 2000036061; DATE: 5/31/03 05/08 - 05/31 Cab fare charges	20.00
May 31, 2003	KDP	Local Transportation VENDOR: Flash Cab Co; INVOICE#: 2000036061; DATE: 5/31/03 05/08 - 05/31 Cab fare charges	85.00
May 31, 2003	KDP	Local Transportation VENDOR: Flash Cab Co; INVOICE#: 2000036061; DATE: 5/31/03 05/08 - 05/31 Cab fare charges	95.00
Jun 2, 2003	BM	Other Outside Services VENDOR: LexisNexis CourtLink, Inc.; INVOICE#: EA106341; DATE: 6/2/03 05/03 CourtLink online docket charges	8.70
Jun 15, 2003	NBK	Local Transportation VENDOR: Flash Cab Co; INVOICE#: 2000037113; DATE: 6/15/03 05/16 Cab fare charge	18.00
Jun 30, 2003	JWC	Meal and Conference Expense VENDOR: Coppess, Jonathan; INVOICE#: 063030G; DATE: 6/30/03 05/14 Dinner expense for working late	10.81

Freeborn & Peters LLP

7

August 15, 2003

Jul 2, 2003	NBK	Color copies 1 color copy	0.50
Jul 2, 2003	NBK	Color copies 3 color copies	1.50
Jul 2, 2003	FIRM	Air Express Delivery Mr. Lestic Boitz 34832	12.39
Jul 7, 2003	DM	Meal and Conference Expense VENDOR: CEO Deliveries, Inc.; INVOICE#: 106218; DATE: 7/7/03 07/07 Dinner expense re: working late (D. Becker & J. Fitzferald)	23.68
Jul 7, 2003	JF	Computer Legal Research - Westlaw 07/03 Westlaw Charges	167.20
Jul 7, 2003	DSB	Computer Legal Research - Westlaw 07/03 Westlaw Charges	633.35
Jul 7, 2003	JWC	Computer Legal Research - Westlaw 07/03 Westlaw Charges	969.03
Jul 7, 2003	JF	Computer Legal Research - Westlaw 07/03 Westlaw Charges	89.80
Jul 8, 2003	DSB	Computer Legal Research - Westlaw 07/03 Westlaw Charges	194.22
Jul 8, 2003	NBK	Facsimile 312 6665810	5.00
Jul 8, 2003	JF	Computer Legal Research - Westlaw 07/03 Westlaw Charges	76.36
Jul 8, 2003	NBK	Local Messenger Delivery R. H Peterson 6106-042	20.75
Jul 8, 2003	JWC	Computer Legal Research - Westlaw 07/03 Westlaw Charges	644.88
Jul 9, 2003	DSB	Computer Legal Research - Westlaw 07/03 Westlaw Charges	131.26
Jul 9, 2003	DSB	Telephone 202 3125534	0.18
Jul 9, 2003	DSB	Telephone 202 3125534	0.06
Jul 9, 2003	JY	Facsimile 972 4808865	8.00
Jul 9, 2003	JY	Facsimile 202 6339623	9.00
Jul 9, 2003	DSB	Telephone 972 4808800	0.66
Jul 9, 2003	JF	Computer Legal Research - Westlaw 07/03 Westlaw Charges	108.23

JT-APP 2796

Freeborn & Peters LLP

8

August 15, 2003

Jul 10, 2003	DSB	Facsimile 972 4808865	2.00
Jul 10, 2003	JF	Computer Legal Research - Westlaw 07/03 Westlaw Charges	69.16
Jul 10, 2003	JF	Telephone 972 4808800	0.12
Jul 11, 2003	DSB	Computer Legal Research - Westlaw 07/03 Westlaw Charges	281.30
Jul 11, 2003	JWC	Computer Legal Research - Westlaw 07/03 Westlaw Charges	195.82
Jul 13, 2003	JF	Computer Legal Research - Westlaw 07/03 Westlaw Charges	162.37
Jul 14, 2003	JF	Computer Legal Research - Westlaw 07/03 Westlaw Charges	187.84
Jul 14, 2003	JF	Computer Legal Research - Westlaw 07/03 Westlaw Charge	192.41
Jul 14, 2003	DSB	Computer Legal Research - Westlaw 07/03 Westlaw Charges	224.34
Jul 14, 2003	FIRM	Photocopying	1,619.60
Jul 16, 2003	JWC	Telephone 972 4808800	0.12
Jul 16, 2003	JF	Computer Legal Research - Westlaw 07/03 Westlaw Charges	18.83
Jul 17, 2003	JWC	Telephone 202 3125527	0.18
Jul 17, 2003	JWC	Telephone 972 4808800	0.12
Jul 17, 2003	JWC	Telephone 972 4808800	0.12
Jul 18, 2003	NBK	Outside Photocopying VENDOR: 24 Seven Copies, Inc.; INVOICE#: 12335; DATE: 7/18/03 Outside photocopying	10,331.25
Jul 18, 2003	JWC	Telephone 972 4808800	0.12
Jul 18, 2003	JWC	Telephone 202 3125527	0.12
Jul 21, 2003	JWC	Telephone 202 3125527	0.06
Jul 22, 2003	NBK	Telephone 202 6336550	0.12

JT-APP 2797

Freeborn & Peters LLP

9

August 15, 2003

Jul 22, 2003	NBK	Telephone 202 6336550	0.30
Jul 23, 2003	NBK	Telephone 202 6336550	0.12
Jul 23, 2003	FIRM	Photocopying	27.00
Jul 28, 2003	JWC	Facsimile 202 7833405	5.00
Jul 28, 2003	JWC	Telephone 202 3125536	0.24
Jul 28, 2003	JWC	Telephone 202 7837288	0.48

DISBURSEMENT SUMMARY

Local Messenger Delivery	20.75
Telephone	3.12
Facsimile	29.00
Other Outside Services	8.70
Local Transportation	251.82
Meal and Conference Expense	34.49
Air Express Delivery	12.39
Color copies	2.00
Computer Legal Research - Westlaw	4,346.40
Outside Photocopying	10,331.25
Photocopying	1,646.60
TOTAL DISBURSEMENTS	<u>\$16,686.52</u>

TOTAL FEES AND DISBURSEMENTS	\$58,360.52
-------------------------------------	--------------------

#557254

JT-APP 2798

Freeborn & Peters LLP

September 19, 2003

FEIN #36-3238755

COPY

Mr. Leslie Bortz
R.H. Peterson
2500 W. Arthington Street
Chicago, IL 60612

Attorneys at Law

South Wacker Drive
Suite 3000
Chicago, Illinois 60606-6677
312.360.6000

Statement No. 99752181

Re: Patent
Client Matter ID No. 22148-0003

FOR PROFESSIONAL SERVICES RENDERED AND EXPENSES INCURRED
THROUGH AUGUST 31, 2003:

Chicago

Springfield

FEES FOR THIS STATEMENT	\$1,043.00
DISBURSEMENTS	<u>839.11</u>
TOTAL AMOUNT OF CURRENT STATEMENT	1,882.11
BALANCE DUE	<u>\$1,882.11</u>

PAYMENT DUE UPON RECEIPT.
INTEREST OF 1.5% PER MONTH WILL BE ADDED AFTER 30 DAYS.

JT-APP 2799

Freeborn & Peters LLP

2

September 19, 2003

Statement No: 99752181

For professional services rendered with regard to:

Re: Patent

Aug 1, 2003	AG	Telephone conference with John Stiefel regarding facts of case; analyze 735 I.L.C.S. 5/13-214.3 and corresponding case law that discusses statute of limitations for claims of attorney malpractice.	0.90
Aug 4, 2003	LWH	Telephone conference regarding limitations issues.	0.40
Aug 4, 2003	AG	Analyze Illinois statute and corresponding cases that discuss statute of limitations for claims of attorney malpractice; draft bullet-point memorandum describing Illinois statutes of limitations and repose for attorney malpractice.	4.70
Aug 5, 2003	AG	Finalize bullet-point memorandum describing Illinois statutes of limitations and repose for attorney malpractice; telephone conference with John Stiefel regarding research findings.	0.30

FEE SUMMARY

<u>TIMEKEEPER</u>	<u>HOURS</u>	<u>RATE</u>	<u>FEES</u>
Gandhi, Ami D.	5.90	150.00	\$885.00
Hutchinson, Leland W.	0.40	395.00	\$158.00
TOTAL HOURS	6.30		
TOTAL FEES			<u>\$1,043.00</u>

DISBURSEMENTS

Jul 14, 2003	DSB	Air Express Delivery William Harris 18626	18.59
Jul 14, 2003	DSB	Air Express Delivery United State Court of Appeals 18626	23.29
Jul 18, 2003	NBK	Air Express Delivery C. Gaines 18626	60.47
Jul 18, 2003	NBK	Air Express Delivery Charles Gaines 18626	60.47

JT-APP 2800

Freeborn & Peters LLP

3

September 19, 2003

Jul 18, 2003	NBK	Air Express Delivery Clerk of Court 18626	38.36
Jul 18, 2003	NBK	Air Express Delivery Clerk of Court 18626	56.36
Jul 18, 2003	NBK	Air Express Delivery Clerk of Court 18626	56.36
Jul 18, 2003	NBK	Air Express Delivery Clerk of Court 18626	56.36
Jul 18, 2003	NBK	Air Express Delivery Clerk of the Court 18626	56.36
Jul 18, 2003	NBK	Air Express Delivery Clerk of Court 18626	56.36
Jul 18, 2003	NBK	Air Express Delivery Clerk of Court 18626	56.36
Jul 18, 2003	NBK	Air Express Delivery Clerk of Court 18626	56.36
Jul 18, 2003	NBK	Air Express Delivery Clerk of Court 18626	56.36
Jul 18, 2003	NBK	Air Express Delivery Clerk of Court 18626	17.22
Jul 21, 2003	NBK	Air Express Delivery Jennifer Fitzgerald 57020	53.64
Jul 23, 2003	JWC	Air Express Delivery C. Davis 57020	11.79
Jul 31, 2003	JWC	Other Outside Services VENDOR: Counsel Press LLC; INVOICE#: 3076552; DATE: 7/31/03 07/31 Paralegal court time	101.20
Aug 11, 2003	FIRM	Photocopying	3.20

DISBURSEMENT SUMMARY

Other Outside Services	101.20
Photocopying	3.20
Air Express Delivery	734.71
TOTAL DISBURSEMENTS	<u>\$839.11</u>

TOTAL FEES AND DISBURSEMENTS	\$1,882.11
------------------------------	-------------------

#564587

JT-APP 2801

Freeborn & Peters LLP

October 22, 2003

FEIN #36-3238755

COPY

Mr. Leslie Bortz
R.H. Peterson
2500 W. Arthington Street
Chicago, IL 60612

Attorneys at Law

Statement No. 99756012

South Wacker Drive
3000
Chicago, Illinois 60606-6677
312.360 6000

Re: Patent
Client Matter ID No. 22148-0003

FOR PROFESSIONAL SERVICES RENDERED AND EXPENSES INCURRED
THROUGH SEPTEMBER 30, 2003:

Chicago

Springfield

FEES FOR THIS STATEMENT	\$1,975.00
DISBURSEMENTS	<u>53.80</u>
TOTAL AMOUNT OF CURRENT STATEMENT	2,028.80
BALANCE DUE	<u>\$2,028.80</u>

PAYMENT DUE UPON RECEIPT.
INTEREST OF 1.5% PER MONTH WILL BE ADDED AFTER 30 DAYS.

JT-APP 2802

Freeborn & Peters LLP

2

October 22, 2003

Statement No: 99756012

For professional services rendered with regard to:

Re: Patent

Sep 5, 2003	LWH	Draft Tolling Agreement.	1.20
Sep 8, 2003	LWH	Finalize tolling agreement and draft letter.	1.80
Sep 9, 2003	LWH	Finalize demand letter and tolling agreement; send same.	0.70
Sep 16, 2003	LWH	Attention to Tolling Agreement; email regarding same.	0.50
Sep 30, 2003	LWH	Attention to appeal issues and timing; telephone conference.	0.80

FEE SUMMARY

<u>TIMEKEEPER</u>	<u>HOURS</u>	<u>RATE</u>	<u>FEEES</u>
Hutchinson, Leland W.	5.00	395.00	\$1,975.00
TOTAL HOURS	5.00		
TOTAL FEES			<u>\$1,975.00</u>

DISBURSEMENTS

Sep 9, 2003	LFG	Local Messenger Delivery Wood Phillips Katz Clark 6236-736	5.50
Sep 15, 2003	LFG	Local Messenger Delivery Wood Phillips 6249-332	5.50
Sep 18, 2003	DVS	Facsimile 312 6665810	7.00
Sep 29, 2003	FIRM	Photocopying	35.80

DISBURSEMENT SUMMARY

Local Messenger Delivery	11.00
Facsimile	7.00
Photocopying	35.80
TOTAL DISBURSEMENTS	<u>\$53.80</u>

TOTAL FEES AND DISBURSEMENTS **\$2,028.80**

#571165

Freeborn & Peters LLP

November 21, 2003

FEIN #36-3238755

Mr. Leslie Bortz
R.H. Peterson
2500 W. Arthington Street
Chicago, IL 60612

COPY

Attorneys at Law

311 South Wacker Drive
Suite 3000
Chicago, Illinois
60606-6677
Tel 312-360-6000
Fax 312-360-6520

Statement No. 99757806

Re: Patent
Client Matter ID No. 22148-0003

FOR PROFESSIONAL SERVICES RENDERED AND EXPENSES INCURRED
THROUGH OCTOBER 31, 2003:

PREVIOUS BALANCE	\$103,356.71
FEEs FOR THIS STATEMENT	\$8,833.50
DISBURSEMENTS	<u>\$580.23</u>
TOTAL AMOUNT OF CURRENT STATEMENT	\$9,413.73

Chicago
Springfield

OUTSTANDING STATEMENT RECAP

<u>BILL DATE</u>	<u>BILL #</u>	<u>FEES</u>	<u>COSTS</u>	<u>PAID</u>	<u>BALANCE UNPAID</u>
June 27, 2003	99740042	86,352.50	5,168.94	48,554.05	42,967.39
August 15, 2003	99748116	41,674.00	16,686.52	0.00	58,360.52
October 22, 2003	99756012	1,975.00	53.80	0.00	2,028.80
TOTAL OUTSTANDING A/R					\$103,356.71
TOTAL OUTSTANDING AND CURRENT AMOUNTS					\$112,770.44

PAYMENT DUE UPON RECEIPT.
INTEREST OF 1.5% PER MONTH WILL BE ADDED AFTER 30 DAYS.

JT-APP 2804

Freeborn & Peters LLP

2

November 21, 2003

Statement No: 99757806

For professional services rendered with regard to:

Re: Patent

Oct 3, 2003	LWH	Attention to oral argument; review file.	1.90
Oct 7, 2003	NBK	Review case file files for Appellate briefing; prepare same for Lee Hutchinson review	0.50
Oct 8, 2003	LWH	Prepare for oral argument on appeal; review briefs.	2.80
Oct 9, 2003	NBK	Work on review of case file materials; update Appellate Court file; update Pleadings Index	1.50
Oct 10, 2003	LWH	Attention to appeal filings.	0.80
Oct 16, 2003	LWH	Conference regarding oral argument.	0.60
Oct 17, 2003	LWH	Prepare for oral argument; review briefs.	1.90
Oct 28, 2003	LWH	Conference with client; prepare for oral argument.	1.90
Oct 28, 2003	JF	Office conference with Lee Hutchinson regarding oral argument; review of briefs and statement of facts.	1.80
Oct 29, 2003	LWH	Meeting to prepare for oral argument.	2.80
Oct 29, 2003	JF	Review of briefs and preparation for strategy meeting with Lee Hutchinson; legal research regarding patent issues.	5.40
Oct 30, 2003	PMN	Obtain copies of cases for Jennifer Fitzgerald.	0.40
Oct 30, 2003	JF	Preparation for argument before the Federal Circuit.	0.60
Oct 31, 2003	LWH	Meet with Leslie Bortz; prepare for oral argument.	3.20

FEE SUMMARY

<u>TIMEKEEPER</u>	<u>HOURS</u>	<u>RATE</u>	<u>FEES</u>
Fitzgerald, Jennifer L.	7.80	295.00	\$2,301.00
Keough, Nora B	2.00	115.00	\$230.00
Newman, P. Maureen	0.40	55.00	\$22.00
Hutchinson, Leland W.	15.90	395.00	\$6,280.50
TOTAL HOURS	26.10		
TOTAL FEES			<u>\$8,833.50</u>

*PAYMENT DUE UPON RECEIPT.
INTEREST OF 1.5% PER MONTH WILL BE ADDED AFTER 30 DAYS.*

JT-APP 2805

Freeborn & Peters LLP

3

November 21, 2003

DISBURSEMENTS

Oct 7, 2003	FIRM	Photocopying	144.20
Oct 10, 2003	LFG	Telephone 202 3125523	0.06
Oct 22, 2003	FIRM	Photocopying	57.00
Oct 29, 2003	JF	Computer Legal Research - Westlaw 10/03 Westlaw Charges	199.86
Oct 30, 2003	PMN	Computer Legal Research - Westlaw 10/03 Westlaw Charges	98.43
Nov 3, 2003	JF	Computer Legal Research - Westlaw 11/03 Westlaw Charges	80.68

DISBURSEMENT SUMMARY

Telephone	0.06
Photocopying	201.20
Computer Legal Research - Westlaw	378.97
TOTAL DISBURSEMENTS	<u>\$580.23</u>
TOTAL FEES AND DISBURSEMENTS	\$9,413.73

#577465

*PAYMENT DUE UPON RECEIPT.
INTEREST OF 1.5% PER MONTH WILL BE ADDED AFTER 30 DAYS.*

JT-APP 2806

Freeborn & Peters LLP

December 17, 2003

FEIN #36-3238755

COPY

Mr. Leslie Bortz
R.H. Peterson
2500 W. Arthington Street
Chicago, IL 60612

Attorneys at Law

11 South Wacker Drive
Suite 3000
Chicago, Illinois
0606-6677
el 312-360-6000
fx 312-360-6520

Statement No. 99762507

Re: Patent
Client Matter ID No. 22148-0003

FOR PROFESSIONAL SERVICES RENDERED AND EXPENSES INCURRED
THROUGH NOVEMBER 30, 2003:

PREVIOUS BALANCE	\$112,770.44
FEES FOR THIS STATEMENT	\$10,614.50
DISBURSEMENTS	<u>\$963.34</u>
TOTAL AMOUNT OF CURRENT STATEMENT	\$11,577.84

*Chicago
Springfield*

OUTSTANDING STATEMENT RECAP

<u>BILL DATE</u>	<u>BILL #</u>	<u>FEES</u>	<u>COSTS</u>	<u>PAID</u>	<u>BALANCE UNPAID</u>
June 27, 2003	99740042	86,352.50	5,168.94	48,554.05	42,967.39
August 15, 2003	99748116	41,674.00	16,686.52	0.00	58,360.52
October 22, 2003	99756012	1,975.00	53.80	0.00	2,028.80
November 21, 2003	99757806	8,833.50	580.23	0.00	9,413.73
TOTAL OUTSTANDING A/R					\$112,770.44
TOTAL OUTSTANDING AND CURRENT AMOUNTS					\$124,348.28

*PAYMENT DUE UPON RECEIPT.
INTEREST OF 1.5% PER MONTH WILL BE ADDED AFTER 30 DAYS.*

Freeborn & Peters LLP

2

December 17, 2003

Statement No: 99762507

For professional services rendered with regard to:

Re: Patent

Nov 1, 2003	LWH	Prepare for Oral Argument.	1.60
Nov 2, 2003	LWH	Prepare for Oral Argument.	3.40
Nov 3, 2003	LWH	Travel to Washington DC for Oral Argument; prepare for same.	5.40
Nov 3, 2003	JF	Travel to Washington DC; preparation for oral argument; review of briefs and legal research; meeting with Lee Hutchinson regarding the same.	7.00
Nov 4, 2003	LWH	Attend Oral Argument; return to Chicago.	5.90
Nov 4, 2003	JF	Preparation for oral argument; review of briefs and legal research; meeting with Lee Hutchinson regarding same travel from Washington.	7.00
Nov 25, 2003	NBK	Review case file and prepare December 10, 1999 patent infringement letter for Lee Hutchinson review	0.40

FEE SUMMARY

<u>TIMEKEEPER</u>	<u>HOURS</u>	<u>RATE</u>	<u>FEES</u>
Fitzgerald, Jennifer L.	14.00	295.00	\$4,130.00
Keough, Nora B	0.40	115.00	\$46.00
Hutchinson, Leland W.	16.30	395.00	\$6,438.50
TOTAL HOURS	30.70		
TOTAL FEES			<u>\$10,614.50</u>

DISBURSEMENTS

Nov 10, 2003	JF	Travel Expense VENDOR: Fitzgerald, Jennifer; INVOICE#: 111003; DATE: 11/10/03 11/03 Travel expenses to/from Washington, DC, for oral argument	267.86
Nov 11, 2003	LWH	Travel Expense VENDOR: Hutchinson, Leland W.; INVOICE#: 111103; DATE: 11/11/03 11/03-04 Travel expenses to/from Washington, DC, for oral argument hearing	684.68

*PAYMENT DUE UPON RECEIPT.
INTEREST OF 1.5% PER MONTH WILL BE ADDED AFTER 30 DAYS.*

JT-APP 2808

Freeborn & Peters LLP

Dec 3, 2003 FIRM Photocopying 3 December 17, 2003 10.80

DISBURSEMENT SUMMARY

Travel Expense	952.54
Photocopying	10.80
TOTAL DISBURSEMENTS	<u>\$963.34</u>
TOTAL FEES AND DISBURSEMENTS	\$11,577.84

#583065

*PAYMENT DUE UPON RECEIPT.
INTEREST OF 1.5% PER MONTH WILL BE ADDED AFTER 30 DAYS.*

JT-APP 2809

Freeborn & Peters LLP

January 26, 2004

FEIN #36-3238755

COPY

Mr. Leslie Bortz
R.H. Peterson
2500 W. Arthington Street
Chicago, IL 60612

Attorneys at Law

Statement No. 99766525

South Wacker Drive
c 3000
Chicago, Illinois 60606-6677
312.360.6000

Re: Patent
Client Matter ID No. 22148-0003

FOR PROFESSIONAL SERVICES RENDERED AND EXPENSES INCURRED
THROUGH DECEMBER 31, 2003:

Chicago

Springfield

FEEs FOR THIS STATEMENT	\$23.00
DISBURSEMENTS	<u>896.64</u>
TOTAL AMOUNT OF CURRENT STATEMENT	919.64
BALANCE DUE	<u>\$919.64</u>

PAYMENT DUE UPON RECEIPT.
INTEREST OF 1.5% PER MONTH WILL BE ADDED AFTER 30 DAYS.

JT-APP 2810

Freeborn & Peters LLP

2

January 26, 2004

Statement No: 99766525

For professional services rendered with regard to:

Re: Patent

Dec 1, 2003	NBK	Update correspondence and pleadings file; update Pleadings Index	0.20
-------------	-----	--	------

FEE SUMMARY

<u>TIMEKEEPER</u>	<u>HOURS</u>	<u>RATE</u>	<u>FEES</u>
Keough, Nora B	0.20	115.00	\$23.00
TOTAL HOURS	0.20		
TOTAL FEES			<u>\$23.00</u>

DISBURSEMENTS

Nov 19, 2003	JF	Travel Expense VENDOR: Diners Club; INVOICE#: STMT11/19/03; DATE: 11/19/03 11/13 Travel to Washington re: client matters	563.00
Dec 18, 2003	FIRM	Photocopying	1.40
Dec 19, 2003	LWH	Travel Expense VENDOR: Hutchinson, Leland W.; INVOICE#: 121903; DATE: 12/19/03 11/03-04 Travel expenses to/from Washington, D.C. to prepar for oral argument	332.24

DISBURSEMENT SUMMARY

Photocopying	1.40
Travel Expense	895.24
TOTAL DISBURSEMENTS	<u>\$896.64</u>
TOTAL FEES AND DISBURSEMENTS	<u>\$919.64</u>

#589823

JT-APP 2811

Freeborn & Peters LLP

March 31, 2004

FEIN #36-3238755

Mr. Leslie Bortz
R.H. Peterson
2500 W. Arthington Street
Chicago, IL 60612

COPY

Attorneys at Law

11 South Wacker Drive
Suite 3000
Chicago, Illinois 60606-6677
Tel 312.360.6000

Statement No. 99772052(a)

Re: General
Client Matter ID No. 22148-0001

REVISED
FOR PROFESSIONAL SERVICES RENDERED AND EXPENSES INCURRED
THROUGH FEBRUARY 29, 2004:

FEEs FOR THIS STATEMENT	\$531.00
DISBURSEMENTS	<u>0.00</u>
TOTAL AMOUNT OF CURRENT STATEMENT	531.00
BALANCE DUE	<u>\$531.00</u>

*PAYMENT DUE UPON RECEIPT.
INTEREST OF 1.5% PER MONTH WILL BE ADDED AFTER 30 DAYS.*

JT-APP 2812

Freeborn & Peters LLP

2

March 31, 2004

Statement No: 99772052(a)

For professional services rendered with regard to:

Re: General

Feb 17, 2004	JS	Calls from Leslie regarding UK supplier and Precor.	1.50
Feb 20, 2004	JS	Review fax regarding concentric terms of sale; call from Leslie.	0.30

FEE SUMMARY

<u>TIMEKEEPER</u>	<u>HOURS</u>	<u>RATE</u>	<u>FEES</u>
Stiefel, John C.	1.80	295.00	\$531.0
TOTAL HOURS	1.80		
TOTAL FEES			<u>\$531.00</u>
TOTAL FEES AND DISBURSEMENTS			\$531.00

#603758

JT-APP 2813

Freeborn & Peters LLP

April 21, 2004

FEIN #36-3238755

Mr. Leslie Bortz
R.H. Peterson
2500 W. Arthington Street
Chicago, IL 60612

COPY

Attorneys at Law

Statement No. 99775698

111 South Wacker Drive
Suite 3000
Chicago, Illinois 60606-6677
Tel: 312.360.6000

Re: Patent
Client Matter ID No. 22148-0003

FOR PROFESSIONAL SERVICES RENDERED AND EXPENSES INCURRED
THROUGH MARCH 31, 2004:

Chicago

Springfield

FEES FOR THIS STATEMENT	\$25.00
DISBURSEMENTS	<u>3.00</u>
TOTAL AMOUNT OF CURRENT STATEMENT	28.00
BALANCE DUE	<u>\$28.00</u>

**PAYMENT DUE UPON RECEIPT.
INTEREST OF 1.5% PER MONTH WILL BE ADDED AFTER 30 DAYS.**

JT-APP 2814

Freeborn & Peters LLP

2

April 21, 2004

Statement No: 99775698

For professional services rendered with regard to:

Re: Patent

Mar 25, 2004 NBK Review case file and prepare order regarding 0.20
damages award for Lee Hutchinson review

FEE SUMMARY

<u>TIMEKEEPER</u>	<u>HOURS</u>	<u>RATE</u>	<u>FEES</u>
Kcough, Nora B	0.20	125.00	\$25.00
TOTAL HOURS	0.20		
TOTAL FEES			<u>\$25.00</u>

DISBURSEMENTS

Mar 30, 2004 FIRM Photocopying 3.00

DISBURSEMENT SUMMARY

Photocopying	3.00
TOTAL DISBURSEMENTS	<u>\$3.00</u>
TOTAL FEES AND DISBURSEMENTS	<u>\$28.00</u>

#607933

JT-APP 2815

Freeborn & Peters LLP

May 14, 2004

FEIN #36-3238755

Mr. Leslie Bortz
R.H. Peterson
2500 W. Arthington Street
Chicago, IL 60612

COPY

neys at Law

Statement No. 99778317

South Wacker Drive
3000
Chicago, Illinois 60606-6677
12 360 6000

Re: Patent
Client Matter ID No. 22148-0003

FOR PROFESSIONAL SERVICES RENDERED AND EXPENSES INCURRED
THROUGH APRIL 30, 2004:

ngo

FEES FOR THIS STATEMENT	\$4,704.50
DISBURSEMENTS	<u>1.00</u>

igfield

TOTAL AMOUNT OF CURRENT STATEMENT	4,705.50
-----------------------------------	----------

BALANCE DUE	<u>\$4,705.50</u>
-------------	-------------------

PAYMENT DUE UPON RECEIPT.
INTEREST OF 1.5% PER MONTH WILL BE ADDED AFTER 30 DAYS.

JT-APP 2816

Freeborn & Peters LLP

2

May 14, 2004

Statement No: 99778317

For professional services rendered with regard to:

Re: Patent

Apr 21, 2004	LWH	Review decision; conference regarding same; draft memo analyzing same; legal research regarding damages.	1.80
Apr 21, 2004	JF	Review of Federal Circuit decision; office conference with Lee Hutchinson; review of file regarding next steps and strategy; review and revise memorandum to John Stiefel regarding status and strategy; office conference with David Becker regarding decision.	2.90
Apr 22, 2004	LWH	Telephone conference with former counsel and draft email.	0.90
Apr 23, 2004	JS	Call from Leslie last night.	0.30
Apr 26, 2004	JS	Call from Leslie Bortz.	0.30
Apr 26, 2004	LWH	Email regarding meeting.	0.30
Apr 27, 2004	JS	Conference with Leslie Bortz and Lee Hutchinson.	2.50
Apr 28, 2004	LWH	Meet with Leslie Bortz and prepare for same.	2.10
Apr 30, 2004	LWH	Work on post appeal budget and research.	1.60

FEE SUMMARY

<u>TIMEKEEPER</u>	<u>HOURS</u>	<u>RATE</u>	<u>FEES</u>
Fitzgerald, Jennifer L.	2.90	325.00	\$942.50
Stiefel, John C.	3.10	295.00	\$914.50
Hutchinson, Leland W.	6.70	425.00	\$2,847.50
TOTAL HOURS	12.70		
TOTAL FEES			<u>\$4,704.50</u>

DISBURSEMENTS

Apr 26, 2004	FIRM	Photocopying	1.00
--------------	------	--------------	------

JT-APP 2817

Freeborn & Peters LLP

3

May 14, 2004

DISBURSEMENT SUMMARY

Photocopying	1.00
TOTAL DISBURSEMENTS	<u>\$1.00</u>
TOTAL FEES AND DISBURSEMENTS	\$4,705.50

#611577

JT-APP 2818

Freeborn & Peters LLP

June 25, 2004

FEIN #36-3238755

Mr. Leslie Bortz
R.H. Peterson
2500 W. Arthington Street
Chicago, IL 60612

COPY

Attorneys at Law

Statement No. 99781912

11 South Wacker Drive
Suite 3000
Chicago, Illinois 60606-6677
Tel 312.360.6000

Re: Patent
Client Matter ID No. 22148-0003

FOR PROFESSIONAL SERVICES RENDERED AND EXPENSES INCURRED
THROUGH MAY 31, 2004:

Chicago
Springfield

FEEES FOR THIS STATEMENT	\$21,730.00
DISBURSEMENTS	<u>58.87</u>
TOTAL AMOUNT OF CURRENT STATEMENT	21,788.87
BALANCE DUE	<u>\$21,788.87</u>

*PAYMENT DUE UPON RECEIPT.
INTEREST OF 1.5% PER MONTH WILL BE ADDED AFTER 30 DAYS.*

JT-APP 2819

Freeborn & Peters LLP

2

June 25, 2004

Statement No: 99781912

For professional services rendered with regard to:

Re: Patent

May 3, 2004	LWH	Draft motion to obtain bond release.	2.10
May 5, 2004	LWH	Conference regarding budget and motion regarding bond return.	1.30
May 7, 2004	LWH	Telephone conference with bond motion.	0.60
May 12, 2004	LWH	Conference regarding proposed findings and conclusions.	0.90
May 14, 2004	DSB	Revise and prepare for filing motion for return of cash security.	1.60
May 14, 2004	LWH	Conference regarding bond motion proposed findings and conclusions research.	1.60
May 14, 2004	JF	Office conferences with Lee Hutchinson and David Becker regarding scheduling and strategy; draft outline for statement of facts and conclusions of law.	4.60
May 17, 2004	JF	Draft statement of facts and conclusions of law.	2.80
May 18, 2004	DSB	Finalize motion for return of cash security; work on findings of fact.	2.70
May 18, 2004	JF	Draft statement of facts and conclusions of law.	1.70
May 19, 2004	DSB	Draft damages insert for findings of fact; office conferences with Jennifer Fitzgerald regarding same.	3.90
May 19, 2004	JF	Draft proposed statement of facts and conclusions of law; office conference with David Becker regarding the same.	4.10
May 20, 2004	DSB	Draft damages insert for findings of fact, office conferences with Jennifer Fitzgerald regarding same.	4.10
May 20, 2004	JF	Draft conclusions of law and statement of facts; review of record on appeal.	3.00
May 21, 2004	JF	Draft findings of fact and conclusions of law.	2.80
May 24, 2004	LWH	Conference regarding proposed findings.	0.90
May 24, 2004	JF	Draft proposed findings of fact; meeting with Lee Hutchinson regarding status and strategy.	2.30
May 25, 2004	LWH	Work on Proposed conclusions of law.	2.10

JT-APP 2820

Freeborn & Peters LLP

3

June 25, 2004

May 25, 2004	JF	Office conference with Lee Hutchinson regarding strategy; review of statement of fact and edit the same.	0.60
May 26, 2004	LWH	Work on proposed conclusions and findings.	7.30
May 26, 2004	JF	Office conference with Lee Hutchinson regarding status and strategy; outline findings of fact issues.	0.40
May 27, 2004	DSB	Work on findings of fact; review draft conclusions of law.	2.30
May 27, 2004	LWH	Work on conclusions of law; legal research regarding patent issues.	7.60
May 27, 2004	JF	Draft findings of fact draft.	0.60
May 28, 2004	LWH	Conference regarding proposed findings and conclusions.	0.80
May 28, 2004	JF	Review and revise draft conclusions of law.	0.90

FEE SUMMARY

<u>TIMEKEEPER</u>	<u>HOURS</u>	<u>RATE</u>	<u>FEES</u>
Fitzgerald, Jennifer L.	23.80	325.00	\$7,735.00
Becker, David S.	14.60	225.00	\$3,285.00
Hutchinson, Leland W.	25.20	425.00	\$10,710.00
TOTAL HOURS	63.60		
TOTAL FEES			<u>\$21,730.00</u>

DISBURSEMENTS

May 14, 2004	FIRM	Photocopying	1.80
May 26, 2004	LWH	Computer Legal Research - Westlaw 05/04 Westlaw Charges	30.87
May 28, 2004	FIRM	Photocopying	26.20

JT-APP 2821

Freeborn & Peters LLP

4

June 25, 2004

DISBURSEMENT SUMMARY

Computer Legal Research - Westlaw	30.87
Photocopying	28.00
TOTAL DISBURSEMENTS	<u>\$58.87</u>

TOTAL FEES AND DISBURSEMENTS	\$21,788.87
------------------------------	-------------

#619177

JT-APP 2822

Freeborn & Peters LLP

July 16, 2004

COPY

Mr. Leslie Bortz
R.H. Peterson
2500 W. Arthington St.
Chicago, IL 60612

Attorneys at Law

311 South Wacker Drive
Suite 3000
Chicago, Illinois
60606-6677
Tel 312.360.6000

John C. Stiefel
Partner
Direct 312.360.6274
Fax 312.360.6573
jstiefel
@freebornpeters.com

Re: *Statement for Services Through June 2004*

Dear Leslie:

Enclosed please find this firm's invoices for services rendered for the period ending June 30, 2004.

Should you have any questions, please do not hesitate to call.

Sincerely,

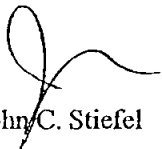

John C. Stiefel

Chicago

Springfield

JCS/dvs
Enc.

#530871v16

JT-APP 2823

Freeborn & Peters LLP

July 16, 2004

FEIN #36-3238755

Mr. Leslie Bortz
R.H. Peterson
2500 W. Arthington Street
Chicago, IL 60612

Attorneys at Law

1 South Wacker Drive
Suite 3000
Chicago, Illinois 60606-6677
Tel: 312.360.6000

Statement No. 99785527

Re: Patent
Client Matter ID No. 22148-0003

FOR PROFESSIONAL SERVICES RENDERED AND EXPENSES INCURRED
THROUGH JUNE 30, 2004:

Chicago

Springfield

FEES FOR THIS STATEMENT	\$24,171.50
DISBURSEMENTS	<u>1,672.48</u>
TOTAL AMOUNT OF CURRENT STATEMENT	25,843.98
BALANCE DUE	<u>\$25,843.98</u>

PAYMENT DUE UPON RECEIPT.
INTEREST OF 1.5% PER MONTH WILL BE ADDED AFTER 30 DAYS.

JT-APP 2824

July 16, 2004

Statement No: 99785527

For professional services rendered with regard to:

Re: Patent

Jun 1, 2004	LWH	Conference regarding proposed findings and telephone conference with Leslie Bortz.	0.70
Jun 2, 2004	DSB	Work on findings of fact and conclusions of law.	1.70
Jun 2, 2004	LWH	Work on Proposed Findings and Conclusions.	3.40
Jun 3, 2004	DSB	Work on findings of fact and conclusions of law.	2.20
Jun 3, 2004	LWH	Work on proposed findings and conclusions.	5.40
Jun 4, 2004	DSB	Work on findings of fact and conclusions of law; prepare pro hac paper work.	3.20
Jun 4, 2004	LWH	Draft proposed findings.	4.30
Jun 5, 2004	DSB	Work on findings of fact and conclusions of law.	5.40
Jun 6, 2004	DSB	Work on findings of fact and conclusions of law.	3.60
Jun 7, 2004	DSB	Work on findings of fact and conclusions of law.	1.80
Jun 7, 2004	LWH	Draft proposed findings of fact and conclusions.	6.50
Jun 8, 2004	DSB	Work on findings of fact and conclusions of law; office conferences with Lee Hutchinson regarding same.	6.70
Jun 8, 2004	JF	Review and revise statement of facts and conclusions of law.	2.00
Jun 8, 2004	LWH	Finalize Proposed Findings and Conclusions.	6.50
Jun 9, 2004	JW	Perform cite check for brief per David Becker's request.	2.00
Jun 9, 2004	DSB	Work on findings of fact and conclusions of law; office conferences with Lee Hutchinson regarding same; finalize pro hac applications.	5.90
Jun 9, 2004	MJP	Assist David Becker with research and cite checking of findings and conclusions regarding damages.	3.30
Jun 9, 2004	LWH	Finalize Proposed Findings and conclusions; email to co-counsel.	5.20
Jun 10, 2004	LWH	Attention to findings; revise same regarding willfulness.	4.80
Jun 11, 2004	LWH	Review Opponent's proposed findings.	0.80

Freeborn & Peters LLP

3

July 16, 2004

FEE SUMMARY

<u>TIMEKEEPER</u>	<u>HOURS</u>	<u>RATE</u>	<u>FEES</u>
Fitzgerald, Jennifer L.	2.00	325.00	\$650.00
Becker, David S.	30.50	225.00	\$6,862.50
Whittington, Jennifer	2.00	125.00	\$250.00
Pope, Maryjo	3.30	130.00	\$429.00
Hutchinson, Leland W.	37.60	425.00	\$15,980.00
TOTAL HOURS	75.40		
TOTAL FEES			<u>\$24,171.50</u>

DISBURSEMENTS

Jun 9, 2004	MJP	Computer Legal Research - Westlaw 06/04 Westlaw Charges	1,522.73
Jun 9, 2004	JW	Computer Legal Research - LEXIS 06/04 LexisNexis Charges	132.15
Jun 10, 2004	LWH	Computer Legal Research - Westlaw 06/04 Westlaw Charges	15.40
Jun 28, 2004	FIRM	Photocopying	2.20

DISBURSEMENT SUMMARY

Computer Legal Research - LEXIS	132.15
Photocopying	2.20
Computer Legal Research - Westlaw	1,538.13
TOTAL DISBURSEMENTS	<u>\$1,672.48</u>
TOTAL FEES AND DISBURSEMENTS	<u>\$25,843.98</u>

#621687

JT-APP 2826

Name of Attorney	Hours Billed	Billing Rate	Total Fees For Attorney
Leland W. Hutchinson, Jr.	225.9	\$395/hr. – applied to 156.4 hrs \$425/hr. – applied to 69.5 hrs.	\$91,315.50
John C. Stiefel	16.6	\$295/hr.	\$4,897.00
Jennifer L. Fitzgerald	275	\$295/hr. – applied to 246.3 hrs. \$325/hr. – applied to 28.7 hrs	\$81,986.00
David S. Becker	211	\$195/hr. – applied to 165.9 hrs. \$225/hr. – applied to 45.1 hrs.	\$42,498.00
Jonathan Coppess	58.9	\$165/hr. – applied to 9.7 hrs. \$185/hr. – applied to 86.9 hrs.	\$10,702.50
Tyra Holt	10	165/hr.	\$1,650.00
Janel (Dohrn) Clark	9.6	175/hr.	\$1,680.00
TOTAL	807	–	\$234,729.00

JT-APP 2827

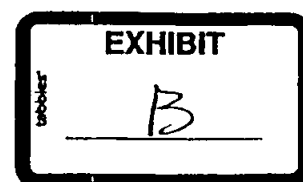

Type of Disbursement	Amount
Postage	N/A
Long distance phone	\$6.42
Photocopies	\$15,767.75
Travel	\$2,118.60
Express Mail Charges	\$930.16
Local Messenger Delivery	\$68.00
Paralegals	\$8,955.20
Computerized Legal Research	\$11,517.70
Facsimiles	\$50.00
TOTAL	\$39,413.83



CERTIFICATE OF CONFERENCE

I, David S. Becker, hereby certify that on July 22, 2004 a conference was held with counsel for the Plaintiff, to determine whether agreement could be reached with regard to the Court's award of Peterson's attorneys' fees in the amount of \$586,192.62. As a result of that conference, agreement could not be reached, accordingly, the matter is presented to the Court for determination.



David S. Becker

CERTIFICATE OF SERVICE

This certifies that a copy of the foregoing document was served by first-class mail, postage prepaid, to counsel for Plaintiff, William D. Harris, Jr., Schultz & Associates, P.C., 5400 LBJ Freeway, One Lincoln Center, Suite 525, Dallas, Texas 75240. and Charles Gaines, Hitt Gaines, P.C., 2435 North Central Plaza, Suite 1300, Richardson, Texas 75080, this 22nd day of July, 2004.

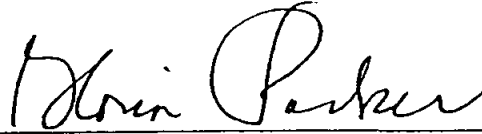

[Handwritten signature]

IN THE UNITED STATES DISTRICT COURT
NORTHERN DISTRICT OF TEXAS
DALLAS DIVISION

U.S. DISTRICT COURT
NORTHERN DISTRICT OF TEXAS
FILED
JUL 23 2004
CLERK, U.S. DISTRICT COURT
By _____
Deputy

GOLDEN BLOUNT, INC.

Plaintiff,

v.

ROBERT H. PETERSON CO.

Defendant.

§
§
§
§
§
§
§
§
§

Civil Action No. 3-01CV0127-R

(JURY TRIAL DEMANDED)

**DEFENDANT ROBERT H. PETERSON CO.'S OPPOSITION
TO PLAINTIFF'S MOTIONS TO AMEND FINDINGS,
FOR RECONSIDERATION AND FOR A NEW TRIAL**

Jerry R. Selinger
State Bar No. 18008250
JENKENS & GILCHRIST, A P.C.
1445 Ross Avenue, Suite 3200
Dallas, Texas 75202
214/855-4776 (Telephone)
214/855-4300 (Facsimile)
COUNSEL FOR DEFENDANT
ROBERT H. PETERSON CO.

OF COUNSEL:

Leland W. Hutchinson, Jr.
Jennifer L. Fitzgerald
David S. Becker
FREEBORN & PETERS, LLP
311 S. Wacker Dr., Suite 3000
Chicago, Illinois 60606
312/360-6000 (Telephone)
312/360-6572 (Facsimile)

TABLE OF CONTENTS

	<u>Page</u>
INTRODUCTION	1
ARGUMENT	3
I. THIS COURT LACKS JURISDICTION TO GRANT A NEW TRIAL.	3
II. PLAINTIFF OFFERS NO VALID GROUNDS FOR A NEW TRIAL.	4
III. THERE IS NO MANIFEST ERROR REGARDING PROOF OF DIRECT INFRINGEMENT WARRANTING AMENDMENT OF FINDINGS OR ALTERATION OF JUDGMENT.	8
A. THERE IS NO MANIFEST ERROR REGARDING DEMONSTRATIVE EXHIBITS.	10
B. DX 30 DOES NOT SHOW ANY DIRECT INFRINGEMENT BY PETERSON.	13
IV. THERE IS NO MANIFEST ERROR REGARDING PROOF OF INDIRECT INFRINGEMENT.	16
V. THERE IS NO MANIFEST ERROR REGARDING THE DAMAGES FINDINGS.	19
VI. THERE IS NO MANIFEST ERROR REGARDING THE EXCEPTIONAL CASE FINDINGS.	19
CONCLUSION.....	22

TABLE OF AUTHORITIES

FEDERAL CASES

Advance Transfer Co. v. Levinson,
837 F.2d 1081 (Fed.Cir. 1988).....21

Algren Watch Findings, Inc.,
197 F.2d 69 (2nd Cir. 1952).....21

American Train Dispatchers Ass'n. v. Norfolk and Western Ry. Co.,
627 F.Supp. 941 (N.D.Ind. 1985)9, 12, 19

Badalamenti v. Dunham's, Inc.,
896 F.2d 1359 (Fed.Cir. 1990).....21

Ball v. Interoceanica Corp.,
71 F.3d 73 (2nd Cir. 1995).....8

Barber v. Intern'l. Brotherhood of Boilermakers, et. al,
841 F.2d 1067 (11th Cir. 1988)3

Butler v. Pettigrew,
409 F.2d 1205 (7th Cir. 1969)5

Calderon v. Presidio Valley Farmers Ass'n.,
863 F.2d 384 (5th Cir. 1989)3

Celotex v. Catrett,
477 U.S. 317 (1986).....19

Diaz v. Methodist Hospital,
46 F.3d 492 (5th Cir. 1995)5

Dieblitz v. Arreola,
834 F.Supp. 298 (E.D.Wis. 1993).....10

Dondi Properties Corp. v. Commercial Savings and Loan Ass'n.,
121 F.R.D. 284 (N.D. Tex. 1988).....8

Dow Chemical Pacific, Ltd. v. Rascator Maritime, S.A.,
609 F.Supp. 451 (S.D.N.Y. 1984)9

Eltech Systems Corp. v. PPG Industries, Inc.,
903 F.2d 805 (Fed.Cir. 1990).....21

Farm Credit bank of Texas v. Guidry,
110 F.3d 1147 (5th Cir. 1997)5

Federal Deposit Ins. Corp. v. Cage,
810 F.Supp. 745 (S.D.Miss. 1993).....10

Fontenot v. Mesa Petroleum Co.,
791 F.2d 1207 (5th Cir. 1986)9

Golden Blount, Inc. v. Robert H. Peterson Co.,
365 F.3d 1054 (Fed.Cir. 2004).....4, 5, 17, 18

Jarvis v. Wal-Mart Stores, Inc.,
161 F.R.D. 337 (N.D. Miss. 1995).....4

Local 285 v. Nonotuck Resource Assocs.,
64 F.3d 735 (1st Cir. 1995).....22

Loctite Corp. v. Fel-Pro, Inc.,
667 F.2d 577 (7th Cir. 1981)21

Lyons v. Jefferson Bank & Trust,
793 F.Supp. 989 (D.Colo. 1992).....9, 12, 20

Martinez v. Bally's Louisiana, Inc.,
244 F.3d 474 (5th Cir. 2001)14, 15, 17

Mays v. Burgess,
152 F.2d 123 (D.C. Cir. 1945).....3

Medcom Holding Co. v. Baxter Travenol Labs., Inc.,
106 F.3d 1388 (7th Cir. 1997)15, 17

Mercy v. County of Suffolk, New York,
748 F.2d 52 (2nd Cir. 1984).....5

Nucor Corp. v. Nebraska Public Power District,
999 F.2d 372 (8th Cir. 1993)8

Owens v. International Paper Co.,
528 F.2d 606 (5th Cir. 1976)5

Popeil Brothers, Inc. v. Shick Electric, Inc.,
516 F.2d 772 (7th Cir. 1975)5

Porter v. Farmer's Supply Service, Inc.,
790 F.2d 882 (Fed. Cir. 1986).....21

Retired Chicago Police Assn. v. Firemen's Annuity and Benefit Fund of Chicago,
145 F.3d 929 (7th Cir. 1998)21

Riley v. Northwestern Bell Telephone Co.,
1 F.3d 725 (8th Cir. 1993)9

<i>Sibbald v. United States</i> , 37 U.S. 488 (1838).....	3, 4
<i>Soo Line R.R. Co. v. St. Louis Southwestern Ry. Co.</i> , 125 F.3d 481 (7th Cir. 1997)	15, 17
<i>St. Paul Mercury Ins. Co. v. Fair Ground Corp.</i> , 123 F.3d 336 (5th Cir. 1997)	9
<i>Ted Lapidus S.A. v. Vann</i> , 112 F.3d 91 (2nd Cir. 1997).....	21
<i>U.S. v. Hernandez-Herrera</i> , 952 F.2d 342 (10th Cir. 1991), cited in Conclusion 30	11
<i>United States Fidelity & Guaranty Co. v. Baker Material Handling Corp.</i> , 62 F.3d 24 (1st Cir. 1995) affirmed: "the	7
<i>Wallace v. Brown</i> , 485 F.Supp. 77 (S.D.N.Y. 1979).....	9
<i>Waltman v. International Paper Co.</i> , 875 F.2d 468 (5th Cir. 1989).....	10

STATUTES

35 U.S.C., § 285.....	21, 22
Fed.R.Civ.P. 52.....	4, 8-10, 19
Fed.R.Civ.P. 7.....	9
Fed.R.Civ.P. 11	21, 22
Fed.R.Civ.P. 26.....	6
Fed.R.Civ.P. 37	5
Fed.R.Civ.P. 59.....	1, 9, 10
Fed.R.Civ.P.60.....	8

IN THE UNITED STATES DISTRICT COURT
NORTHERN DISTRICT OF TEXAS
DALLAS DIVISION

GOLDEN BLOUNT, INC.

Plaintiff,

v.

ROBERT H. PETERSON CO.

Defendant.

§
§
§
§
§
§
§
§
§

Civil Action No. 3-01CV0127-R

(JURY TRIAL DEMANDED)

**DEFENDANT ROBERT H. PETERSON CO.'S OPPOSITION
TO PLAINTIFF'S MOTIONS TO AMEND FINDINGS,
FOR RECONSIDERATION AND FOR A NEW TRIAL¹**

INTRODUCTION

Plaintiff has provided this Court with no reason to grant any relief.² Its motion for a new trial cannot be considered because the Federal Circuit's mandate is narrowly limited to entering new findings on the existing record. No jurisdiction exists to retry the case. Moreover, plaintiff has stated no valid ground for a new trial. After voluntarily accepting a stipulation in lieu of customer discovery, it now wants to renege on its agreement. That is no reason for a retrial.

Plaintiff's request for reconsideration is also without merit. Motions for reconsideration are heard under Rule 59(e), F.R.Civ.P. Both Rules 52(b) and 59(e) permit only consideration of new law, newly discovered evidence or correction of manifest errors of law or fact. Amendment of findings is warranted only if the outcome changes. This plaintiff argues no new law, offers no

¹ The Appendix attached hereto as Exhibit A responds to those challenges to the Court's Findings of Fact that are not more fully addressed herein.

² We will use the following abbreviations: Plaintiff's Motions ("Pltfs. Mot."); Plaintiff's Memorandum ("Pltfs. Br."); Plaintiff's Appendix attached to its Memorandum ("Pltfs. App."); Plaintiff's Trial Exhibit ("PX"); Defendant's Trial Exhibit ("DX"); Court's Findings specifically challenged by plaintiff ("Finding [#]"); Court's Findings not specifically challenged by plaintiff ("Uncontested Finding [#]"); Court's Conclusions ("Conclusion [#]"); Plaintiff's Proposed Findings ("Pltfs. Prop. Finding [#]") and Trial Transcript ("[Vol. #], Tr. [Pg. #]"). We will cite to other filed pleadings by name and to depositions by witness name, volume and page.

new evidence and claims no manifest error. It merely disagrees with the Court's findings and seeks, improperly, to relitigate them.

Plaintiff's narrow infringement argument is based entirely on two incorrect assertions. First, its demonstrative exhibits gain no probative value just by being admitted. Regardless of admission, there is still no underlying evidence that any of them illustrate any Peterson product.

Second, DX 30 is no evidence of infringement by anyone. Tod Corrin testified that DX 30 shows a "level" or "parallel" installation for the primary and secondary burners. 2 Tr. 173, 197-98. Plaintiff has now judicially admitted that such an installation does not infringe. See Finding 188 and Uncontested Finding 190. Even Golden Blount admitted that this drawing does not show the primary burner being at a "raised level" with respect to the secondary burner. Finding 109. Even though Blount later contradicted himself, believing his first statement over his second is not manifest error. Absent reversal of Finding 109, DX 30 cannot evidence infringement.

Moreover, DX 30 pertains only to Peterson's G 4 product. It shows nothing about Peterson's different G 5 product. See Uncontested Findings 18 to 21. No evidence shows that any of the 10 G 5 units with EMB's assembled by Peterson infringed the '159 patent.

Plaintiff's admission (Finding 188) that a level or higher EMB installation does not infringe also negates its contributory infringement claim because it admits substantial non-infringing uses for Peterson's EMB product. The sole remaining claim is induced infringement. Plaintiff, however, cites no evidence: (1) that DX 30 specifically was sent to anyone, (2) that anyone infringed because of it, (3) that Peterson believed that DX 30 taught how to infringe or (4) how many such infringements supposedly occurred. Absent proof of each of these essential elements, the induced infringement claim was rightly decided in Peterson's favor.

Finally, there was no error in awarding Peterson attorney's fees. A patent plaintiff who unreasonably assesses proof of infringement has acted in bad faith, rendering the case exceptional and warranting an attorney's fees award. Here, the discovery conference on October 5, 2001 shows clearly that plaintiff was then well aware of its problems proving infringement. The sole proof of infringement upon which it now rests its motions (DX 30) was not created until several months later. Plaintiff had nothing and knew it, but went to trial anyway. Such conduct, standing alone, warrants a finding of bad faith and an attorney's fees award.

ARGUMENT

I. THIS COURT LACKS JURISDICTION TO GRANT A NEW TRIAL.

The district court loses general jurisdiction over a case when it is appealed. On remand, the district court's jurisdiction is necessarily limited to carrying out the mandate:

The inferior court is bound by the [appellate court's] decree as the law of the case; and must carry it into execution, according to the mandate. They cannot vary it, or examine it for any other purpose than execution; or give any other or further relief; or review it upon any matter decided on appeal for error apparent; or intermeddle with it, further than to settle so much as has been remanded.

Sibbald v. United States, 37 U.S. 488, 492 (1838). See also *Calderon v. Presidio Valley Farmers Ass'n.*, 863 F.2d 384, 387 (5th Cir. 1989) (Reversed: "We remanded the case to allow the district court to redetermine damages [for a specific violation]. We did not reopen the legal theory involved."); *Barber v. Intern'l. Brotherhood of Boilermakers, et. al.*, 841 F.2d 1067, 1070 (11th Cir. 1988) ("where an appellate court remands for 'resolution of a narrow factual issue,' the lower court may not circumvent the mandate by approaching the identical legal issue under an entirely new theory."); *Mays v. Burgess*, 152 F.2d 123, 124 (D.C. Cir. 1945) (On remand, "the District Court had no jurisdiction, except to carry out the mandate of this court").

In this case, the Federal Circuit's mandate has limited the remand to a single task:

We thus vacate those portions of the district court's opinion and remand *for specific factual findings*. * * * On remand, the district court "shall find facts separately and state specifically its conclusions of law thereon." Fed.R.Civ.P. 52(a).

Golden Blount, Inc. v. Robert H. Peterson Co., 365 F.3d 1054, 1061 (Fed.Cir. 2004) (Emphasis added). Although district courts may reopen the record when a case has been remanded "generally" or for "further proceedings," no jurisdiction exists to do so where, as here, the case has been remanded only for the entry of specific findings and conclusions. Because granting a new trial would exceed the appellate court's mandate, it would qualify as the "other or further relief" forbidden by *Sibbald*.

II. PLAINTIFF OFFERS NO VALID GROUNDS FOR A NEW TRIAL.

On remand, for the first time, plaintiff now seeks to reopen discovery, to compel answers about Peterson's customers, presumably to depose a group of them and then to retry the case. Even if jurisdiction existed to consider such relief, plaintiff advances no recognized ground warranting granting it.

This Court's March 20, 2001 Scheduling Order required all discovery to be *completed* by September 14, 2001. Completion of discovery necessarily includes discovery compelled by motion. *See Jarvis v. Wal-Mart Stores, Inc.*, 161 F.R.D. 337, 338 (N.D. Miss. 1995) (Motion to compel filed at pretrial conference after discovery cut-off: "plaintiff is technically barred from raising the issue of defendant's non-compliance"). The cut-off was extended once, to October 5. After October 5, 2001, discovery was complete and any motion to compel became untimely.

Despite having taken no customer discovery, plaintiff elected to proceed to trial, thus waiving any motion to compel discovery:

The motion [to compel discovery] should be deemed waived if it is not made prior to judgment ... Indeed, the motion should normally be deemed waived if it is not made prior to trial.

Mercy v. County of Suffolk, New York, 748 F.2d 52, 55 (2nd Cir. 1984). *Accord, Popeil Brothers, Inc. v. Shick Electric, Inc.*, 516 F.2d 772, 778 (7th Cir. 1975) (“Rule 37(c) expenses and fees must be timely sought prior to judgment and appeal, and ... if the judgment is silent in regard thereto, they are deemed waived or denied”); *Butler v. Pettigrew*, 409 F.2d 1205, 1207 (7th Cir. 1969) (Motion to compel first presented after trial: “We think plaintiffs by their own inaction, waived the rights” to seek further discovery).

Plaintiff now seeks a new trial arguing that, if discovery is reopened, it might find evidence of customer infringement. It is sheer speculation that it further discovery would, in fact, reveal any.³

Where a new trial is sought because of newly discovered evidence, the burden is on the movant to show that the evidence “could not have been discovered earlier by proper diligence.” *Farm Credit bank of Texas v. Guidry*, 110 F.3d 1147, 1154 (5th Cir. 1997). *Accord, Diaz v. Methodist Hospital*, 46 F.3d 492, 495 (5th Cir. 1995). The movant must show “that they were excusably ignorant of this information until after trial.” *Owens v. International Paper Co.*, 528 F.2d 606, 611 (5th Cir. 1976). This plaintiff makes no effort to even argue excusable neglect or its own diligence. That omission, standing alone, is fatal to its new trial motion.

To sustain its indirect infringement claims, plaintiff was required to prove infringement by a Peterson customer or third party using Peterson products. *See Golden Blount*, 365 F.3d at 1061. Plaintiff’s counsel filed proposed jury instructions which clearly show its awareness of this rule. If plaintiff needed to make use of the discovery process (as opposed to its own pre-

³ DX 30 shows that the fireplace floor limits how low the EMB can be installed. Finding 162. In the lowest possible position, that exhibit shows that the top of the EMB secondary burner could be no more than 0.06 inch below the top of the G 4 primary burner. Six One Hundredths of an inch, however, is an extremely tight clearance. Any Peterson customer who installed the EMB even 1/16th inch (.0625”) higher than the lowest possible position—to obtain clearance to turn the valve with one’s fingers, for instance—would make a non-infringing installation. Finding 188; Uncontested Finding 190. In all probability, most, if not all, of Peterson’s customers did not opt for the lowest possible installation position.

filing investigation) to find such evidence, the most basic level of due diligence would have required the filing of a timely motion to compel.⁴

Critically, plaintiff stops well short of charging Peterson's it "did trial counsel with any violation of the discovery rules. Plaintiff merely notes that not challenge defendant's objection" to customer discovery after meeting and conferring with Mr. Monco. Pltfs. Br. at 9. Plaintiff never suggests that Peterson's position was wrongful.⁵ In truth, plaintiff was not interested in proving indirect infringement one customer at a time. On October 5, 2001 (the final extended discovery cut-of day), in a conference held during the Bortz deposition, plaintiff's counsel said: "Well, we don't want anything from the customers. We don't want that. But you know there's a rule that says you can't have contributory infringement without there being a direct infringement."⁶ Bortz Dep., Vol. 1, p. 165.

Proving indirect infringement one customer at a time would have been expensive and would necessarily have limited plaintiff's damages to a single recovery per infringement proved. To avoid these problems, plaintiff tried to prove indirect infringement solely by arguing that Peterson's EMB was not a "staple article of commerce" (*i.e.*, a product capable of non-infringing use). See Plaintiff's Issue Directed Trial Brief, p. 4. That this tactic failed is not Peterson's fault.

⁴ The industry in which plaintiff and Peterson compete is a small one, well known to both. Plaintiff does not claim that it did not know and could not have learned without discovery, the identities of several Peterson dealers who it could have subpoenaed. Peterson's internet web site (www.rhpeterson.com) includes on its opening page a link labeled "locate dealers" which takes anyone to a page where, by putting in a zip code, they obtain contact information for local Peterson dealers. After taking such discovery, plaintiff could also have presented expert testimony projecting infringing installations based on a sample of actual Peterson EMB installations surveyed by the expert. Plaintiff did none of these things prior to trial.

⁵ In responding to Plaintiff's Interrogatories and Document Requests, Peterson stated that it would produce the actual customer (not dealer) information if subject to a suitable protective order. This position is eminently reasonable in litigation between direct competitors. Rule 26(c), F.R.Civ.P.

⁶ Because of this Court's scheduling order requiring discovery to be *completed* by the cut-off day, plaintiff necessarily placed itself at a disadvantage by waiting until the final day of discovery to resolve differences about Peterson's customer list. There was no time to have taken any follow up discovery based on any list plaintiff would have obtained.

To solve its own problem and to resolve Peterson's customer confidentiality objection, plaintiff obtained a stipulation from Peterson. Substitute Statement of Stipulated Facts, ¶ 6. The stipulation, however, does not prove infringement because it says nothing about the secondary burner tube being installed "below" the primary burner pipe or the primary burner pipe being installed at a "raised level." Regardless, the stipulation was what plaintiff voluntarily accepted in lieu of customer discovery. *See* Bortz Dep., Vol. 1, p. 166.⁷

Contrary to plaintiff's argument, Peterson did not promise to provide a product "to establish the relevant heights of the burner[s]."⁸ Pltfs. Br. at 9. Peterson's counsel sent plaintiff the requested G-4 primary burner on October 30, 2001. (*See* transmittal letter, attached as Exhibit C). Plaintiff already had an EMB in its possession. (Bortz Dep. Vol. 1, p. 167). Thus, the record is clear that Peterson did not send plaintiff an assembled two burner apparatus. If the parties had agreed that the product Peterson agreed to provide would reflect an assembly as sold by Peterson or as assembled by Peterson customers, Peterson would have provided the entire unit. Moreover, such an agreement would certainly have been affirmatively stated in the Stipulation prepared by plaintiff. The Stipulation's silence on the subject shows plaintiff's claims about the scope of the parties' discovery agreement are recent creations.

Even a *clearly* established discovery violation does not constitute "newly discovered evidence" warranting a new trial. *United States Fidelity & Guaranty Co. v. Baker Material Handling Corp.*, 62 F.3d 24, 29 (1st Cir. 1995) (denial of new trial sought under Rules 59 and

⁷ Plaintiff's counsel actually did not present the proposed stipulation until almost four months later. (*See* copy of transmittal letter dated January 31, 2002, attached hereto as Exhibit B).

⁸ Plaintiff argues that a new trial is warranted because "*In effect ...* Dean Monco represented ..." what the product to be provided by Peterson would show. Pltfs. Br. at 9 (emphasis added). There is no dispute, however, that Mr. Monco made no such representation *in fact*. All he agreed to do was to provide plaintiff the Peterson product that plaintiff requested, a promise quickly performed without objection. The statements made by Mr. Monco at the Bortz deposition involve no misrepresentation warranting a new trial.

60(b)(3) affirmed: “the appropriate remedy for parties who uncover discovery violations is ‘not to seek reversal after an unfavorable verdict but a request for continuance at the time the surprise occurs.’”). There is no such discovery violation here. Certainly, a good faith agreement of counsel resolving a meritorious confidentiality issue cannot be the grounds for a new trial merely because one side misapprehended whether the Stipulation and product example it bargained for would be sufficient, standing alone, to sustain its burden of proof. *See Dondi Properties Corp. v. Commercial Savings and Loan Ass’n*, 121 F.R.D. 284, 289 (N.D. Tex. 1988) (“the rules dealing with discovery in federal cases are to be self-executing”). Peterson has a right to rely on the agreed resolution of its discovery objection. Plaintiff may not back out of that agreement just because, in hindsight, it would now rather make a different choice. *Ball v. Interoceanica Corp.*, 71 F.3d 73, 76 (2nd Cir. 1995) (quoting MOORE’S FED. PRAC.: “A trial court should not grant a new trial merely because the losing party can probably present a better case on another trial.”).

Plaintiff cites no error of law which excluded any relevant evidence. Peterson never promised plaintiff that it would stipulate to customer infringement or to the vertical positioning of the two burner tubes. It never misled plaintiff or its counsel.

Finally, plaintiff has failed to move for such relief within a reasonable time. Rule 60(b)(3), F.R.Civ.P. Raising the issue for the first time on remand after appeal is not timely. *Nucor Corp. v. Nebraska Public Power District*, 999 F.2d 372 (8th Cir. 1993) (Rule 60(b) motion raised for first time on remand untimely absent showing of exceptional circumstances).

III. THERE IS NO MANIFEST ERROR REGARDING PROOF OF DIRECT INFRINGEMENT WARRANTING AMENDMENT OF FINDINGS OR ALTERATION OF JUDGMENT.

Plaintiff has filed two motions: one seeking to amend the Court’s findings under Rule 52(b) and the other for “reconsideration.” Because federal practice does not recognize a motion

for reconsideration, plaintiff's second motion must be decided under Rule 59(e), F.R.Civ.P. *St. Paul Mercury Ins. Co. v. Fair Ground Corp.*, 123 F.3d 336, 339 (5th Cir. 1997).

The sole purpose of a motion to amend findings "is to correct manifest errors of law or fact or, in some limited situations, to present newly discovered evidence." *Fontenot v. Mesa Petroleum Co.*, 791 F.2d 1207, 1219-20 (5th Cir. 1986) ("Blessed with the acuity of hindsight, [movant] may now realize that it did not make its initial case as compellingly as it might have, but it cannot charge the District Court with responsibility for that failure through this Rule 52(b) motion"). A motion to amend findings should not be "employed to introduce new evidence that was available at trial but was not proffered, to relitigate old issues, to advance new theories, or to secure a rehearing on the merits."⁹ *Id.*

When considering a motion to amend findings, the existing findings are presumed valid and correct.¹⁰ *Wallace v. Brown* 485 F.Supp. 77, 79 (S.D.N.Y. 1979). No amendment to these findings is warranted unless it would change the outcome of the case. *Lyons v. Jefferson Bank & Trust*, 793 F.Supp. 989, 991 (D.Colo. 1992) ("a motion to amend should not be granted where the proposed additional findings of fact are not material to the district court's conclusions"); *American Train Dispatchers Ass'n. v. Norfolk and Western Ry. Co.*, 627 F.Supp. 941, 948 (N.D.Ind. 1985) (no need to amend if "the proposed change in the October 1 order would have no effect on its decision"); *Dow Chemical Pacific, Ltd. v. Rascator Maritime, S.A.*, 609 F.Supp.

⁹ Ignoring the rules stated in *Fontenot*, plaintiff has resubmitted its prior proposed findings and conclusions (with the exception of adding two new conclusions), asking the Court in its Motion to Amend to reverse itself and enter them. The relief sought by plaintiff's Motion to Amend is a bald request for relitigation of already presented and decided issues. As such, there is no choice but to deny it.

¹⁰ Clearly, any Uncontested Findings must be deemed valid. Both Rule 52(b) and 59(e) have jurisdictional 10 day time limits. Rule 7(b) requires motions to be filed in writing and to "state with particularity" the grounds warranting relief. Plaintiff may not now raise any arguments about Uncontested Findings which are not specifically included in the Motions. *Riley v. Northwestern Bell Telephone Co.*, 1 F.3d 725, 726-27 (8th Cir. 1993) (conclusory Rule 52(b) motion violated Rule 7(b); memorandum with particular arguments filed after 10 day time limit barred as untimely).

451, (S.D.N.Y. 1984) (“most of the grounds [for amendment] raised by Dr. Galin are irrelevant because they would not in any way affect the outcome of the case”).

Rule 59(e) motions are also a narrow opportunity to correct manifest errors of law or fact and not an opportunity to relitigate, rehear or reconsider issues or arguments which have already been raised and rejected. *Waltman v. International Paper Co.*, 875 F.2d 468, 473 (5th Cir. 1989); *Dieblitz v. Arreola*, 834 F.Supp. 298, 302 (E.D.Wis. 1993) (“Much like Rule 52(b) motions, Rule 59(e) motions ‘are not intended merely to relitigate old matters nor are such motions intended to present the case under new theories’”).

Merely disagreeing with the Court’s findings is insufficient “to demonstrate a ‘clear error of law’ or ‘manifest injustice.’” *Federal Deposit Ins. Corp. v. Cage*, 810 F.Supp. 745, 747 (S.D.Miss. 1993). This plaintiff does no more than disagree with the outcome. It offers no new evidence. It does not argue that the controlling law has changed. It has not even recognized the manifest error standard or argued why any of the Findings should be amended under that test.

Plaintiff raises only two challenges, both faulty: (1) that its demonstrative exhibits are probative because they were admitted into evidence without objection and (2) that DX 30 proves Peterson’s infringement. The first of these claims, as plaintiff itself has admitted, is not the law. The second seeks merely to relitigate the inferences allegedly arising from DX 30 which are both demonstrably incorrect and previously argued. *See* Pltfs. Prop. Findings 62 and 63.

A. THERE IS NO MANIFEST ERROR REGARDING DEMONSTRATIVE EXHIBITS.

Just because plaintiff’s demonstrative exhibits were admitted into evidence without objection does not make them probative of anything. Thus, Findings contrary to what these exhibits appear to state on their face are not thereby “clear error.” *See* Pltfs. Br. at 3-4; Pltfs.

App. at A-3 - A-4. As plaintiff itself has already conceded, admission of a demonstrative exhibit into evidence does not establish any probative value:

Certain charts and summaries have been received into evidence to illustrate information brought out in the trial. Charts and summaries are only as good as the underlying evidence which supports them. You should, therefore, only give them such weight as you think the underlying evidence deserves.

Plaintiff's Proposed Jury Instruction No. 19. Demonstrative exhibits admitted into evidence are still only as probative as the underlying evidence they are meant to illustrate. They have no separate meaning of their own. Conclusions No. 29-34. Because there was zero "underlying evidence" authenticating any of these demonstrative exhibits, they necessarily deserve zero weight. *U.S. v. Hernandez-Herrera*, 952 F.2d 342, 343 (10th Cir. 1991) ("the evidence is viewed as irrelevant unless the proponent can show that the evidence is what its proponent claims"), cited in Conclusion 30. Critically, plaintiff has not challenged these Conclusions as incorrect. Having no answer, plaintiff merely ignores them.

The only Finding about the documentary demonstrative exhibits which plaintiff specifically challenges is Finding 78 (no "witness authenticated [PX 9 "Literal Infringement Chart"] as accurately depicting any product made, used or sold by Peterson"). See Uncontested Findings 47-51 (videotape); 62-75 (photographs); 76-77 and 79-81 ("Literal Infringement Chart"); 82-88 ("Equivalence Chart") and 89-95 (side view drawings). Plaintiff's sole argument about PX 9 is its claim that Peterson's failure to object constituted a waiver. Pltfs. App. at A-4, Finding 37, incorporated into Finding 78 at A-5. No failure to object, however, can make PX 9 relevant to any pertinent issue. See Conclusions 29-34.

Plaintiff used PX 9 only with Blount, who did not authenticate it and admitted lacking the personal knowledge about how Peterson sold its products to be able to do so. See Uncontested Findings 79 and 99. Plaintiff cites no evidence affirmatively showing that the drawings in PX 9

labeled "Defendant's Sold Product" accurately reflect any Peterson product or products. Absent such evidence, PX 9 is irrelevant to any infringement claim.

Plaintiff is also wrong in claiming that PX 4A (assembled apparatus) shows anything relevant. Plaintiff does not dispute that it offered no foundation whatsoever for the exhibit, but cites solely the testimony of Peterson's witness, Vincent Jankowski.¹¹ See Pltfs. App. at A-4, Finding 58. Jankowski, however, never testified that PX 4A demonstrates how Peterson or anyone else assembles EMB's with primary burners (the sole relevant issue here). Critically, Jankowski did not say that Peterson ever made, used or sold an apparatus assembled in the form that PX 4A was presented in Court. See Uncontested Findings 146, 147 and 58 ("No substantial evidence shows that the burner tubes comprising [PX 4A] had been assembled by Peterson or by any Peterson dealer or customer in the configuration in which the apparatus appeared in court."). All that Mr. Jankowski said about PX 4A is that "I know the component parts. I've seen them." 2 Tr. 145. His testimony shows nothing about assembly in an infringing configuration.

At most, PX 4A shows that it is possible for Peterson's G 4 and EMB components to be assembled into an infringing combination. PX 4A, however, does not show that Peterson or any Peterson customer or anyone else (except plaintiff, of course) ever made, used or sold such an assembly. As such, Findings 53, 55, 57 and 59-61 are clearly correct.

As to Finding 56, Jankowski did not testify that the entire apparatus was Peterson's sold product, or was assembled by Peterson or any Peterson customer. At most, he identified PX 4A as consisting of Peterson components. No amended Finding is necessary, however, because that quibble cannot change the outcome of the Court's non-infringement conclusion. *Lyons, supra*; *American Train Dispatchers, supra*.

¹¹ Plaintiff did not even bother to establish that PX 4A incorporated the Peterson G 4 burner provided by counsel pursuant to agreement. Nor did it explain where the EMB secondary burner came from or who assembled them.

B. DX 30 DOES NOT SHOW ANY DIRECT INFRINGEMENT BY PETERSON.

DX 30 is a CAD drawing entitled “EMB G4 Reference #2.” Corrin testified that DX 30 shows “the relationship of the ember booster ... to the primary burner in the glowing ember burner G 4.” 2 Tr. 173. *See also* Uncontested Finding 152 (DX 30 shows “G 4” and “EMB” products). DX 30 is not Peterson’s usual installation instructions for the EMB. *See* PX 7 (usual installation instructions). It was not routinely distributed to anyone.

When asked about Peterson’s preferred installation configuration for EMB’s and G 4’s, Corrin explained, “You would want both burners to be parallel.” 2 Tr. 197-98. A “level” or “parallel” installation of the primary and secondary burner tubes does not infringe, as plaintiff now readily admits. *See* Finding 188 (“any installation of the ‘EMB’ product with its top level with or above the top of the primary burner” does not infringe Claims 1-16. Plaintiff’s response “True...” Emphasis added).¹² *See also* Uncontested Finding 190 (same for Claim 17).

DX 30 shows that the lowest possible installation of the EMB places the top of the secondary burner tube less than 1/16th of an inch below the top of the primary burner. Finding 162, 2 Tr. 198-201.¹³ Asked about the drawing, however, Corrin testified that DX 30 “shows the ember booster generally level to the main burner tube.” 2 Tr. 173. No evidence suggests that anyone at Peterson regarded DX 30 as showing an installation of the EMB “below” the G 4.

Significantly, when Blount was asked, “would you consider the primary tube to be raised relative to the secondary tube, given this picture,” [DX 30], his answer was, unequivocally, “No.” *See* Finding 109. Blount’s answer, of course, constitutes at least an evidentiary admission

¹² We omit the remainder of plaintiff’s rejoinder comment because it conveniently forgets who has the burden of proof. *See* Conclusion 1. Peterson was not required to prove the absence of infringement.

¹³ Plaintiff challenges Finding 162 as “irrelevant.” Pltffs. App. at A-9, Finding 162. Nowhere, however, does plaintiff dispute the accuracy of this statement.

that an EMB installation complying with DX 30 would not infringe the '159 Patent. *Martinez v. Bally's Louisiana, Inc.*, 244 F.3d 474, 476-77 (5th Cir. 2001). An evidentiary (as opposed to a judicial) admission may, of course, be contradicted or explained. Within a page of transcript, plaintiff's counsel did induce Blount to flip-flop, asserting that the primary tube shown in DX 30 was higher. 3 Tr. 37. Blount did not, however, attempt to withdraw his initial answer or claim it to be the product of mistake or misunderstanding. He simply gave two mutually exclusive and inconsistent answers, one of which clearly must be wrong.

When a witness self-contradicts, his original "testimonial statement remains as an item of proof which the jury is at liberty to accept or reject." 3A WIGMORE ON EVIDENCE, CHADBOURN REV., § 1018, n. 4, p. 995 (1972). The contradiction, with no claim of mistake, does not negate the original admission. Because the trier of fact was free to accept Finding 109 as correct despite Blount's contradiction, its decision to do so cannot constitute a manifest error warranting any amendment. Unless and until Finding 109 is amended for manifest error, Blount's admission that DX 30 does not show an infringing configuration, stands.

Moreover, even had Blount never made the admission and DX 30 were probative of both infringement and how Peterson intended its G 4 and EMB products to be assembled, it shows nothing whatsoever about Peterson's G 5 product. Uncontested Findings 18 to 21 show that Peterson's G 5 and G 4 are different products not manufactured by Peterson to the same standards or by the same methods. Peterson manufactures many different products. PX 24 (Bortz dep.) at 70 ("We probably show 50 different gas log sets" to distributors). The G 4 and G 5 are just two of these 50 different lines.

Plaintiff contests Finding 26, which states that no evidence shows that Peterson ever assembled a G 5 with an EMB in an infringing manner. Pltfs. App. at A-3, Finding 26. The sole

basis for this challenge, however, is Corrin's testimony about DX 30. *Id.* The argument necessarily fails because DX 30 shows nothing about Peterson's G 5 product. Findings 18-21; DX 30 (Title referencing "G 4") and 2 Tr. 173 (specifically referencing the "G 4;" nothing stated about the "G 5"). No evidence establishes that the vertical configuration shown for the G 4 product shown on DX 30 was ever applied to the different G 5 product. No evidence establishes that Peterson failed to assemble the G 5—EMB combination products in its recommended "level" or "parallel" configuration described by Corrin. 2 Tr. 173, 197-98.

DX 30 shows on its face a creation date of February 15, 2002. Moreover, at trial, Corrin testified that DX 30 "could have been [created] after the lawsuit, after January 2001." (2 Tr. 188). No evidence shows that, prior to DX 30's creation, Peterson's preferred method of assembly for G 4 and EMB products prior to was anything other than the parallel or level installation that Corrin testified about.¹⁴ No evidence shows that any of the 10 G 5 units sold with EMBs were assembled by Peterson after February 15, 2002 or that anyone exactly followed, DX 30 in assembling them.

Plaintiff's mistaken conclusion that DX 30 shows the assembled vertical configuration of the 10 G 5's which Peterson sold with EMB's forms the sole basis for its challenge to 45 Findings and part of the basis for its challenge to 4 others. Because that argument is fundamentally mistaken, each of these challenges (referencing Finding 26) fails.

¹⁴ In its appeal brief, plaintiff attacked DX 30 as "a Johnny-come-lately installation instruction sheet that Mr. Corrin ... had prepared after Blount filed suit, and then only for damage control." Plaintiff's Corrected Brief on Appeal at 41 (excerpt attached as Exhibit D). Plaintiff also argued that DX 30 had been correctly given little or no weight by this Court in its initial findings. *Id.* at 42. These statements are binding judicial admissions barring plaintiff from now claiming that DX 30 shows infringement, is the most crucial evidence of record and is entitled to great weight. *Soo Line R.R. Co. v. St. Louis Southwestern Ry. Co.*, 125 F.3d 481, 483 (7th Cir. 1997); *Medcom Holding Co. v. Baxter Travenol Labs., Inc.*, 106 F.3d 1388, 1404 (7th Cir. 1997) ("a 'deliberate clear and unequivocal' statement, either written or oral, made in the course of judicial proceedings" is a judicial admission). *See also Martinez*, 244 F.3d at 476 (5th Cir. 2001) ("a statement made by counsel ... may be considered a judicial admission").

Plaintiff also argues, again incorrectly, that Peterson's one "lab" or demonstration G 4-EMB unit must have been assembled in the technical configuration shown on DX 30 as opposed to Peterson's preferred "parallel" or "level" configuration testified to by Corrin. *See* Pltfs. App. at A-6-A-7, Findings 133-135, 138. No competent evidence, however, supports this inference.

Plaintiff relies solely on the Bortz deposition, PX 24. *See* Pltfs. App. at A-6, Finding 133. Bortz testified that representatives who visited Peterson's facilities "may" have been shown a working apparatus with a secondary burner. PX 24 at 68. At trial, Bortz testified that the few distributors who did come in saw a demonstration unit in Peterson's "lab." 2 Tr. 65-66. Bortz was never asked, however, in either his deposition or at trial, how this lab or demonstration unit was assembled by Peterson.

No affirmative evidence suggests that this demonstration unit was assembled according to the technical configuration shown in DX 30 and not to Peterson's non-infringing preferred "parallel" or "level" configuration testified to by Corrin. No evidence shows that this demonstration or lab unit was assembled on or after February 15, 2002 (after DX 30 was created). No evidence shows that the .06 inch height gap shown on DX 30 was present in any Peterson document or method in existence or use prior to February 15, 2002.

Plaintiff's arguments about DX 30 are merely a rehash of the claims it set forth in its Proposed Findings 62 and 63 (*citing* Corrin's testimony and DX 30 as evidence of infringement). No such reargument, however, can warrant any relief under Rule 52(b) and 59(e).

IV. THERE IS NO MANIFEST ERROR REGARDING PROOF OF INDIRECT INFRINGEMENT.

Plaintiff's admission that Finding 188 is "true" and its failure to oppose Uncontested Finding 190 necessarily dispose of plaintiff's contributory infringement claim. Pltfs. App. at A-12. Plaintiff's admission that the EMB can be installed level with or above the primary burner and thereby avoid infringement establishes, as a matter of law, that the EMB constitutes "a staple

article in commerce” because it has substantial non-infringing uses. See Uncontested Findings 14—16 (customer could install EMB level or above primary burner). Plaintiff’s statement that Finding 188 is “true,” freely made in a filed court document, constitutes a binding judicial admission, negating the contrary argument on pp. 5-6 of its brief. See *Martinez, supra*; *Soo Line, supra*; *Medcom, supra*.¹⁵

In addition, the record is also devoid of evidence that any third party ever installed a Peterson EMB secondary burner in an infringing manner. Before considering either contributory or induced infringement on remand, this Court must first conclude “that the ‘159 patent is infringed, either literally or under the doctrine of equivalents, by a customer of Peterson or other party using Peterson components.” *Golden Blount*, 365 F.3d at 1061. There simply is no such evidence in the record. Thus, no amended Finding could change the outcome.

Plaintiff argues that Corrin’s testimony and DX 30 prove customer infringement. Ignoring Blount’s admission and assuming reversal of Finding 109, it claims that DX 30 shows a technically infringing installation and that Corrin admitted that Peterson distributed that document to customers. Corrin, however, did not say what plaintiff claims:

Q. Was D 30 distributed to anyone *or drawings like D 30* distributed to any Peterson customer to your knowledge?

A. Yes, it has been.

Q. How was it provided to customers?

A. Well, when we ask the orientation of the two different burners, *we would provide a drawing like this*. Generally they’re satisfied with the installation and operating instructions that’s provided with the product.

¹⁵ That argument additionally fails because the burden to show *the absence* of non-infringing uses was always plaintiff’s. *Golden Blount*, 365 F.3d at 1061 (“Blount must show that Peterson’s components have no substantial non-infringing uses”). Peterson never had the burden to show non-infringing uses.

2 Tr. 183. (Emphasis added). Plaintiff's challenges to Findings 153-56 are based solely on this transcript passage.

When a question is asked "Did A or B occur?" an affirmative answer does not show that A occurred where the witness could have truthfully been referring to B occurring. Corrin was never asked whether he knew that DX 30 specifically was in fact sent to any customer. He was asked whether that exhibit *or drawings like it* had been sent. He testified that yes, "we would provide a drawing like this." Thus, Finding 154 is clearly correct, based on a careful and fair reading of the record and is not the result of any misrepresentation by Peterson. *See* Pltfs. App. at A-8, Finding 154.

Moreover, even if we assume for purposes of argument, that DX 30 shows infringement and was sent to some customers, it could make no difference to the judgment in Peterson's favor on the induced infringement claim. To prove induced infringement, "Blount must show that Peterson took actions which actually induced infringement." *Golden Blount*, 365 F.3d at 1061. In other words, plaintiff had to prove that the customers followed the drawing literally and achieved an infringing installation. There is no evidence of what any customer ever did with any installation. *See* Unopposed Finding 144.

Also, "Blount must show that Peterson knew or should have known that such actions would induce infringement." *Id.* Corrin's testimony that Peterson recommended a "parallel" or "level" installation and that he believed that a level or parallel installation is what DX 30 showed belies this willfulness element. 2 Tr. 173, 197-98. No evidence suggests that Peterson knew that a DX 30-type installation would infringe and proffered the document to customers anyway. Even Blount, when asked about DX 30, admitted that it did not show the primary burner being at a raised level from the secondary burner. Finding 109.

It was also plaintiff's burden to show the extent of infringement in order to obtain any damages. No evidence shows how many customers might have received DX 30. The record does reflect that DX 30, or a drawing like it, was only distributed upon request. 2 Tr. 183 (the customers were usually satisfied with the normal installation instructions). Proof of the scope of induced infringement was an essential element of plaintiff's case. The failure to introduce competent evidence supporting any essential element mandates judgment for Peterson on the induced infringement claim. *Celotex v. Catrett*, 477 U.S. 317, 322 (1986) (judgment warranted "against a party who fails to make a showing sufficient to establish the existence of an element essential to that party's case" where that party has the burden of proof). Here, plaintiff failed to introduce competent evidence of third party infringement, willfulness and extent of infringement.

Finally, plaintiff already argued in its own proposed findings that Corrin's testimony and DX 30 proved induced infringement. Pltfs. Prop. Findings 62 and 63. Its argument here is just an attempt to relitigate the same issues without any newly discovered evidence or even a new theory. Rule 52(b) and 59(e) simply do not permit that type of reconsideration.

V. THERE IS NO MANIFEST ERROR REGARDING THE DAMAGES FINDINGS.

Absent a reason to reverse the Findings that Peterson did not infringe, there is no reason for the Court to consider any proposed changes to the Findings regarding damages and Peterson's alleged willful infringement. Amending any of these Findings would not change the outcome of the case. *Lyons, supra*; *American Train Dispatchers, supra*. In the unlikely event that the Court need consider these issues, we attach our own appendix responding specifically to plaintiff's proposed amendments.

VI. THERE IS NO MANIFEST ERROR REGARDING THE EXCEPTIONAL CASE FINDINGS.

The record clearly shows that plaintiff was aware during discovery both that Peterson did not directly infringe and that plaintiff needed proof that some third party had infringed using

Peterson's components in order to prove its indirect infringement claims. The sole infringement evidence which plaintiff cites seeking amended Findings (DX 30) was not even created until February 15, 2002, four months after discovery closed.

At the close of discovery, plaintiff had no evidence whatsoever about how Peterson had assembled the G 5 units or suggesting infringement by anyone. At the close of discovery, plaintiff had no evidence that Peterson or anyone else had ever assembled G 4 and EMB products in an infringing configuration. Plaintiff's counsel admitted on October 5, 2001, that it did not really want to take customer discovery. By waiting until the last minute, plaintiff had rendered such discovery practically infeasible, in any event.

Yet, plaintiff continued to press its case. It went to trial with no evidence suggesting infringement by anyone and offered none. It laid no foundation for any of its demonstrative exhibits. It offered no expert testimony.

Plaintiff's sole argument about customer infringement was that, because the EMB's were suitable only for infringing uses, any customer use must be an infringing use. Plaintiff has now belatedly admitted the fallacy of that argument by conceding that installation of an EMB level with or above the primary burner does not infringe and that customers could well make such installations. See Finding 188, Uncontested Findings 14—16 and 190. Plaintiff offers no explanation why it could not have come to this conclusion—and disclosed it—much earlier.

This record is more than sufficient to establish plaintiff's bad faith for purposes of 35 U.S.C., § 285:

Where, as here, the patentee is manifestly unreasonable in assessing infringement, while continuing to assert infringement in court, an inference is proper of bad faith, whether grounded in or denominated wrongful intent, recklessness, or gross negligence. The alternative, abuse of the courts through manifestly unreasonable lawsuits based on uninvestigated allegations, would constitute a blot on the escutcheon of the law and a violation of Rule 11, Fed.R.Civ.P.

Eltech Systems Corp. v. PPG Industries, Inc. 903 F.2d 805, 811 (Fed.Cir. 1990). *Accord*, *Badalamenti v. Dunham's, Inc.*, 896 F.2d 1359, 1364 (Fed.Cir. 1990) (case is exceptional if the conduct of the losing party would make it grossly unjust for the prevailing party to be left with the burden of litigation expenses); *Porter v. Farmer's Supply Service, Inc.*, 790 F.2d 882, 887 (Fed. Cir. 1986) (arguments not based on "sound common sense and an intelligent judgment" warranted fees award);¹⁶ *Algren Watch Findings, Inc.*, 197 F.2d 69, 72 (2nd Cir. 1952) ("The deficiency of the proof which plaintiff offered at the trial could well have been taken as an indication of bad faith ...").

Proof of plaintiff's subjective wrongful intent is not a required element of a § 285 finding. *Eltech Systems*, 903 F.2d at 810 ("knew or should have known" was sufficient). The sole authority cited by plaintiff on this subject holds that bad faith may be shown by gross negligence. *Advance Transfer Co. v. Levinson*, 837 F.2d 1081, 1085 (Fed.Cir. 1988). Subjective bad faith is also not the standard for Rule 11 sanctions. *Ted Lapidus S.A. v. Vann*, 112 F.3d 91, 96 (2nd Cir. 1997) (liability may be imposed if the lawyer's claim to have evidentiary support is not objectively reasonable); *Local 285 v. Nonotuck Resource Assocs.*, 64 F.3d 735, 737 (1st Cir. 1995) ("subjective bad faith" not necessary). *Eltech Systems* confirms that a fact pattern establishing a Rule 11 violation is also more than sufficient to warrant an award under § 285. 903 F.2d at 811.

Plaintiff was required to investigate before filing and evaluate continually throughout the proceeding whether it could prove infringement against Peterson. *Retired Chicago Police Assn. v. Firemen's Annuity and Benefit Fund of Chicago*, 145 F.3d 929, 934 (7th Cir. 1998) (pre-filing duty to investigate under Rule 11); *Loctite Corp. v. Fel-Pro, Inc.*, 667 F.2d 577, 584 (7th Cir.

¹⁶ Plaintiff's demonstrative exhibit waiver argument, refuted by its own Proposed Jury Instruction No. 19, clearly satisfies this bad faith test.

1981) (exceptional case under § 285 when patentee initiated suit with unconfirmed data to support infringement). This plaintiff had no confirmed evidence of Peterson's infringement when it filed suit and it never found any through discovery. In fact, it never took discovery that might have answered the question directly. (Plaintiff took no discovery focused on how Peterson assembled the G 5's with EMB's or from Peterson dealers known or available to it about customer installations). Its continuation of the suit without any competent evidence particularly of customer infringement constitutes bad faith under § 285 and warrants attorney's fees.

That plaintiff may be the owner of a valid patent that Peterson has not infringed or that plaintiff prevailed on claim construction does not make this litigation any less vexatious where there never was any competent proof of Peterson's infringement under any construction of the claims. That plaintiff did not engage in inequitable conduct before the patent office only shows that it did not engage in one possible form of bad faith conduct; it does not insulate plaintiff's bad faith trial of a case it knew or should have known it could never prove. There was no manifest error in awarding Peterson fees under 35 U.S.C. § 285.

CONCLUSION

For the above stated reasons, plaintiff's Motion to Amend Findings and Conclusions and its Motion For Reconsideration must be denied.

Respectfully submitted,

Jerry R. Selinger

State Bar No. 18008250

JENKENS & GILCHRIST, A P.C.

1445 Ross Avenue, Suite 3200

Dallas, Texas 75202

214/855-4776 (Telephone)

214/855-4300 (Facsimile)

COUNSEL FOR DEFENDANT

ROBERT H. PETERSON CO.

OF COUNSEL:

Leland W. Hutchinson, Jr.

Jennifer L. Fitzgerald

David S. Becker

FREEBORN & PETERS, LLP

311 S. Wacker Dr., Suite 3000

Chicago, Illinois 60606

312/360-6000 (Telephone)

312/360-6572 (Facsimile)

#622232 v.1

CERTIFICATE OF SERVICE

This certifies that a copy of the foregoing document was served by first-class mail, postage prepaid, to counsel for Plaintiff, William D. Harris, Jr., Schultz & Associates, P.C., 5400 LBJ Freeway, One Lincoln Center, Suite 525, Dallas, Texas 75240. and Charles Gaines, Hitt Gaines, P.C., 2435 North Central Plaza, Suite 1300, Richardson, Texas 75080, this 23rd day of July, 2004.

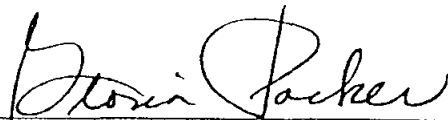

expected, particularly given the fact that the Defendant's valve rests on the fireplace floor to self-align the device in an infringing configuration. (JA--1268; JA--1549-50). Regardless of whether the assembly was botched, Blount was damaged because of the lost opportunity to make the sale. *Stryker Corp. v. Intermedics Orthopedics, Inc.*, 96 F.3d 1409, 1417 U.S.P.Q.2d 1065 (Fed. Cir. 1996). In view of the infringing device's simple design, as well as other evidence, the district court did not err in its finding.

The Defendant implicitly argues that Blount must prove each and every act of infringement with direct evidence. However, this is contrary to established case law. As mentioned above with respect to direct infringement, the law is settled that circumstantial evidence may be used to establish proof of induced infringement. See *Moleculon, supra*.

In contrast to the position the Defendant argues, the record is replete with circumstantial evidence that the consumer ultimately assembles (either himself or by a professional installer) the EMB with a G4 or G5 burner in an infringing manner. The Defendant offered no testimony to establish that the ultimate consumer did not assemble the EMB with the G4 or G5 burner in an infringing manner, except for a Johnny-come-lately installation instruction sheet that Mr. Corrin, one of the Defendant's officers, prepared after Blount had brought the suit, and then only for

damage control. (JA-2229). The district court judge admitted the Defendant's tardy installation instructions, accorded them their appropriate weight, and apparently found them wanting.

The Defendant has altogether failed to establish that the district court's finding regarding induced infringement and contributory infringement was clearly erroneous. Therefore, this Court should not overturn the district court's finding.

V. Damages

To recover lost profit damages, the patentee need only show causation and the factual basis for causation between the infringement and the lost profits. *Lam, Inc. v. Johns-Manville Corp.*, 718 F.2d 1056, 1065, 219 U.S.P.Q. 670 (Fed. Cir. 1983). To do this, *Panduit* established that the patent owner need only demonstrate:

- 1) a demand for the product during the period in question;
- 2) an absence, during that period, of acceptable non-infringing substitutes;
- 3) its own manufacturing and marketing capability to meet or exploit that demand; and
- 4) a detailed computation of the amount of the profit it would have made.

WOOD, PHILLIPS, VANSANTEN, CLARK & MORTIMER
FOUNDED IN 1876
ATTORNEYS AT LAW
SUITE 3800
500 WEST MADISON STREET
CHICAGO, ILLINOIS 60661-2511

RICHARD S. PHILLIPS
WILLIAM A. VANSANTEN
JEFFREY L. CLARK
JOHN S. MORTIMER
F. WILLIAM McLAUGHLIN
DEAN A. MONCO
JEFFERY N. FAIRCHILD

OF COUNSEL
ROBERT V. JAMBOR
L. DANIEL HO

HAROLD A. WILLIAMSON

TECHNICAL SPECIALIST
CHRISTOPHER D. WOOD, PH.D.
HUI ZHANG, PH.D.

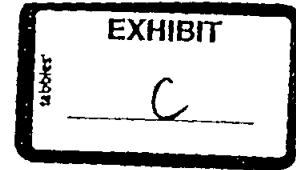

TELEPHONE
(312) 876-1800
TELECOMER
(312) 876-2020
E-MAIL
info@woodphillas.com
RETIRED
JAMES C. WOOD

October 30, 2001

William D. Harris, Jr., Esq.
Hitt Gaines & Boisbrun, P.C.
P.O. Box 832570
Richardson, Texas 75083

Re: Golden Blount, Inc. v. Robert H. Peterson Co.
Our Ref.: 742.00008

Dear Bill:

As further evidence of common use of dual burner, dual valve burner systems prior to the Blount patent, enclosed are a Declaration of John Palaski and a Declaration of Darryl R. Dworkin. We ask that you share this information with your client. In connection therewith, Mr. Bortz would like to speak directly with Mr. Blount. Please advise us of Mr. Blount's availability.

In partial response to questions you raised during the deposition of Mr. Bortz, on the list of ember booster sales, the term "detail count" refers to the number of line items on a particular invoice that were shipped on the same day as any ember booster devices. Under separate cover, I am forwarding you a G-4 unit which includes the support pan and burner tube.

Sincerely,

A handwritten signature in cursive script, appearing to read "F. William McLaughlin".

F. William McLaughlin

FWM:swk

Enclosures

cc: Leslie Bortz (w/ encls)

100 YEARS
1876-2001

JT-APP 2862

STIPULATIONS BETWEEN PLAINTIFF GOLDEN BLOUNT, INC.
AND DEFENDANT, ROBERT H. PETERSON CO.

1. It is stipulated between the parties set forth above that the end users of Robert H. Peterson Co.'s Ember Flame Booster will use the Ember Flame Booster in a fireplace with a primary burner tube and a support pan at least equivalent to, if not identical to, Robert H. Peterson's G-4 series pan and primary burner tube assembly and that such end user would also connect the Ember Flame Booster and the primary burner tube to a main gas source having a main valve associated therewith. The in place assembly is used with artificial logs and embers to replicate a real wood burning fire in the fireplace.

2. It is stipulated between the parties set forth above that the end users of Robert H. Peterson Co.'s pre-assembled G-5 series, which includes the Ember Flame Booster with a primary burner tube and pan, use the Ember Flame Booster with the primary burner tube and the support pan in a fireplace and that such end user would also connect the pre-assembled G-5 series to a main gas source having a main valve associated therewith. The in place assembly is used with artificial logs and embers to replicate a real wood burning fire in the fireplace.

APPENDIX

Response in Support of Findings 211, 313, 314, 315, 316, 317, 320, 321, 322, 323 and 324: Plaintiff claims that Finding 26 is incorrect because Tod Corrin's testimony and DX 30 provides a basis for reconsidering these Findings. For the reasons stated in our Opposition, that argument necessarily fails.

Response in Support of Finding 214: The record does not establish a "two-supplier market." Rather, Uncontested Finding 218 establishes that a Peterson customer with a "G 4" burner could not even consider purchasing plaintiff's product to install on its "G 4" burner. Conclusions 94, 95 and 96 establish plaintiff can recover no damages unless it can demonstrate that, but for infringement, it would have made defendant's sales. Plaintiff here not only failed to establish any form of infringement, but even if infringement were proven, plaintiff failed to prove that it could have made a single additional sale in the absence of Peterson's EMB sales.

Response in Support of Finding 215: Corrin did not testify in the manner plaintiff suggests. Corrin merely said "Yes" in response to defendant's counsel's characterization of Corrin's prior testimony. 2 Tr. 196. What Corrin actually testified was "[m]any of the dealers actually sold [the EMB] to people who had previously purchased the G 4 burner systems and had those installed. It was a way to get the consumer to come back into their store to buy more products." 2 Tr. 176 (emphasis added). The trier of fact was free to believe this answer. No manifest error occurred requiring amendment.

Response in Support of Findings 223 and 224: The record does not establish, nor does the plaintiff provide any citation for its assertion. No evidence establishes the number of EMB's that were sold with an associated burner assembly and log set. The record only establishes that 97% of plaintiff's sales were of an ember burner along with an associated burner assembly and

log set. 1 Tr. 160-61. Furthermore, as discussed in support of Finding 214, Uncontested Finding 218 establishes that a Peterson customer with a "G 4" burner could not even consider purchasing plaintiff's product to install on its "G 4" burner. Conclusions 94, 95 and 96 establish plaintiff can recover no damages unless it can demonstrate that, but for infringement, it would have made defendant's sales. Plaintiff erroneously refers to this same claim in its challenge to Finding 224. This claim cannot change that Finding for the same reasons.

Response in Support of Findings 225 and 226: Hanft was not offered as an expert nor did he claim personal knowledge of Peterson's sales. Hanft testified about "CEBB's" (plaintiff's product) not "EMB's (Peterson's). 1 Tr. 160. See Uncontested Findings 112 - 123. Plaintiff also erroneously refers to this same claim in its challenge to Finding 226.

Response in Support of Findings 233, 234, 235, 237, 239 and 240: Plaintiff's first sentence admits Finding 233 (that he did not prepare PX 18). He did not testify that he had personal knowledge sufficient to authenticate it. Plaintiff simply relies on those admissions in a failed attempt to refute statements 234, 235, 237, 239 and 240.

Response in Support of Finding 242, 243 and 244: Plaintiff does not cite any evidence establishing that the information contained in DX 3 at 000219-230 does not relate to valid sales costs that plaintiff continues to incur. Regardless of the time frame, however, plaintiff failed to produce relevant cost data discharging its burden of proving its margin.

Response in Support of Findings 245, 248, 250, 256 and 257: Plaintiff failed to establish that any of the products mentioned in testimony were not non-infringing substitutes. The record merely establishes that as many as six other devices exist on the market. While the record does indicate that plaintiff sent letters to the makers of those products, there is no evidence in the record establishing those products infringed plaintiff's patent in any respect.

Responses in Support of Findings 272, 273 and 277: Because Corrin is not a patent attorney, his cover letter does not change the fact that neither Bortz nor McLaughlin believed the December 16, 1999 letter to be a charge of infringement. McLaughlin testified that the December 16, 1999 letter was “[c]arefully crafted to not be an infringement charge and that [it was] the type of letter an attorney will frequently draft to avoid the other side going ahead and filing a declaratory judgment action.” Uncontested Finding 271; (1 Tr. 199).

Response in Support of Findings 283, 284, 285, 286, 290, 291, 292, 293, 294, 295, 300, 307, 309 and 311: While McLaughlin did not tell Peterson until after suit was filed that a file history and cited references would need to be ordered and a prior art search would have to be done, there is no basis in the record for the remainder of Plaintiff’s claim. In fact, the record reflects that there was “(No response.)” by Mr. Bortz to plaintiff’s counsel’s questions regarding his motivation for assembling these materials. 2 Tr. 62. Moreover, Peterson was constantly in contact with its lawyers, seeking advice and counsel about the possibility of infringement. Uncontested Finding 265, 274, 275 and 279. Peterson discussed with its attorney the fact that Peterson had been producing products that did what the ‘159 patent claimed for 25 years. Moreover, Peterson requested from plaintiff, but never received, a more thorough explanation of Plaintiff’s claims. See DX 22; DX 23, DX 33; DX 34; DX 35; DX 43; DX 44; DX 45; DX 46. All of these actions show that Peterson sought to understand and avoid any possibility of infringement. Far from willful infringement, Peterson followed legal advice in good faith.

Response in Support of Findings 303 and 304: DX 30 merely shows that the fireplace floor limits how low the EMB can be installed. 2 Tr. 198-201. In the lowest possible position, that exhibit shows that the top of the EMB secondary burner could be no more than 0.06 inches below the top of the G4 primary burner. Six one hundredths of an inch, however, is an extremely

tight clearance. Any Peterson customer who installed the EMB even 1/16th of an inch (.0625") higher than the lowest possible position – to obtain clearance to turn the valve with one's fingers for instance – would make a non-infringing installation. Finding 188; Uncontested Finding 190. In all probability, most, if not all, of Peterson's customers did not opt for the lowest possible installation position. In fact when asked, Corrin testified that "[y]ou would want both burners to be parallel." 2 Tr. 197-98. Plaintiff offered no evidence of even a single instance in which any customer or installer assembled a G 4 and an EMB in an infringing manner.

Response in Support of Findings 312 and 318: Plaintiff erroneously assumes that the Court's Findings have already been overturned. As Peterson has explained, the record establishes that Plaintiff failed to produce any evidence of infringement by anyone. Moreover, throughout the course of litigation, Peterson had a good faith belief that it was not infringing the '159 patent. Additionally, Peterson refers to its responses to Plaintiff's claims regarding Findings 211 and 283. Plaintiff also erroneously refers to this same claim in its challenge to Findings 318. This claim cannot change that Finding for the same reasons.

#622584

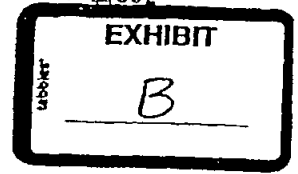

HITT GAINES & BOISBRUN, P.C.
INTELLECTUAL PROPERTY LAW & RELATED MATTERS

Of Counsel
William D. Harris, Jr.

email: bharris@abstractassets.com

January 31, 2002

VIA FACSIMILE 312-876-2020
F. William McLaughlin
500 West Madison Street
Suite 3800
Chicago, IL 60661-2511

Re: Golden Blount v. Peterson

Dear Bill:

I enclose a proposed stipulation covering the situation related to the requirement for an "actual infringer". You will recall that we agreed we were going to work something out to cover that situation by stipulation. I suggest that the enclosed proposed stipulation may be satisfactory for this purpose. Please let me hear from you on this matter.

We are working on a proposed pretrial order. Under the present circumstances, I am going to be pressed to have even a rough draft ready to send to you on Friday (tomorrow), but if I miss tomorrow I would expect to fax a draft of it to you on Monday. Of course, if we finish on Friday we will fax it to you then. By the way, I would appreciate it in the future if we could use the fax liberally with one another and on filing or service items, concurrently send a hard copy.

Best regards.

Sincerely,

William D. Harris, Jr.

WDH: ecr
Enclosures

cc: Jerry Selinger (by fax)

IN THE UNITED STATES DISTRICT COURT
FOR THE NORTHERN DISTRICT OF TEXAS
DALLAS DIVISION

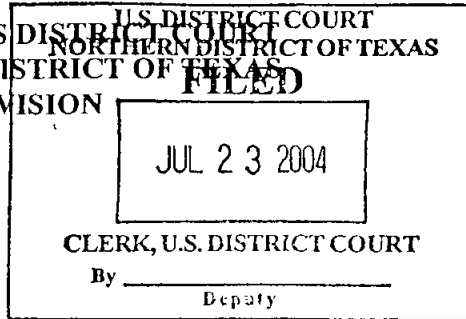

GORDON BLOUNT, INC.,

Plaintiff,

v.

ROBERT H. PETERSON CO.,

Defendant.

§
§
§
§
§
§
§
§
§
§

CA 3:01-CV-127-R

ORDER

The hearing on PLAINTIFF'S MOTION TO AMEND ITS FINDINGS OF FACT AND CONCLUSIONS OF LAW, set for Wednesday, August 4, 2004, at 10:00 a.m., is RESCHEDULED for Wednesday, August 18, 2004, at 10:00 a.m.

IT IS SO ORDERED.

ENTERED: June 23, 2004.

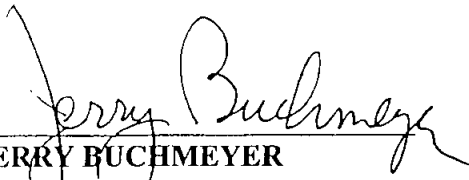
JERRY BUCHMEYER
SENIOR UNITED STATES DISTRICT JUDGE
NORTHERN DISTRICT OF TEXAS

IN THE UNITED STATES DISTRICT COURT
FOR THE NORTHERN DISTRICT OF TEXAS
DALLAS DIVISION

GOLDEN BLOUNT, INC.,

Plaintiff,

v.

ROBERT H. PETERSON CO.,

Defendant.

§
§
§
§
§
§
§
§
§

Civil Action No.
By
3-01CV0127-R

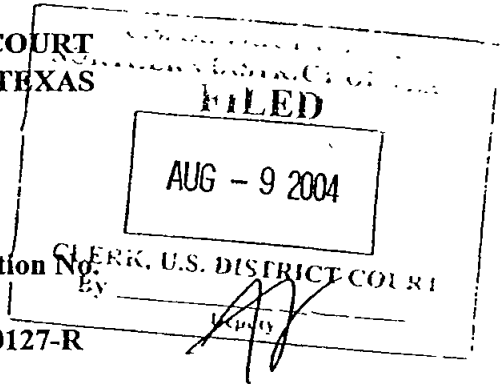

**PLAINTIFF, GOLDEN BLOUNT, INC.'S
REPLY TO DEFENDANT'S OPPOSITION TO AMEND
FINDINGS, FOR RECONSIDERATION AND FOR A NEW TRIAL**

Introduction

It is indeed unfortunate how ordinary facts can become so obscured and convoluted given the passage of time and the significant amount of verbal dust thrown into the air. The Defendant has now so obscured the record that it may be nearly impossible to ever reconstruct a sane and reasonable version as to what the facts truly are. Plaintiff must, however, attempt to do so.¹ The clearest understanding of the facts no doubt occurred soon after trial when the Court ruled in Plaintiff's favor. Since that time, however, the Defendant has seized the opportunity afforded by a simple remand by the Federal Circuit² and has managed, through half-truths and out-right misstatements, to transmute a sound and just decision into one founded only on supposition, one that

¹It is impossible for Plaintiff to, within the confines of 10 pages, address each and every misstatement expressed in Defendant's Opposition to Plaintiff's Motion to Amend Findings For Reconsideration And For A New Trial (hereinafter, Opposition). Moreover, given the Defendant's penchant for accusing Plaintiff of having admitted to every thing to which it did not specifically object to in the Defendant's Findings of Fact and Conclusions of Law that were provided to and adopted by this Court, Plaintiff does, for the record, object to Defendant's Opposition in its entirety due to numerous misstatements of fact and does not specifically admit to anything stated therein.

²Contrary to what the Defendant stated in its opening sentence of its Opposition, the Federal Circuit did not instruct this Court to make "new findings," and it never said that this Court's findings were wrong, it only instructed this Court to make specific factual findings because this Court didn't provide the Federal Circuit with findings of fact sufficient to support a conclusion of infringement. Importantly, the Federal Circuit never questioned the sufficiency of the evidence, but in fact affirmed this Court's claim construction in its entirety and its finding that the patent was not invalid.

dismisses the weight of evidence on the record and points only to the absence of evidence to substantiate its findings.

Argument

Due to the amount of confusion that now understandably surrounds this case, the Plaintiff believes that it would be helpful to provide this Court a brief synopsis of what actually transpired at trial. Initially, Plaintiff brought its case of infringement against Defendant after Defendant refused to cease its infringing activities for almost a one and one-half year time period after being informed of the '159 Patent. Because there was no Markman hearing prior to trial, each party asserted the claim interpretation or alternative claim interpretation that it thought most reasonable during the course of trial. A significant part of the Plaintiff's case was to urge the Court to adopt the "tops test" or "centerline test". On the other hand, a significant part of the Defendant's case was to urge the Court to adopt the "bottoms test".³ The Court received evidence in the form of exhibits and testimony and concluded at the end of trial that Defendant willfully infringed the '159 Patent and also found the case to be exceptional and awarded Plaintiff its attorney's fees. Defendant appealed and the Federal Circuit remanded for the reasons mentioned above.

Reasons for a New Trial

At this Court's request, after the remand by the Federal Circuit, both Plaintiff and Defendant submitted proposed findings of fact and conclusions of law. Within a matter of weeks of submitting the documents, this Court adopted Defendant's findings. The Plaintiff now requests that the Court reconsider its adoption of those findings because they are erroneous and contain manifest errors of law and fact.⁴ In requesting reconsideration, Plaintiff is not asking the Court to relitigate anything, as Defendant alleges. On the contrary, as discussed below, the Court has all the evidence it needs to support the Plaintiff's findings and conclusions.

³See Defendant's Proposed Findings of Fact and Conclusions of law (Nos. 31 & 32) submitted on or about April 19, 2002, as well as Defendant's initial Appeal Brief submitted to the U.S. Court of Appeals for the Federal Circuit (pgs. 12-16 and 37-38) filed on or about May 19, 2003. Moreover, Defendant's case-in-chief was directed to establishing this point and presented no evidence rebutting Plaintiff's case-in-chief.

⁴Defendant asserts that Plaintiff did not argue new facts or claim any manifest error. Perhaps Defendant failed to carefully read Plaintiff's Request. The Request, which was made generally under the Federal Rules of Civil Procedure, specifically claimed that the adopted findings contained manifest errors, and the findings of facts urged by the Plaintiff are totally opposite from those urged by Defendant. This is a sufficient basis to request, move, or whatever verb one wishes to use, the Court to reconsider its adoption of Defendant's erroneous findings.

Only in the event that the Court chooses to affirm its adoption of Defendant's Findings, does Plaintiff request a new trial. This Court's adoption of the Defendant's Finding of unjustified and vexatious litigation on the part of the Plaintiff, and the attorneys' fees levied against the Plaintiff in view of the supposed unjustified and vexatious litigation, is enough in and of itself to grant a New Trial. A New Trial is proper when there is an absolute absence of evidence to support the verdict. *Booth v. Holmes*, 399 F.2d 495 (5th Cir. Miss 1968). Not one shred of evidence exists on the record that supports the verdict that the Plaintiff was involved in unjustified and vexatious litigation. To fully support the finding that Plaintiff was involved in unjustified and vexatious litigation, this Court would be required to grant a New Trial, such that this issue as well as other issues could be fully litigated.

In addition to there being no evidence regarding the unjustified and vexatious litigation on the part of the Plaintiff on the record, new evidence has just been uncovered that is pertinent to infringement.⁵ In reviewing Defendant's Attorneys' Fees submitted to this Court on July 22, 2004, it has come to the Plaintiff's attention, for the first time, that the Defendant failed to fully and accurately respond to Plaintiff's document request during discovery of providing "all documents and things concerning United States patent 5,988,159 ("the '159 patent')". The Defendant's time entries, entered merely a few days after trial, refer to a G44 burner, and ensuing opinion related to the G44 burner, which constitutes new evidence. Neither the G44 burner nor the ensuing opinion were ever brought to the attention of the Plaintiff, which flies in the face of the document request previously mentioned. The Defendant obviously believed the G 44 burner to relate to the '159 patent, or it would not have obtained an opinion of counsel with respect to it. Additionally, even if the Defendant were unaware of the G44 at the time of responding to the document request, FRCP 26(e) requires that all parties supplement disclosures when required. Thus, a New Trial is warranted for this reason also.

Additionally, new evidence has been uncovered as to the investigation and discussion of a malpractice claim by the Defendant against the firm Wood, Phillips, *et al.*, and F. William McLaughlin, who originally issued the oral opinion upon which this Court based its first willfulness finding. This new evidence, at the very least, is telling as to the mind set of the Defendant with regard to the thoroughness and reliability of the oral opinion

⁵In non-jury trials, courts have recognized three grounds for a new trial: (1) manifest error of law, (2) manifest error of fact, and (3) newly discovered evidence. *Brown v. Wright*, 588 F.2d 708, 710 (9th Cir. 1978).

upon which it based its entire non-willful infringement argument. Thus, this new evidence may also be added to the reasons for this Court granting a New Trial.

In the event a New Trial is granted, a number of issues may be revisited, including discovery as to direct evidence how Defendant's customers installed the infringing device. As Defendant seeks to renege on its prior agreement with Plaintiff that the accused device would alleviate the need to discover Defendant's customers, the New Trial would allow Plaintiff to appropriately address this issue.

Evidence of Direct Infringement

Contrary to what the Defendant's erroneous "Findings" state and Defendant now argues, Plaintiff established its case of infringement against Defendant. To begin with, during trial, Plaintiff established the presence of each element in Defendant's accused device, Plaintiff's Exhibit 4A (P 4A),⁶ through the testimony of Golden Blount. Mr. Blount testified to the presence of all the elements of independent claims 1 and 17 in P 4A, both literally and under the doctrine of equivalents. In establishing this, Mr. Blount went through each item of Plaintiff's Exhibit 9 (P 9)⁷, which is a literal infringement chart, during his testimony. Mr. Blount's testimony at the time of trial was never controverted on the issue of infringement with respect to the "tops test." In fact, the only way in which the Defendant has attacked Plaintiff's infringement case, up until now,⁸ has been

⁶Defendant challenges the authenticity of its own device. In accordance with an agreement between counsel (See Deposition of Leslie Bortz, Vol. 1, pages 167-168), one of Defendant's G-4 and an ember burner were obtained by Plaintiff and collectively identified at trial as 4A. Defendant's "Findings" state that no foundation was laid by Mr. Jankowski. So, that no further confusion is generated by this issue, Mr. Jankowski's unequivocal trial testimony at Tr. vol. 2, pg. 145, follows:

A. This is Peterson.

Q. This is what?

A. This is Peterson's product.

Q. How do you know?

.....

Q. How do you know that 4 A is Peterson?

A. I know the component parts. I've seen them.

Foundation does not get any more certain than this.

⁷Defendant's "Findings," as now argued, states that Plaintiff's Exhibit P 9 was not probative. But, even if the exhibit itself was not probative, Mr. Blount used it as a guide during his testimony of establishing the presence of each and every element of the claims in Defendant's accused device, and his detailed testimony using this exhibit alone is sufficient to establish the presence of each claimed element in the accused device (P 4A).

⁸Of course, the Federal Circuit affirmed the tops tests as found by this Court and as urged by Plaintiff at trial, and now that the claim construction is settled, the Defendant has, for the first time, begun whistling a different tune to the effect that Plaintiff never really established any kind of infringement whatsoever, regardless of the claim construction!

to argue that there was no infringement because either the bottom of the primary burner tube of its device was not at a raised level with respect to the bottom of the ember burner tube, as is so accurately illustrated in Defendant's Exhibit 30 (D 30), or alternatively the bottoms of the tubes were level with respect to each other.

What Defendant did not anticipate, however, was that both this Court and the Federal Circuit would adopt the "tops test." With the claim construction now ruled upon by this Court and the Federal Circuit, the Defendant tries to avoid the consequences of its own exhibit and attempts to misdirect the Court by arguing that D 30 does not establish direct infringement by anyone. Defendant's own D 30, a copy of which is attached as Exhibit A, belies this because it clearly illustrates that the top of the primary burner tube is above the top of the ember burner tube. In fact, in its Opposition, Defendant even admits this.⁹ Unmistakably, Defendant now desperately argues that D 30 was not routinely distributed to anyone. Defendant further contorts Mr. Corrin's testimony by arguing that when Mr. Monco, Defendant's counsel, asked Mr. Corrin whether D 30 "*or drawings like*" D 30 had been distributed, Mr. Corrin's one word answer of "Yes" was insufficient for this Court to determine whether he meant he was sending D 30 "*or drawings like*" D 30 (i.e., Defendant's A or B argument). This amusing argument sadly lacks any hint of veracity, in view of the complete record, which speaks volumes in and of itself. However, to shed a little more light on the situation, the Plaintiff respectfully directs the Court's attention to the second volume of the trial transcript, pages 173-74 where the colloquy between Mr. Monco and Mr. Corrin is quite telling and where no such alternative construction can be conveniently implied:

Q. What is being shown on Exhibit D 30?

A. It's the relationship of the ember booster which is also called the secondary burner to the primary burner that's in the glowing ember burner G 4.

Q. Would you more precisely show what's actually being shown in the drawing here?

A. It shows that the ember booster is generally level to the main burner tube.

Q. Okay. And then I would ask you then, please, to continue with your explanation of what's shown on the drawing.

A. So it shows the ember booster tube normally would be installed just slightly below the top of the main burner tube and would be about a quarter of an inch above the bottom of the main burner tube.

This is not consistent with what Defendant argued in the past. Previously, Defendant argued there was no infringement because its primary burner tube was not at a raised level with respect to the ember burner tube in view of Defendant's urged claim construction, and the ports of the ember burner tube were not directed away from the fireplace opening. (See citations in Footnote 2), both of which failed to obtain the Federal Circuit's affirmation.

⁹In fn.3, page 5, of Defendant's Opposition, it states in pertinent part: "In the lowest possible position, that exhibit [D 30] shows that the top of the EMB secondary burner could be no more than 0.06 inches below the top of the G 4 primary burner."

- Q. Okay. And what's the basis for your statement that this is -- this is how the ember flame booster would be installed?
- A. Anytime a dealer or distributor would ask for a way to install the ember booster, this along with the instructions would be provided to them. So this is a drawing giving them the dimensions so they would know how to do that based on our recommendation.
- Q. And if they go straight down on both, then what is the relative position of the gas jets on the main burner representative to the --
- A. The main burner gas jets would be below the ember burner gas jets.

This concise colloquy, along with Mr. Corrin's other testimony that D 30 was in fact given to its customers, not only evidences Defendant's urged claim construction at the time (i.e., the "bottoms test"), but also serves to establish that Defendant intentionally distributed instructions to its clients that guided them to assemble the component parts in what ultimately was an infringing configuration. D 30 so specifically described the configuration that all customers who obtained it necessarily infringed by their assembly. To the extent that circumstantial evidence is present here, it is very strong and virtually irrefutable. Moreover, this not only serves as a basis to establish direct infringement, as explained below, but also as a basis for contributory infringement and induced infringement on the part of the Defendant. This is but one example of some of the evidence that, according to the Defendant, does not exist.

Incredibly, Defendant spends almost a page of its Opposition attacking its own exhibit D30 by arguing how Mr. Blount "flipped-flopped" on his testimony during trial where he inadvertently stated that D 30 did not show the primary burner tube at a raised level with respect to the ember burner tube because he misunderstood the question that was asked. The Defendant then asserts that this misunderstanding constitutes an "admission" on the part of Plaintiff. This is another misdirected argument on the part of Defendant. Defendant tries to take Mr. Blount's momentary confusion and turn it into an "admission." To swallow this red herring, the Court would have to forget the fact that Mr. Blount, shortly thereafter when the question was re-stated, corrected himself and testified that the primary tube was higher than the ember burner tube. (Tr. vol. 3, pg. 37). Furthermore, for arguments sake, even if Mr. Blount had never corrected himself, his testimony would fly in the face of D 30¹⁰ itself, because D 30 shows that the top of the primary burner tube is higher than the top of the ember burner tube, as Defendant has now admitted. (See fn. 9, *supra*).

¹⁰Defendant also argues that Plaintiff is estopped from relying on D 30 because during trial and in its appeal brief, Plaintiff questioned its timeliness and real purpose. This is irrelevant, however, in view of the fact that it is an exhibit accepted by the Court and as part of the record has been given its appropriate weight. Moreover, it is, in fact, an inescapable admission on the part of Defendant, much to its chagrin.

Contrary to Defendant's "Findings" that no direct infringement by Defendant itself was proven, the Court's attention is directed to volume 1, pages 68-70, of Leslie Bortz' deposition, where Mr. Bortz testified that manufacturer's representatives (e.g., distributors) were shown a functioning EMB device in Defendant's showroom. Given Defendant's own assembly instructions, particularly those set forth in D 30, which were given to its customers, (Tr., vol. 2, pg. 183), one is compelled to conclude that the device was assembled in accordance with those installation instructions. This is particularly the case where, as noted above, Mr. Corrin testified that D 30 was the way Defendant recommended the device should be set up. Why would Defendant set up its device differently than it recommended to its customers? The short answer is, they wouldn't. This is strong and compelling circumstantial evidence that cuts against Defendant's erroneous findings. Similarly, direct infringement on the part of Defendant's customers is also established through this same exhibit. Since the exhibit was given to its customers as Mr. Corrin states, it is logical to conclude that they did install the device in the manner suggested by the manufacturer.

In addition to D 30, additional evidence introduced at trial exists that indicates how Defendant and its customers directly infringed the '159 Patent. Page 3 of Defendant's general installation instructions included within the box of all ember burners sold, which was introduced at trial as Defendant's Exhibit D-34 (D-34), states in pertinent part: "Tighten securely so the Ember Flame Booster valve faces forward and flush with the burner pan." The only conceivable way that the valve can be "flush" with the burner pan and be configured in the way testified by Mr. Corrin is for both of them to be resting on the hearth floor. Mr. Corrin's testimony confirms this. (Tr., vol. 2, p 200 and 202). While D 30 does not show the valve, it does show the orientation spoken of by Mr. Corrin, and in such a configuration, the top of the primary burner tube is above the top of the ember burner tube. Again, the circumstantial evidence strongly supports the fact that even the general instructions provided in the box of every ember burner would result in an infringing configuration whether the instructions were applied to either Defendant's G-4 or G-5 device.¹¹

Evidence of Indirect Infringement

¹¹Defendant attempts to separate application of the facts established with respect to G-4 from the G-5 device. This is not a credible position because Mr. Corrin testified that the G-5 is the same as the G-4 except that the G-5 has all the gas connections and valves preassembled by Defendant at the factory and has an ANSI standard approval by CSA on the G-5 burner. (Tr., vol. 2, pg 179). Thus, it would be logical to conclude that they would be installed exactly the same way.

Also, contrary to Defendant's "Findings," Plaintiff did establish evidence of Defendant's contributory and induced infringement. As discussed above, D 30 itself goes a long way in establishing Defendant's contribution in assisting and encouraging its customers to assemble the components in an infringing configuration. However, the evidence does not stop there. Mr. Bortz testified that the EMB had no substantial use other than with the G4 or some related set like the G5. (Tr., vol. 2, pg. 67). He further testified that it was his belief that the customers wouldn't use it for anything other than with the G4 or G5. (Bortz' deposition, vol. 1, pg. 36). This is contributory infringement, plain and simple. Defendant's induced infringement flows from the fact that it supplied the general instructions and more specific D 30 instructions to its clients, as discussed above. Thus, when Defendant's "Findings" state that there is no evidence on the record to support a finding of Defendant's direct, contributory and induced infringement, they ring hollow and appear wholly unsubstantiated, and indeed contrary, to the great weight of the evidence.

Evidence of Plaintiff's Damages

Given the amount of evidence on the record regarding Defendant's willful infringement, there are substantial reasons for the Court to consider vacating Defendant's "Findings" and adopt Plaintiff's Findings. As previously presented by Plaintiff and accepted by this Court, actual damages were present, the Defendant's actions were willful and the case was exceptional. Even though Defendant received notice of the '159 patent on December 16, 1999, (Tr., vol. 2, pg. 192), it did little for about a year and a half other than have a couple of conversations with Mr. McLaughlin, who did not have all the information that he needed to render a reasonable opinion, all the while continuing its infringing activities. (Tr., vol. 1, pg. 181; Tr., vol. 1, pg. 200; Tr., vol. 1, pg. 202-03; Tr., vol. 2, pg. 181 and Peterson Company's Objection to Golden Blount's Motion for Updated Damages filed on September 18, 2002). Moreover, Defendant considered its infringement an insignificant financial matter because of the cheap cost of the EMB, and therefore, was not concerned until suit was filed on January 2001. At this point, Defendant finally became concerned, not with the damages associated with its infringing activity, but with the attorney's fees that it might be required to pay as a willful infringer. (Tr., vol. 2, pg. 60-62). Mr. Bortz' own testimony reveals that he told Mr. McLaughlin that this was not a very meaningful case "dollar wise" but that he heard a person might have to pay attorneys' fees if he lost a patent lawsuit. He asked Mr. McLaughlin what he should do. (Tr., vol. 2, pg. 60-62 & Dec. 19, 2001, deposition of Mr. Leslie Bortz, pg. 60). Mr. McLaughlin told him that one way that attorneys' fees could be avoided was

to obtain an opinion. (Id). This testimony not only repudiates Defendant's Findings, but underscores its error, reveals Defendants true willfulness, and is an irrefutable indication that Defendant's Findings are erroneous. In view of these facts, the record, as a whole, makes clear Defendant's willfulness, and it is contrary to Defendant's erroneous "Findings."

No Exceptional Case Against Plaintiff

In the midst of this dust storm, the Plaintiff certainly does not want the Court to lose sight of the most egregious and erroneous finding that exists in Defendant's "Findings"—the "finding" that Defendant is entitled to its attorneys' fees from Plaintiff due to Plaintiff's supposed vexatious and unjustified litigation. The Plaintiff has dealt with this issue in other documents filed with this Court, but because of the extraordinary nature of this "finding," Plaintiff will briefly reiterate those arguments.

This "finding" is not supported by the evidence in any respect. Defendant has proffered no evidence at all that supports the elements required by case law to sustain a finding of an exceptional case in favor of Defendant. Accordingly, the Defendant has not carried its burden by presenting clear and convincing evidence on the issue. Plaintiff's prosecution of its case was not vexatious or unjustified under case law. Defendant's "Findings" attempt to justify the award by asserting that because Defendant or none of its customers, supposedly at no time, infringed the '159 patent either directly, contributorily or by inducement, Plaintiff's continued prosecution of its case was vexatious and unjustified. The only argument that Defendant can muster is that Plaintiff was vexatious and unjustified because it should have been "obvious" to Plaintiff that it didn't have a case.

This "finding" is totally unsubstantiated, inasmuch as the record most assuredly supports a reasonable basis of a case of infringement against Defendant. Furthermore, Plaintiff has never engaged in any type of unreasonable conduct in prosecuting its case, which might support an award of attorneys' fees to Defendant. Plaintiff, at all times during these proceedings, has been reasonable and justified in prosecuting its case and has pressed its case in the best of faith. The testimony of both Mr. Bortz and Mr. Corrin, as discussed above, as well as the other evidence before this Court, is not only a reasonable case, but a compelling case of infringement on the part of Defendant.

Moreover, the claim interpretation, as adopted by this Court and affirmed by the Federal Circuit, and applied to Defendant's own Exhibit D 30, is further proof that Plaintiff was not unreasonable, vexatious, or

unjustified in bringing and prosecuting its case of infringement against Defendant. This was a claim interpretation that Plaintiff asserted during trial and used as the basis for pressing its infringement case. Plaintiff's continued assertion of a claim construction that was adopted by this Court and affirmed by the Federal Circuit cannot reasonably constitute vexatious or unjustified litigation.

Finally, Plaintiff respectfully reminds the Court that its previous judgment, which was entirely in Plaintiff's favor,¹² and that was affirmed in part, vacated in part and remanded by the Federal Circuit to this Court, serves as solid evidence, if not at least *prima facie* evidence, that Plaintiff's actions were reasonable, and therefore, were neither vexatious nor unjustified. Also, the Court should keep in mind that Defendant never presented any evidence at trial to support a finding of vexatious and unjustified litigation by Plaintiff. Defendant points to nothing more than unsubstantiated "Findings" and "Conclusions," neither of which are supported by any evidence whatsoever on the record. As mentioned above, case law requires that Defendant carry its burden by clear and convincing evidence. The evidence supporting Defendant's "Findings" is neither clear nor convincing but is, in truth, nonexistent. Furthermore, the Federal Circuit's affirmation of Plaintiff's claim construction gave this Court the justification to find the way it did at the end of trial, and certainly served, and still serves, as a good faith basis on which to rest an infringement action. Thus, there is no evidence or other justifiable basis on which to award Defendant its attorneys' fees in this case. Accordingly, this "finding" is grossly erroneous.

Conclusion

For the reasons set forth above, Defendant's Findings and Conclusions, as adopted by this Court, contain numerous manifest errors that are not supported by substantial evidence. Accordingly, Plaintiff reiterates its request that this Court vacate Defendant's Findings and Conclusions and adopt Plaintiff's Findings of Fact and Conclusions of Law, as previously submitted. Alternatively, Plaintiff requests a New Trial for the reasons previously stated above.

¹²The fact that this Court found for Plaintiff at the end of trial is clear proof that reasonable minds could differ about whether Defendant infringed or not, since the Court, at least at the end of trial, was thoroughly convinced that Defendant not only infringed, but willfully did so. There is no way that this judicial history should be ignored in now determining whether Plaintiff's case was vexatious or unjustified, and given this history, there can only be one conclusion....It wasn't.

Respectfully submitted,

For Plaintiff Golden Blount, Inc.

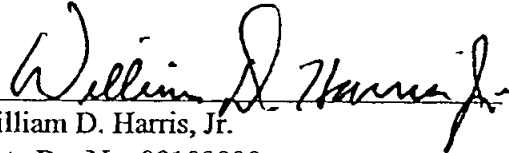

William D. Harris, Jr.

State Bar No. 09109000

SCHULTZ & ASSOCIATES, P.C.

5400 LBJ Freeway

One Lincoln Center, Suite 525

Dallas, Texas 75240

214/210-5940 (Telephone)

214/210-5941 (Facsimile)

Charles W. Gaines

State Bar No. 07570580

Greg H. Parker

State Bar No. 24011301

HITT GAINES, P.C.

2435 North Central Plaza

Suite 1300

Richardson, Texas 75080

972/480-8800 (Telephone)

972/480-8865 (Facsimile)

CERTIFICATE OF SERVICE

I hereby certify that a true copy of the enclosed Plaintiff, Golden Blount, Inc.'s Reply To Defendant's Opposition To Amend Findings, For Reconsideration And For A New Trial was served on the following counsel of record on August 9, 2004, by first class mail:

Jerry R. Selinger
Jenkins & Gilchrist
1445 Ross Avenue, Suite 3200
Dallas, Texas 75202
214/855-4500 (Telephone)
214/855-4300 (Facsimile)



William D. Harris, Jr.

EXHIBIT A

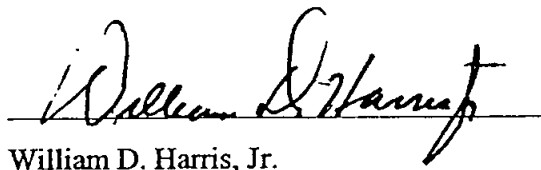
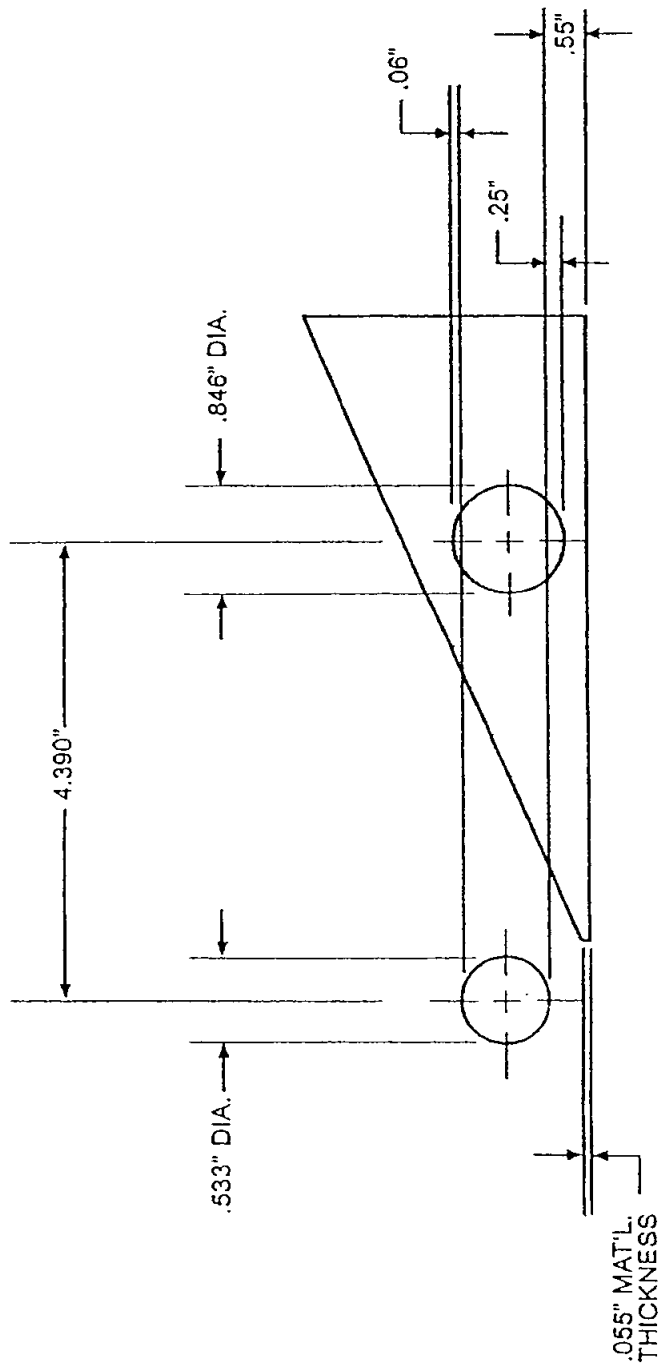

ROBERT H. PETERSON
 14724 E. PROCTOR AVE.
 INDUSTRY CA. 91746

EMB G4 REFERENCE #2

DATE: 02-15-02

SCALE: N/A

FILE#: 70508

DRAWN APPROVED

BY: R.P. BY: DATE:

R

IN THE UNITED STATES DISTRICT COURT
FOR THE NORTHERN DISTRICT OF TEXAS
DALLAS DIVISION

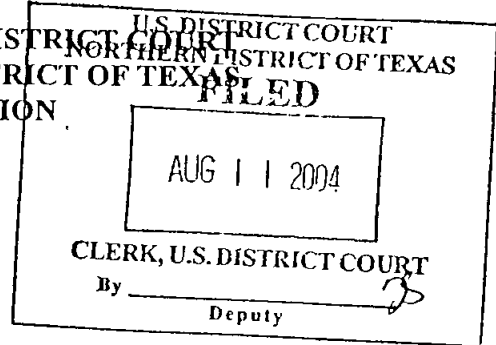

GORDON BLOUNT, INC.,

Plaintiff,

v.

ROBERT H. PETERSON CO.,

Defendant.

§
§
§
§
§
§
§
§
§
§

CA 3:01-CV-127-R

ORDER

DEFENDANT ROBERT H. PETERSON'S APPLICATION FOR ATTORNEY'S FEES (filed July 22, 2004) is hereby GRANTED.

IT IS SO ORDERED.

ENTERED: August 11, 2004.

JERRY BUCHMEYER
SENIOR UNITED STATES DISTRICT JUDGE
NORTHERN DISTRICT OF TEXAS

IN THE UNITED STATES DISTRICT COURT
FOR THE NORTHERN DISTRICT OF TEXAS
DALLAS DIVISION

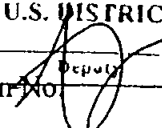
U.S. DISTRICT COURT DISTRICT OF TEXAS FILED <div style="border: 1px solid black; padding: 5px; text-align: center;"> AUG 31 2004 </div> CLERK, U.S. DISTRICT COURT By  Civil Action No. _____
--

GOLDEN BLOUNT, INC.,

Plaintiff,

v.

ROBERT H. PETERSON CO.,

Defendant.

§
§
§
§
§
§
§
§

3-01CV0127-R

FINDINGS OF FACT AND CONCLUSIONS OF LAW

This Court has conducted a bench trial on plaintiff Golden Blount Inc.'s claims against defendant Robert H. Peterson for a finding of infringement of U.S. Patent No. 5,988,159 and permanent injunction, and on Peterson's counterclaims of invalidity and non-infringement. In accordance with FED. R. CIV. P. 52(a) and consistent with the Court of Appeals for the Federal Circuit's Opinion¹ decided April 19, 2004, the Court enters the following findings of fact and conclusions of law.²

FINDINGS OF FACT

1. This is an action for patent infringement. The Court has subject matter jurisdiction under 28 U.S.C. §§ 1331, 1338(a). The Court has personal jurisdiction over the parties. Venue in this judicial district is proper under 28 U.S.C. § 1391.

¹ While the Appellate Court held that the patent was not invalid, and that the defense of unenforceability was waived, this Court includes general reference to these elements for completeness. *Golden Blount, Inc. v. Robert H. Peterson Co.*, 365 F.3d 1054 (Fed. Cir. 2004).

²This order contains both findings of fact ("Findings") and conclusions of law ("Conclusions"). To the extent that any Findings may be deemed conclusions of law, they shall also be considered Conclusions. To the extent that any Conclusions may be deemed findings of fact, they shall also be considered Findings. See *Miller v. Fenton*, 474 U.S. 104, 113-14, 88 L. Ed. 2d 405, 106 S. Ct. 445 (1985).

2. Plaintiff Golden Blount, Inc. ("Blount") is a United States corporation having a principal place of business in Addison, Texas.

3. Defendant Robert H. Peterson Co. ("Peterson") is a United States corporation having a principal place of business in City of Industry, California.

4. Blount is the owner by assignment of U.S. Patent No. 5,988,159 ("the '159 patent"), entitled "Gas-Fired Artificial Logs and Coals-Burner Assembly," which issued on November 23, 1999. The '159 patent expires on November 23, 2016.

5. Blount filed this suit for infringement of the '159 patent under 35 U.S.C. §§ 271(a) thru 271 (c) on January 18, 2001.

6. On March 19, 2001, Peterson filed its Answer and Counterclaim. Peterson denied infringement and asserted counterclaims for noninfringement and invalidity of the '159 patent.

7. A bench trial, by agreement of the parties, commenced on July 29, 2002, and ended on July 31, 2002.

8. Claims 1, 2, 5, 7-9, 11-13 and 15-17 are at issue in this case. Claims 1 and 17 are independent claims. All the other claims at issue are dependent on claim 1.

9. Claim 1 of the '159 patent reads as follows:

A gas-fired artificial logs and coals-burner assembly for fireplace comprising:
an elongated primary burner tube including a plurality of gas discharge ports;
a secondary coals burner elongated tube positioned forwardly of the primary burner tube;
a support means for holding the elongated primary burner tube in a raised level relative to the forwardly position secondary coals burner elongated tube;
the secondary coals burner elongated tube including a plurality of gas discharge ports;
the elongated primary burner tube and the secondary coals burner elongated tube communicating through tubular connection means wherein the gas flow to the secondary elongated coals burner tube is fed through the primary burner tube and the tubular connection means;
a valve for adjusting gas flow to the secondary coals burner elongated tube positioned in the tubular gas connection means; and

the primary burner tube being in communication with a gas source with a gas flow control means therein for controlling gas flow into said primary burner tube.

10. Claim 2 of the '159 patent reads as follows:

The gas-fired artificial logs and coals-burner assembly according to claim 1 wherein the support means for the primary burner tube is comprised of an open frame pan for supporting the primary burner tube in an elevated position relative to the fireplace floor.

11. Claim 5 of the '159 patent reads as follows:

The gas-fired artificial logs and coals-burner assembly according to claim 1 wherein the secondary coals burner elongated tube is substantially parallel to the primary burner tube and has a smaller inside diameter than the primary burner tube with the valve adjusting gas flow for coals burn and forwarding heat radiation from the fireplace.

12. Claim 7 of the '159 patent reads as follows:

The gas-fired artificial logs and coals-burner assembly according to claim 1 wherein the elongated primary burner tube and the secondary coals burner elongated tube are spaced apart on different planes at from about four to about eight inches.

13. Claim 8 of the '159 patent reads as follows:

The gas-fired artificial logs and coals-burner assembly according to claim 1 wherein the secondary coals burner elongated tube is of a smaller diameter than the primary burner tube which allows for a lower profile of coals and sand coverage.

14. Claim 9 of the '159 patent reads as follows:

The gas-fired artificial logs and coals-burner assembly according to claim 1 wherein the secondary coals burner elongated tube is adjustable in height relative to the floor of the fireplace and the elevated primary burner tube.

15. Claim 11 of the '159 patent reads as follows:

The gas-fired artificial logs and coals-burner assembly according to claim 1 wherein the primary and secondary burner tubes have apertures of from about 1/32 inch to about 1/8 inch.

16. Claim 12 of the '159 patent reads as follows:

The gas-fired artificial logs and coals-burner assembly according to claim 1 wherein the gas flow adjustment valve has a removable handle, the gas flow adjustment allowing a variety of settings from full closed to full open.

17. Claim 13 of the '159 patent reads as follows:

The gas-fired artificial logs and coals-burner assembly according to claim 1 wherein the connection means is comprised of a connector attached to the terminal end of the primary burner tube at a first end of a connector and attached to the secondary coals burner elongated tube to a connector second end with the valve interposed between the primary burner tube and the secondary burner tube.

18. Claim 15 of the '159 patent reads as follows:

The gas-fired artificial logs and coals-burner assembly according to claim 1 wherein the open frame pan and primary elongated burner tube is positioned under an artificial logs and grate support means.

19. Claim 16 of the '159 patent reads as follows:

The gas-fired artificial logs and coals-burner assembly according to claim 1 wherein the primary elongated burner tube is covered with sand and the secondary elongated burner tube is covered with sand, mica, and fibrous materials which simulate coals and ember burn.

20. Claim 17 of the '159 patent reads as follows:

A gas-fired artificial coals- and embers-burner apparatus suitable for attaching to a gas-fired primary artificial log burner tube said primary artificial log burner tube having a terminal end comprising:

a secondary coals burning elongated tube;

a connector means for connecting said terminal end in communication with the secondary burner tube, the secondary burner tube positioned substantially parallel, forward and below the primary burner tube, the connector means having interposed between the primary and secondary burner tubes a gas flow adjustment valve, the primary and secondary burner tubes having a plurality of gas discharge ports, the secondary burner tube being in gas flow communication with the primary burner tube being the connection means, a gas distribution ports of the secondary burner tube directed away from the fireplace opening.

21. At the time the patent issued, Blount's commercial structure covered by the '159 patent had been marketed for approximately six years. (Trial Transcript, hereafter referred to as "Tr.", vol. 1, pg. 158). The invention covered by the '159 patent is a simple yet very useful device that is to be used in artificial gas fireplaces. The general idea is that the device has two tubes, with the main or primary burner tube being higher than the ember burner tube to allow for artificial embers and sand to be fanned out over the tubes with a decreasing depth of materials to simulate a natural angle of repose of coals in a real fireplace. A secondary valve controls the flow of gas from the primary burner tube to the ember burner to allow for an adjustment of flame from the ember burner. Thus, with the presence of the ember burner forward the primary burner tube, more flame can be provided out front of the gas logs to better simulate a real fireplace and thereby make the artificial fireplace more aesthetically pleasing. Evidence presented at trial establishes that Peterson's accused device fulfills exactly the same purpose. (Tr. vol. 2, pg 175; Defendant's Ex. No. D-33).

22. Blount's sales of its commercial structure grew significantly during the time spanning the filing of the application that resulted in the '159 patent and the issuance of the '159 patent. (Tr., vol. 1, pg. 36-37).

23. In late 1996 or early 1997, Peterson began manufacturing, advertising and selling a device that was strikingly similar to, if not a virtual copy of, Blount's commercial structure. (Tr., vol. 2, pg. 76 and pg. 172).

24. Blount's '159 patent issued on November 23, 1999. (Plaintiff's Ex. No. 1).

25. Blount notified Peterson of the existence of the '159 patent and Peterson's infringing activities on December 16, 1999, using a certified letter postmarked December 10, 1999, from Mr. Dan Tucker (attorney for Blount) to Peterson's president, Mr. Leslie Bortz. (Plaintiff's Ex. No. 10).

26. This first certified letter included a copy of the '159 patent, and informed Peterson that Blount was prepared to take whatever steps were reasonable and necessary to prevent infringement. Blount requested a response regarding this matter from Peterson by January 14, 2000. (Plaintiff's Ex. No. 10).

27. On December 17, 1999, Mr. Tod Corrin (Peterson's Vice President) forwarded the December 10, 1999, certified letter onto Peterson's patent counsel, Mr. William McLaughlin. Mr. Corrin wrote, in a cover letter included with the copy of the first certified letter, "[e]nclosed is a *patent infringement* letter we received from Golden Blount's Attorney." (Plaintiff's Ex. No. 17, emphasis added). Given the letter from Blount's attorney and this acknowledgment by Mr. Corrin, this Court finds that Peterson had knowledge of its infringement of the '159 patent as of December 16, 1999.

28. On December 30, 1999, Peterson responded to Blount's letter of December 10, 1999, explaining that Peterson had forwarded the December 10, 1999, letter to its attorneys and that Peterson would get back with Blount as soon as possible. Given the December Holidays, as well as the New Year, Peterson informed Blount that Blount's January 14, 2000, response date was unreasonable. (Plaintiff's Ex. No. 11).

29. After receiving no response from Peterson for more than four months, Blount sent a second certified letter to Peterson on May 3, 2000, again informing Peterson of its patent infringement. The May 3, 2000, letter advised Peterson that Blount "will take [the] necessary steps to stop any such *infringement*." (Plaintiff's Ex. No. 12, emphasis added).

30. Peterson responded to the May 3, 2000, letter on May 16, 2000, that it disagreed with Blount's assertion that Peterson was marketing a device that was substantially similar to the burner assembly claimed in the '159 patent. Peterson further asked that Blount explain to it, in detail, the basis upon which Blount believed that Peterson was infringing the patent. (Plaintiff's Ex. No. 13). This Court finds that Peterson's disagreement lacks any serious credibility, since a simple comparison of the device

as illustrated in the '159 patent with Peterson's product would have revealed to any reasonable person that infringement was highly likely. Moreover, the record before this Court reveals that Peterson did not have any documents before it or its attorney at this time that provides a reasonable basis for this statement. Even though Blount did not give any explanation to Peterson, this did not relieve Peterson of its obligation to investigate in good faith whether it was in fact infringing the '159 patent. This Court further finds that the May 3, 2000, letter was written simply for the purpose of delay, or even with the hope that the infringement matter would go away. This Court, therefore, concludes that the request was not genuine.

31. On January 18, 2001, over a year after Peterson received its first notice of infringement letter, Blount filed suit. (Plaintiff's Ex. No. 14). Blount's initial notice letter of December 10, 1999, met the notice requirements under 35 U.S.C. § 287(a), and therefore, Peterson's additional information request did not relieve Peterson of its obligation to determine if it was infringing the '159 patent.

32. Blount sent a final letter on January 19, 2001, to Peterson advising Peterson that suit was brought in view of its failure to respond or indicate in any manner its intentions with respect to its infringing product. (Plaintiff's Ex. No. 14).

33. Peterson made no efforts to cease its infringing activities either in the time period spanning the December 10, 1999, letter and the January 19, 2001, letter, or for that matter, up and until the commencement of this trial. (Plaintiff's Ex. No. 17 & Updated Sales Figures provided by Peterson in response to this Court's request).

34. During the period between December 16, 1999, and September 19, 2002, Peterson sold 3,723 ember flame burner units ("ember burners"). (Tr., vol. 2, pg. 181 and Peterson Company's Objection to Golden Blount's Motion for Updated Damages filed on September 18, 2002).

35. Peterson's ember burner is intended to be attached to its G-4 series burner system or G-5 series burner system. (Joint Pretrial Order--Stipulations, pg. 6). In addition to selling the ember burner, Peterson also sells log sets that can be used with the ember burner and often uses the ember burner to entice their customers to come back in and buy new log sets. (Tr. vol. 2, pg 178).

36. The G-4 and G-5 series burner systems are substantially identical except that Peterson pre-assembles the G-5 burner system according to certain Canadian Gas Association specifications. (Tr., vol. 2, pg. 179).

37. At least 10 of the 3,723 Ember burners sold by Peterson were included on the pre-assembled G-5 series burner systems. (Oct. 5, 2001, deposition of Mr. Leslie Bortz, pg. 154-55).

38. At trial, Blount introduced Plaintiff's Exhibit No. 4A, which is one of Peterson's manufactured products including a Peterson G-4 burner pan with Peterson's ember burner attached to it. Blount properly laid foundation for this Plaintiff's Exhibit No. 4A through the testimony of one of Peterson's own witnesses, Mr. Jankowski, who stated that he recognized Plaintiff's Exhibit No. 4A as Peterson's products. (Tr. vol. 2, pg. 145). Also, Mr. Blount, whose business competes with Peterson's, identified Plaintiff's Exhibit No. 4A as being Peterson's competing product. (Tr. vol. 1, pg. 144). This Court also finds that foundation for this device is further established because the Court finds it to be virtually identical to the picture on page 3 of Peterson's own general installation instructions (introduced at trial by Peterson as Defendant's Ex. No. D-34), except for the valve knob, which is not at issue.

LITERAL INFRINGEMENT-DIRECT

39. The construction of the claims appears under paragraphs 120 thru 123 of the Conclusions of Law section. The determination of infringement based on the construed claims is factual and is therefore organized here under the Findings of Fact.

40. The analysis with respect to the literal infringement of claim 1 is as follows:

The first element of claim 1 reads: "an elongated primary burner tube including a plurality of gas discharge ports." Based upon the totality of the evidence, including un rebutted testimony of Mr. Golden Blount and this Court's own observations of the accused device, it is this Court's finding that the primary burner tube is the fundamental burner tube used in a majority of all gas operated fireplaces. Similarly, the plurality of gas discharge ports allow the flammable gas to escape from the primary burner tube and be ignited to provide a flame. Blount presented the un rebutted oral testimony of Mr. Blount, who using an infringement chart (Plaintiff's Ex. No. 9) as a guide, testified that Peterson's manufactured products include a primary burner tube having gas discharge ports therein. (Tr., vol. 1, pg. 45-50). In addition to this un rebutted testimony, this Court had the opportunity to closely observe an assembled version of Peterson's manufactured product³, wherein this Court observed Peterson's manufactured product having the primary burner tube including two or more gas discharge ports. (Tr., vol. 2, pg. 28).

³ See Finding of Fact No. 38, discussed above.

Peterson even admitted and stipulated to the presence of this element in its device. (Tr., vol. 2, pg. 173; Joint Pretrial Order--Stipulations, pg. 6). Further, Peterson never presented any evidence that its manufactured products did not contain the aforementioned claimed element. Thus, Peterson's manufactured products meet the first limitation of claim 1, which reads: "an elongated primary burner tube including a plurality of gas discharge ports."

41. The second element of claim 1 reads: "a secondary coals burner elongated tube positioned forwardly of the primary burner tube." Given the claim interpretation as set forth by the Court of Appeals for the Federal Circuit and based upon the totality of the evidence, the secondary coals burner elongated tube is positioned toward the opening of the fireplace, at least as compared to the primary burner tube, and is designed to provide a realistic flame, likened to a flame that might emanate from burning coals. Blount again presented evidence in the form of oral testimony of Mr. Blount, that Peterson's manufactured products include a secondary coals burner elongated tube, and that it is positioned forwardly of the primary burner tube. (Tr., vol. 1, pg. 45-50). Based on this Court's close observation of Peterson's manufactured product⁴, this Court finds that Peterson's manufactured products contain the claimed secondary coals burner elongated tube, which in Plaintiff's Exhibit No. 4A is Peterson's Ember Flame Booster (ember burner), and that it was positioned forwardly the primary burner tube. (Tr., vol. 2, pg. 28). Peterson even admitted and stipulated to the presence of this element in its device. (Tr., vol. 2, pg. 173; Joint Pretrial Order--Stipulations, pg. 6). Further, Peterson never presented evidence that conclusively established that its manufactured products did not contain the aforementioned claimed element. Thus, Peterson's manufactured products meet the second limitation of claim 1, which reads: "a secondary coals burner elongated tube positioned forwardly of the primary burner tube."

42. The third element of claim 1 reads: "a support means for holding the elongated primary burner tube in a raised level relative to the forwardly position[ed] secondary coals burner elongated tube." The previous two paragraphs already demonstrate that Peterson's manufactured products include both the elongated primary burner tube and the forwardly positioned secondary coals burner elongated tube. The only additional limitation added by this element is that a support means holds the elongated primary burner tube in a raised level relative to the secondary coals burner elongated tube. Peterson's manufactured products include a support means that holds the primary burner tube. Actually, Peterson's

⁴ See Finding of Fact No. 38, discussed above.

support means, which is an industry standard pan, is substantially identical if not completely identical, in shape and function to the support means illustrated in the '159 patent. (Tr., vol. 1, pg. 47). The question for this Court to rule on is whether Peterson's support means holds Peterson's elongated primary burner tube in a raised level relative to its secondary coals burner elongated tube. As affirmed by the Court of Appeal for the Federal Circuit, this Court construes the term "raised level" to mean that the top of the primary burner tube is at a raised level with respect to the top of the secondary burner tube. Blount offered evidence at trial that the top of Peterson's primary burner tube was higher than the top of Peterson's ember burner tube, by demonstrating before this Court, using a carpenter's level laid across the tops of the tubes of Plaintiff's Exhibit No. 4A, that Peterson's primary burner tube was raised with respect to its secondary burner. (Tr., vol. 2, pg. 28). Even Peterson's own patent attorney, Mr. McLaughlin, admitted during the demonstration that "assuming the table is level, the top of the front burner is below the top of the rear burner." (Tr., vol. 2, pg. 29). Also, Peterson's executive Mr. Bortz admitted that the top of the ember burner was lower than the top of the primary burner. (Tr., vol. 2, pg. 42). Similarly, Mr. Corrin testified that the tube is below the top of the main burner tube. (Tr., vol. 2, pg. 173 and Defendant's Ex. No. 8). The above evidence was, for the most part, unrebutted because Peterson based the majority of its case in chief on the argument that the relative height of the primary burner tube with respect to the secondary coals burner elongated tube should be measured from the bottoms of the respective tubes, or the ports. This Court further observed a general set of instructions included within the box of each ember burner, (Defendant's Ex. No. D-34 at pg. 3), which instructs the person assembling the device to tighten the Ember Flame Booster (ember burner) so that the valve faces forward and flush with the burner pan. According to the testimony of Mr. Bortz, the normal configuration is to have the valve resting on the fireplace floor because it serves as a support for the ember burner. (Leslie Bortz Deposition, vol. 1, pg. 70-71). At trial, and as observed by this Court, when the valve was resting on the table flush with the pan, the top of the primary burner was above the top of the ember burner. Additionally, Peterson actually offered to this Court, (Defendant's Ex. No. D-30), which it stated was provided to customers and installers to illustrate how to properly install the assembly. (Tr. vol. 2, pg. 183). While Defendant's Exhibit No. D-30 was offered in an attempt to establish non-infringement based upon Peterson's asserted bottoms test that it was proposing, the instructions clearly illustrate that Peterson's preferred installation has the tops of the primary burner tube being in a raised level with respect to the tops of the secondary coals burner elongated tube. Thus, given the above

discussed interpretation, and in view of the evidence presented, Peterson's manufactured products meet the third limitation of claim 1, which reads: "a support means for holding the elongated primary burner tube in a raised level relative to the forwardly position[ed] secondary coals burner elongated tube."

43. The fourth element of claim 1 reads: "the secondary coals burner elongated tube including a plurality of gas discharge ports." Blount again presented oral testimony of Mr. Blount that the secondary coals burner elongated tube of Peterson's manufactured products include a plurality of gas discharge ports. (Tr., vol. 1, pg. 45-50). Further, this Court's close observation of Peterson's manufactured product⁵ established that Peterson's secondary coals burner elongated tube includes a plurality of gas discharge ports. (Tr., vol. 2, pg. 28). Peterson also admitted to the presence of a plurality of gas discharge ports or jets, (Tr., vol. 2, pg. 174), and mentions this claimed element in its installation instructions. (Defendant's Ex. No. D-34). Further, Peterson never presented any evidence that its manufactured products did not contain the aforementioned claimed element that successfully rebuts Blount's evidence on this point. Thus, Peterson's manufactured products meet the fourth limitation of claim 1, which reads: "the secondary coals burner elongated tube including a plurality of gas discharge ports."

44. The fifth element of claim 1 reads: "the elongated primary burner tube and the secondary coals burner elongated tube communicating through tubular connection means wherein the gas flow to the secondary elongated coals burner tube is fed through the primary burner tube and the tubular connection means." Blount presented the oral testimony of Mr. Blount that Peterson's manufactured products include the tubular connection means and that the gas flow to the secondary elongated coals burner tube is fed through the primary burner tube and tubular connection means. (Tr., vol. 1, pg. 45-50). Additionally, this Court physically observed this claimed element in Peterson's manufactured product⁶, (Tr., vol. 2, pg. 28), and again notes that the illustration in Defendant's Exhibit No. D-34 shows this tubular connection means. Moreover, Peterson never presented any evidence that its manufactured products did not contain the aforementioned claimed element. Thus, Peterson's manufactured products meet the fifth limitation of claim 1, which reads: "the elongated primary burner tube and the secondary coals burner elongated tube communicating through tubular connection means wherein the gas flow to

⁵ See Finding of Fact No. 38, discussed above.

⁶ See Finding of Fact No. 38, discussed above.

the secondary elongated coals burner tube is fed through the primary burner tube and the tubular connection means.”

45. The sixth element of claim 1 reads: “a valve for adjusting gas flow to the secondary coals burner elongated tube positioned in the tubular gas connection means.” The evidence as established by Mr. Blount’s testimony, Peterson’s general instructions (Defendant’s Ex. No. D-34), and this Court’s own inspection of Plaintiff’s Exhibit No. 4A, confirms the presence of the valve. (Tr., vol. 1, pg. 45-50 and vol. 2, pg. 28). Peterson even admitted and stipulated to the presence of this element in its device. (Tr., vol. 2, pg. 173; Joint Pretrial Order--Stipulations, pg. 6). Further, Peterson never presented any evidence that its manufactured products did not contain the aforementioned claimed element. Thus, Peterson’s manufactured products meet the sixth limitation of claim 1, which reads: “a valve for adjusting gas flow to the secondary coals burner elongated tube positioned in the tubular gas connection means.”

46. The seventh element of claim 1 reads: “the primary burner tube being in communication with a gas source with a gas flow control means therein for controlling gas flow into said primary burner tube.” Blount again presented the oral testimony of Mr. Blount that the primary burner tube of Peterson’s manufactured products would ultimately be coupled to a gas source with a gas flow control means therein for controlling gas flow into the primary burner tube. (Tr., vol. 1, pg. 45-50). Furthermore, the parties stipulated prior to the commencement of the trial that “Robert H. Peterson Co.’s ember burner is intended to be attached to its G-4 series burner system or G-5 series burner system and the combined unit comprises a primary burner pipe, an ember pan that supports the primary burner pipe, a secondary burner tube and a valve that controls a flow of gas between the primary burner pipe and the secondary burner tube, and that an end user *would* connect the primary burner pipe to a gas source having a valve associated therewith.” (Joint Pretrial Order--Stipulations, pg. 6). Thus, Peterson’s manufactured products would ultimately meet the seventh limitation of claim 1, which reads: “the primary burner tube being in communication with a gas source with a gas flow control means therein for controlling gas flow into said primary burner tube.”

47. This Court finds that the above evidence is substantial and it clearly establishes that Peterson’s accused device contains each and every element of claim 1 of the ‘159 patent.

48. The evidence presented at trial establishes that Peterson provided its customers with two sets of installation instructions. One set was a general set of instructions, (Defendant’s Ex. No. D-34 at pg. 3), which instructs the person assembling the device to tighten the Ember Flame Booster (ember burner)

so that the valve faces forward and flush with the burner pan. According to the testimony of Mr. Bortz, the normal configuration is to have the valve resting on the fireplace floor because it serves as a support for the ember burner. (Leslie Bortz Deposition, vol. 1, pg. 70-71). At trial, and as observed by this Court, when the valve is resting on the table flush with the pan, the top of the primary burner is above the top of the ember burner. The other set of instructions, (Defendant's Ex. No. D-30), was very specific in the way in which the ember burner was to be oriented with respect to the primary burner. When the device is installed pursuant to these instructions, Defendant's Exhibit No. D-30 clearly shows that the top of the primary burner is above the top of the ember burner. Thus, both of these instructions consistently show that when the G-4 or the G-5 and the ember burner of Peterson's accused device are installed pursuant to these instructions, it would result in an infringing configuration.

49. Although Peterson did not make this argument at any time during trial, Peterson asserts on remand that Blount has not established direct infringement by it or its customers because Blount never directly proved how the devices were actually assembled. Peterson, instead relied on its case-in-chief that it did not infringe because of its urged claim construction and that the '159 patent was invalid, both of which this Court and the Federal Circuit rejected. Moreover, Peterson's position is against the weight of the evidence, both direct and circumstantial, in this case. This Court finds that the evidence clearly supports a case of direct infringement, not only by Peterson, but by its customers as well. Case law holds that when instructions are provided with an infringing device, it can be circumstantially inferred that the customer follows those instructions with respect to the accused device. Thus, it is reasonable for this Court to conclude that both Peterson and its customers would have assembled the devices in the way set forth in both sets of Peterson's assembly instructions. Peterson's direct infringement of claim 1 is established by the testimony of Messrs. Bortz and Corrin, both corporate officers of Peterson, who testified that Peterson assembled and operated the infringing device for distributors so they had the opportunity to see how the item worked. (Tr., vol. 2, pg. 65-66 and 199). In addition, Peterson itself assembled and sold at least 10 G-5 devices with a preassembled ember burner, which are the same as the G-4 except for being preassembled to comply with ANSI regulations. Mr. Bortz testified that he was sure that the ember burner was used with the G-5 because Peterson preassembled it and put it together, presumably in accordance with its own instructions. (Leslie Bortz Deposition, vol. 1, pg. 36). There has been no reasons given to this Court why Peterson didn't assemble these devices in accordance with its own instructions. Thus, the record establishes direct infringement on the part of Peterson itself.

50. Direct infringement by the ultimate purchasers of claim 1 is established by the evidence that proves that Peterson supplied all the required elements of claims 1, 15 and 17 of the '159 patent, as well as installation instructions, (Defendant's Ex. Nos. D-34 & D-30; Tr. vol. 2, pg. 177, 183), to its ultimate purchasers. It is reasonable to conclude that these instructions were used by Peterson's ultimate customers to assemble the ember burner, its associated components, and connect it to a gas source as stipulated by the parties. (Tr., vol. 1, pg. 45-50). These facts provide this Court with both direct and circumstantial evidence to find that direct infringement of claim 1 did indeed occur by Peterson's ultimate consumers.

51. Therefore, Blount has clearly established direct infringement on the part of Peterson and the ultimate purchaser of claim 1 of the '159 patent.

52. Dependent claim 15 includes all of the elements of independent claim 1 plus the element that "the open frame pan and primary elongated burner tube is positioned under an artificial logs and grate support means." Literal infringement of dependent claim 15 is particularly important because claim 15 includes the artificial logs and the grate support means. As set forth above, Peterson also manufactures and sells logs and other accessory items that can be sold with its G-4 or G-5 and the ember burner, and in fact uses the ember burner to entice customers to come back and buy new logs. (Tr., vol. 2, pg 178).

53. Sufficient evidence exists in the record to establish that Peterson's burner will ultimately be positioned under an artificial logs and grate support means. Therefore, Blount has clearly established direct infringement on the part of Peterson and the ultimate purchaser of claim 15 of the '159 patent.

54. This Court further concludes that in addition to directly infringing independent claims 1 & 15 of the '159 patent, Peterson and the ultimate purchasers directly infringe independent claim 17 of the '159 patent.

55. With the exception of a few additional elements included in independent claim 17 not included in independent claim 1, and a few elements included within independent claim 1 that are not included within independent claim 17, claims 1 and 17 are substantially similar.

56. Independent claim 17 does not include the claim limitation of independent claim 1 that the primary burner is in communication with a gas flow control means. Thus, this element need not be found in Peterson's manufactured products to find direct infringement by Peterson of independent claim 17.

57. The first element of independent claim 17 recites: “a secondary coals burning elongated tube,” and is similar to the fourth element of independent claim 1. Accordingly, the discussion above with respect to the fourth element of independent claim 1 may be applied to the first element of independent claim 17. Thus, Peterson’s manufactured products will ultimately meet the first limitation of claim 17, which reads: “a secondary coals burning elongated tube.”

58. The second element of independent claim 17 recites: “a connector means for connecting said terminal end in communication with the secondary burner tube, the secondary burner tube positioned substantially parallel, forward and below the primary burner tube, the connector means having interposed between the primary and secondary burner tubes a gas flow adjustment valve, the primary and secondary burner tubes having a plurality of gas discharge ports, the secondary burner tube being in gas flow communication with the primary burner tube being the connection means, gas distribution ports of the secondary burner tube directed away from the fireplace opening.”

59. Thus, independent claim 17 requires that the gas distribution ports of the secondary burner tube be directed away from the fireplace opening. As specifically construed and affirmed by the Court of Appeals for the Federal Circuit, this Court previously construed the term “directed away from” to mean that the gas ports of the secondary burner tube may be positioned in any direction that does not include a horizontal component pointed toward the vertical plane of the fireplace opening. *Golden Blount, Inc. v. Robert H. Peterson Co.*, 365 F.3d 1054, 1059-60 (Fed. Cir. 2004). Blount presented oral testimony of Mr. Blount that the gas ports of Peterson’s manufactured products are positioned directly down, which according to the above-referenced interpretation, are away from the fireplace opening. (Tr., vol. 1, pg. 45-50). In addition to this testimony, this Court closely observed an assembled version of Peterson’s manufactured product⁷, wherein it observed the manufactured product having the gas ports directed away from the fireplace opening. (Tr., vol. 2, pg. 28). Because Peterson believed the term “directed away from” would ultimately be construed to mean that the ports must be directed at least partially toward the back of the fireplace, Peterson went so far as to require the ports of its secondary burner tube to be positioned directly downward. Given the claim construction as construed and affirmed by the Federal Circuit, this required configuration results in a device that meets the “directed away from” limitation of claim 17.

⁷ See Finding of Fact No. 38, discussed above.

60. As the other claimed elements of the second limitation of independent claim 17 have been found in Peterson's manufactured products, as established above with respect to paragraphs 40 thru 46, this Court finds that the evidence establishes direct infringement by Peterson and by the ultimate purchasers of Peterson's products of claim 17. Moreover, the evidence establishes that Peterson itself directly infringed claim 17 when Peterson assembled the G-5 series burner systems and then sold them to customers.

61. Therefore, this Court finds that Peterson and the ultimate purchaser directly infringed at least claims 1, 15 and 17, as construed under paragraphs 120 thru 123 below, of the '159 patent.

LITERAL INFRINGEMENT-CONTRIBUTORY

62. Blount established at trial, through stipulation, that Robert H. Peterson Co.'s ember burner is intended to be attached to its G-4 series burner system or G-5 series burner system and the combined unit comprises a primary burner pipe, an ember pan that supports the primary burner pipe, a secondary burner tube and a valve that controls a flow of gas between the primary burner pipe and the secondary burner tube, and that an end user would connect the primary burner pipe to a gas source having a valve associated therewith. (Joint Pretrial Order--Stipulations, pg. 6).

63. Peterson was made aware of the '159 patent as early as December 16, 1999, by the letter from Mr. Tucker, which is referenced above. (Plaintiff's Ex. No. 10). Given these facts, it is clear that Peterson was aware that the combination for which its components were especially made was patented and infringing, as required by 35 U.S.C. § 271(c).

64. Blount further established through the testimony of Mr. Bortz that Peterson's ember burner is especially adapted for use in an infringement of the '159 patent, had no substantial non-infringing uses, and that it was intended to be used with both the G-4 and G-5 burner pans. (Tr., vol. 2, pg. 67; Leslie Bortz Deposition, vol. 1, pg. 36). Thus, the Court also finds that the testimony of Mr. Bortz and Mr. Corrin, as well as Mr. Blount, supports the fact that the ember burner was not a staple article of commerce.

65. As discussed above, this Court finds that direct infringement existed. For those units covered by stipulation for hookup, they were normally hooked up by professional installers or persons from the dealer. With their experience and relation to Peterson and with all of Peterson's literature (including Defendant's Ex. Nos. D-34 & D-30) one can count on proper installations pursuant to Peterson's

installation instructions as discussed above. Thus, each installation ultimately results in a direct infringement. (Tr., vol. 2, pg. 189). Blount has clearly proven contributory infringement on the part of Peterson of claims 1, 15 and 17 for those units.

LITERAL INFRINGEMENT-INDUCEMENT

66. The record establishes that Peterson sold the ember burner. In addition, the record also establishes that Peterson sold the G-4, which includes the primary burner and support pan, and sold the G-5, ten at least of which, had the ember burner attached. Further, given the stipulation that the ultimate assembly would be connected to a gas source, there is sufficient basis to conclude that Peterson knew or should have known that this ultimate configuration would infringe independent claims 1 and 17. (Joint Pretrial Order--Stipulations, pg. 6).

67. Peterson was made aware of the '159 patent as early as December 16, 1999, by the letter of December 10, 1999, from Mr. Tucker, which is referenced above. (Plaintiff's Ex. No. 10). Given these facts, it is clear that Peterson was aware that the combination for which its components were especially made was patented and infringing.

68. The record is also clear that Peterson provided literature and assembly instructions to consumers, as discussed above, detailing how to install the components in a preferred configuration, which induced its customers to install the components in an infringing manner. (Tr., vol. 2, pg. 173-174, 177, 183; Defendant's Ex. Nos. D-34 & D-30). Also, Peterson fully assembled and hooked up in a fireplace an accused structure and demonstrated it and its use to independent distributors, which this Court finds to be a substantial inducement.

69. Because Peterson provided the consumers with detailed instructions, (Defendant's Ex. Nos. D-34 & D-30), how to assemble the parts in an infringing manner, and given the fact that Peterson had knowledge of the '159 patent by way of the notice letter of December 16, 1999, Peterson knew or should have known that such actions would induce direct infringement. Thus, there is little doubt and almost a certainty that the installation was in fact done in accordance with Peterson's published installation instructions. The demonstrations of a properly connected device to distributors further shows inducement because this information was passed on to dealers and ultimately to assemblers and customers. Invariably, infringement occurred. (Tr., vol. 2, pg. 189).

70. As found by this Court in paragraphs 40 thru 61 above, there was direct infringement by Peterson or its ultimate purchasers of claims 1, 15 and 17 of the '159 patent.

71. Accordingly, this Court finds that in those instances where direct infringement by Peterson was not conclusively established on a unit by unit basis, Blount has clearly proven induced infringement on the part of Peterson of claims 1, 15 and 17 for those units.

72. Because Peterson's manufactured products literally infringe claims 1, 15 and 17 of the '159 patent, they infringe the patent. Thus, comparison of Peterson's product to the remaining claims depending from independent claim 1, whether it be in determining direct infringement, contributory infringement or induced infringement, is generally unnecessary and is therefore not addressed herein.

INFRINGEMENT-DOCTRINE OF EQUIVALENTS

73. Blount offered unrebutted testimony at trial that every element of Peterson's manufactured products perform substantially the same function in substantially the same way to obtain the same result as the claimed elements of the '159 patent. (Tr., vol. 1, pg. 59-60).

74. Blount further offered unrebutted testimony by Mr. Blount at trial that any difference between Peterson's manufactured products and the claim elements were insubstantial at best. Mr. Blount actually testified that they were an exact copy. (Tr., vol. 1, pg. 30, 37, 46, 48, 56 and 60). In addition, through this Court's own observance of the accused product 4A, this Court finds that there was a substantial equivalent of each and every element of at least claims 1, 15 and 17 in Peterson's accused products.

75. Based on the evidence presented to it, this Court finds that there is no prosecution history estoppel that limits the range of equivalents regarding the claimed elements.

76. Thus, this Court finds that in those instances where literal infringement might not exist, there is infringement of the claims of the '159 patent under the doctrine of equivalence.

77. In summation, this Court concludes that Blount established literal infringement (e.g., directly, by inducement, or contributorily) or infringement under the doctrine of equivalents, each of claims 1, 15 and 17 of the '159 patent, by Peterson by at least a preponderance of the evidence.

DAMAGES

78. Damages have been determined using the *Panduit* factors. Mr. Blount testified for Blount at trial as to the demand that existed for the product during the period in question. (Tr., vol. 1, pg. 61). Thus, Blount has conclusively established the first required element of *Panduit*.⁸

79. In addition to establishing a demand for the patented product during the period in question, Blount established an absence, during the period of infringement, of acceptable non-infringing substitutes. (Tr., vol. 1, pg. 63-65).

80. Peterson argued that other acceptable non-infringing substitutes exist.

81. Here the patented product offers quite unique and novel results. (Tr., vol. 1, pg. 28-30). The so called "acceptable non-infringing substitutes" Peterson has introduced are either not acceptable, or they too infringe, although no third party infringing device was offered by either side.

82. Blount established at trial that Peterson's front flame director was not an acceptable substitute. (Tr., vol. 2, pgs. 184, 195). Peterson's own Vice President, Mr. Corrin, testified that the front flame director lacked the valve for adjusting the height of the front flame. Even more telling, Mr. Corrin testified that the front flame director was not as good as their ember burner. (Tr., vol. 2, pgs. 184, 195).

83. As the valve to adjust the height of the front flame is one of the particular features available only from the patented product, under the law set forth in *Standard Havens*, the front flame director, lacking that valve or any adjustment means, is not an acceptable non-infringing substitute.

84. Peterson further argues that Blount admitted at trial that at least five products on the market perform roughly the same function as Blount's patented device. (Tr., vol. 1, pg. 63). The record is clear that those five products were infringing substitutes and not acceptable non-infringing substitutes. (Tr., vol. 1, pg. 63). In fact, the record indicates that Blount sent the manufactures of those five products the identical notice of infringement letter at the same time it sent Peterson its letter. (Tr., vol. 1, pg. 63). No evidence exists in the record that the aforementioned five instances of infringement continued after the notice of infringement letters were received. In fact, Mr. Blount's testimony indicates that while the other companies were moving in and were interested in the outcome of this trial, none were still infringing after receipt of their notice of infringement letter. (Tr., vol. 1, pg. 62-64).

⁸ See the Conclusions of Law section, paragraph 151, where the *Panduit* factors are set forth.

85. Therefore, this Court finds that Blount provided sufficient evidence to support the finding that there were no acceptable non-infringing substitutes that could have decreased the market share Blount and Peterson together held. Thus, Blount has conclusively established the second required element of *Panduit*.

86. Blount also offered sufficient evidence through Mr. Blount's testimony that Blount had more than enough manufacturing and marketing capability to promote the device, thus entitling Blount to actual damages. (Tr., vol. 1, pgs. 62, 66). Thus, Blount has conclusively established the third required element of *Panduit*.

87. Because the *Panduit* factors have been established, it is reasonable for this Court to infer that the lost profits claimed were in fact caused by Peterson's infringing sales. This Court now only needs to determine a detailed computation of the amount of profit Blount would have made, to meet the final required element of *Panduit*.

88. In addition, however, the Court also finds that the facts of the present case establish a two-supplier market. Blount offered evidence through the testimony of Mr. Blount that Blount and Peterson together held approximately 95 percent or more of the market associated with ember burners similar to that covered by the '159 patent. (Tr., vol. 1, pg. 64). While Peterson attempted to impeach Mr. Blount's testimony on this point, this Court finds that Peterson failed to do so. Therefore, this Court finds that Mr. Blount's testimony is sufficient to establish a two supplier market. The supposed 5 percent of the market that Blount and Peterson might not have held is de minimus, and therefore, for damage calculations a two-supplier market has been found to exist in this case. Therefore, causation may be inferred, that is, "but for" Peterson's infringing activities, Blount would have made the sales it normally would have made.

89. To determine the actual damage amount in a lost profit case, the Court can multiply Blount's per unit profit times the number of infringing devices that Peterson sold.

90. To do this, however, the Court must determine the device upon which lost profits are to be calculated.

91. Using two different approaches, Blount has established that the device for calculating lost profits includes the entire burner assembly (including the secondary burner and valve), the grate, and a full set of artificial logs. This Court finds that Blount ultimately lost the sale of the entire burner assembly (including the secondary burner and valve), the grate, and a full set of artificial logs.

92. Dependent claim 15, which was established as literally infringed above, recites that the gas-fired artificial logs and coals-burner of claim 1 are positioned under artificial logs and a grate support means. Because the artificial logs and the grate support means are positively claimed in dependent claim 15, the artificial logs and the grate support means should be included in the device upon which damages for direct infringement as well as lost profits are to be calculated.

93. Accordingly, the device for calculating lost profits includes the entire burner assembly (including the secondary burner and valve), the grate and a full set of artificial logs, which must be the case here, because apart from the artificial logs and grate, the coals burner unit has no purpose or function.

94. Given the circumstances, the entire market value rule is appropriate here as an alternative, second approach. Evidence was offered at trial by Peterson's own officer, Mr. Corrin, that Peterson used the ember burner to entice customers to come back to the store to purchase newer log sets, and at the same time, purchase Peterson's ember burner, which improved the overall appearance of the fireplace. (Tr., vol. 2, pg. 177-79). These facts are sufficient to establish that the ember burner is the basis for the customer's demand, as set forth by *TWM*, see *infra*.

95. Blount also offered evidence that the glowing embers from the ember burner are what draws a customer's attention to a particular log and burner set, and what ultimately makes the sale. (Tr., vol. 1, pg. 157-63).

96. Blount also offered testimony at trial that the elements of independent claims 1 and 17 constitute a functional unit with the artificial logs and the grate support.

97. Blount presented a third-party witness retailer, Mr. Charlie Hanft of Atlanta, with extensive sales experience with gas fireplaces and ember burner and gas log sets. He testified that 97 ½ percent of the time that he sells an ember burner, he also sells an entire burner assembly and log set with it. (Tr., vol. 1, pg. 160). Peterson did not successfully rebut Blount's evidence on this point because Peterson presented no testimony to quantify even in a general way when the two would not ultimately be sold together.

98. Peterson failed to rebut Blount's evidence because it did not offer any numerical evidence regarding how often it sells one of its Ember burners with the entire burner and log set.

99. In summation of this point, Blount introduced testimony as to the standard practice in the industry for selling the ember burner, and Peterson failed to introduce its own testimony to rebut Blount's testimony.

100. Because the evidence establishes that 97 ½ percent of the sales of the ember burner would also encompass the sale of the entire burner assembly and log set, the record supports a proration of the damage amount based upon this percentage.

101. Based on the record, of the 3,723 EMB's sold by Peterson, 2 ½ percent (i.e., 94 EMB's) were sold without an associated burner assembly and log set, and the remaining 97 ½ percent (i.e., 3,629) were sold with an associated burner assembly and log set.

102. Blount established at trial that its profit on the ember burner alone is \$14.09 per unit and its profit on the ember burner, entire burner assembly and full set of logs is \$117.92 per unit. (Plaintiff's Ex. No. 18).

103. This Court finds, based on the percentages and profits established in the paragraphs above, that the total actual damages amount to \$429,256.

WILLFULNESS / EXCEPTIONAL CASE

104. Having carefully reviewed the record herein, the Court concludes that Peterson's minimal attempt to attain a competent opinion is permeated by a lack of due care and was willful, which leads this Court to find that the case is exceptional. Blount has established by clear and convincing evidence that Peterson's supposed oral opinion was an incompetent, conclusory opinion to be used only as an illusory shield against a later charge of willful infringement, rather than in a good faith attempt to avoid infringing another's patent.

105. Throughout the 2½ years from the time the first notice letter was sent, Peterson simply never obtained a single written opinion suggesting that their commercial embodiment avoided infringement. Also, the denial that the first letter related to notice of infringement is shown unlikely by Mr. Corrin's own characterization of it as an "*infringement letter*" in his correspondence with his patent counsel. (Tr., vol. 2, pg. 192). Also, this Court finds it disingenuous for Peterson to argue at trial that the interrogatories answered well after suit was filed and during discovery, form the written opinion upon which they relied.

106. The first time Peterson spoke to Mr. McLaughlin was on or about December 30, 1999, however, Mr. McLaughlin did not have the accused infringing device at this time. (Tr., vol. 1, pg. 181). The record establishes that Mr. McLaughlin, at this time, only had a picture of the accused infringing device.

(Tr., vol. 1, pg. 181). Neither did Mr. McLaughlin have the prosecution history of the '159 patent at this time, which is an important element of any competent opinion. (Tr., vol. 1, pgs. 183, 202-03).

107. This non-substantive conversation cannot be construed to be an opinion upon which Peterson could reasonably rely because it was based solely on a supposition. This supposition amounted to a representation on the part of Mr. Bortz that the invention had been around 20 to 30 years. (Tr., vol. 2, pg. 55-56). Mr. McLaughlin, with only the evidence listed above, said that "if we *could* prove that the invention had been around for 20 to 30 years then it *would* be a strong argument of invalidity." (Tr., vol. 2, pg. 55-56, emphasis added). This "if this, then that" statement plainly does not amount to an opinion upon which a prudent person could reasonably rely.

108. Importantly, this Court has found that Peterson made no further efforts to determine whether it was truly infringing or not, until after suit was filed, almost a year and two months after receiving the first notice letter. (Tr., vol. 1, pg. 202-03).

109. Peterson argues that it did nothing further because it was awaiting "additional information or further explanation from Blount's attorney." This Court finds this argument lacking merit. Blount did not, after sending multiple notice of infringement letters to Peterson under the law, owe Peterson any obligation with regard to advising Peterson how they actually were infringing.

110. Nevertheless, Blount's failure to respond to Peterson's additional information request did not relieve Peterson of its obligation to determine if it was willfully infringing the '159 patent.⁹ To the contrary, Peterson continued its infringing activities even after May 16, 2000, and actually even through the trial proceedings. (Tr., vol. 2, pg. 181 and Peterson Company's Objection to Golden Blount's Motion for Updated Damages filed on September 18, 2002). This reflects an egregious and willful disregard for the '159 patent.

111. It was not until after the lawsuit was filed in January 2001 that Peterson finally became concerned, not with the damages associated with the infringing activity, but apparently with the attorney's fees that Peterson might be required to pay as a willful infringer. (Tr., vol. 2, pg. 60-62). By Mr. Bortz' own admission, he told Mr. McLaughlin that this was not a very meaningful case "dollar wise" but that he heard a person might have to pay attorneys' fees if he loses a patent lawsuit, and he asked Mr. McLaughlin what he should do. (Tr., vol. 2, pg. 60-62 & Dec. 19, 2001, deposition of Mr.

⁹ See also, Finding of Fact No. 30.

Leslie Bortz, pg. 60). Mr. McLaughlin told him that one way that attorney's fees could be avoided was by obtaining an opinion. (Id). This set of facts underscores Peterson's true intentions with respect to its willful disregard of the '159 patent, that it was concerned more with having to pay attorneys' fees than it was with its own infringement. The Court finds that this constitutes an intentional disregard for the '159 patent on the part of Peterson.

112. At no time when Mr. McLaughlin gave Mr. Bortz advice did Mr. McLaughlin ever see the actual accused structure. (Tr., vol. 1, pg. 181). While some advertisements of Peterson's structure were shown, detailed drawings were never provided at this time to Mr. McLaughlin, including the installation instructions that were apparently sold with the device. Thus, Mr. McLaughlin never had a full understanding of the accused structure, (Tr., vol. 1, pg. 200), and Mr. McLaughlin should have known that his opinion would not be reasonable without such an understanding.

113. While Peterson argues that three oral consultations occurred, this Court finds that only one oral opinion of counsel, if it can even be called that, was rendered. This oral opinion was rendered by Mr. McLaughlin on or about May 1, 2001, about 4 months after suit had been filed and 2½ years after Peterson was first noticed of its infringing activity. (Tr., vol. 1, pg. 179-83).

114. This Court believes that Peterson did get what it asked for, a statement that there was no infringement. Peterson's primary desire, however, was to avoid paying attorneys' fees or increased damages, and this appears to have been the sole reason for consultation with counsel, and these actions show a willful and egregious disregard for the '159 patent.

115. In summary, this Court finds that Peterson had three consultations with its Attorney. All were oral. Only the last oral consultation approached what was needed to determine infringement and validity issues, and even it was made with a search limited to the company's own records and with there having been no accused structure shown the patent attorney. This third consultation occurred a number of months after suit had been filed and was motivated by the apprehension of Peterson having to pay attorneys' fees, and not for a concern of infringement of the '159 patent.

116. Peterson's cavalier attempt to obtain an opinion and the non-persuasive trial testimony of Peterson's witnesses are classic examples of conduct that clearly and convincingly demonstrates an exceptional case, an indication of which is gross wilfulness.

117. This Court therefore finds that the infringement of Peterson was willful, thus the actual damages are trebled, totaling \$1,287,766.

118. Given Peterson's conduct and its overall willful disregard for the '159 patent, such an award is appropriate here. The Court finds that as a result of Peterson's continued infringement, without a reasonable basis for believing that it had a right to make, use or sell its product prior to the expiration of the '159 patent, Blount has been compelled to prosecute an infringement claim at great expense. Under these circumstances, an award of attorneys' fees is proper in addition to the enhanced damage award.

119. This Court therefore finds this to be an exceptional case under 35 U.S.C. § 285, thus reasonable attorneys' fees are awarded to Blount.

CONCLUSIONS OF LAW

CLAIM CONSTRUCTION

120. The parties dispute the meaning of two terms in the claims of the patent in suit, namely the phrase "raised level," as recited in claim 1, and the term "below" and the phrase "away from the fire place opening," as recited in claim 17.

121. As affirmed by the Court of Appeals for the Federal Circuit in its opinion dated April 19, 2004, this Court construes that the term "at a raised level" in claim 1 refers to the top of the two burner tubes, and that the tops of the tubes should be used to determine whether the primary burner tube is held at a raised level with respect to the secondary burner tube as recited in claim 1. This Court also construes that the term "below" in claim 17 refers to the tops of the two burner tubes, and that the tops of the tubes should be used to determine whether the secondary burner tube is positioned below the primary burner tube as recited in claim 17. *Golden Blount, Inc. v. Robert H. Peterson Co.*, 365 F.3d 1054, 1059-60 (Fed. Cir. 2004).

122. As affirmed by the Court of Appeals for the Federal Circuit in its opinion dated April 19, 2004, this Court construes the term "away from the fireplace opening" to mean that the gas ports may be positioned in any direction that does not include a horizontal component pointed toward the vertical plane of the fireplace opening. *Id.*

123. All the other terms in the claims at issue are construed to have a plain and ordinary meaning, which appear not to have been contested at trial.

VALIDITY

124. A validity analysis begins with the presumption of validity. An issued patent is presumed valid. 35 U.S.C. § 282.

125. An “accused infringer who raises patent invalidity as a defense bears the burden of showing invalidity by facts supported by clear and convincing evidence.” *Robotic Vision Systems, Inc. v. View Engineering, Inc.*, 189 F.3d 1370, 1377 (Fed. Cir. 1999); *Weatherchem Corp. v. J.L. Clark, Inc.*, 163 F.3d 1326, 1334-35 (Fed. Cir. 1998).

126. As affirmed and determined by the Court of Appeals for the Federal Circuit on April 19, 2004, this Court concludes that Peterson has failed to prove by clear and convincing evidence that the ‘159 patent is invalid. This Court therefore finds the ‘159 patent not to be invalid. *Golden Blount, Inc.* at 1061-62.

LITERAL INFRINGEMENT-DIRECT

127. The claims define the metes and bounds of the invention, and only they may be infringed. *SmithKline Diagnostics, Inc. v. Helena Labs. Corp.*, 859 F.2d 878, 882 (Fed. Cir. 1988); *Corning Glass Works v. Sumitomo Elec. USA, Inc.*, 868 F.2d 1251 (Fed. Cir. 1989).

128. The patentee’s burden is to show literal infringement by a preponderance of the evidence. *Braun v. Dynamics Corp.*, 975 F.2d 815 (Fed. Cir. 1992).

129. A patent claim is literally infringed if the accused product or process contains each element of the claim. *Tate Access Floors v. Maxcess Techs.*, 222 F.3d 958, 964 (Fed. Cir. 2000); *Uniroyal, Inc. v. Rudkin-Wiley Corp.*, 837 F.2d 1044, 1054 (Fed. Cir. 1988). If each element is present, literal infringement exists and “that is the end of it.” *Graver Tank v. Linde Co.*, 339 U.S. 605, 607, 94 L. Ed. 1097, 70 S. Ct. 854, 1950 Dec. Comm’r Pat. 597 (1950).

130. In determining infringement, the accused product is compared to the patent claims, not the patentee’s product. *Zenith Laboratories, Inc. v. Bristol-Myers Squibb Co.*, 19 F.3d 1418, 1423 (Fed. Cir. 1994); *Glaxo Inc. v. TorPharm Inc.*, 153 F.3d 1366, 1373 (Fed. Cir. 1998).

131. Infringement of a single claim is infringement, *Panduit Corp. v. Dennison Mfg. Co. Inc.*, 836 F.2d 1329, 1330 n.1 (Fed. Cir. 1987); *Intervet America v. Kee-Vet Laboratories*, 887 F.2d 1050, 1055

(Fed. Cir. 1989), and entitles the patentee to the full panoply of statutory remedies. *Intervet*, 887 F.2d at 1055.

132. If one is arguing that proof of inducing infringement or direct infringement requires *direct*, as opposed to *circumstantial evidence*, the Federal Circuit disagrees. It is hornbook law that direct evidence of a fact is not necessary. "Circumstantial evidence is not only sufficient, but may also be more certain, satisfying and persuasive than direct evidence." *Metabolite Laboratories, Inc. v. Laboratory Corp. of America*, 370 F.3d 1354, 1365 (Fed. Cir. 2004) (citing *Moleculon Research Corp. v. CBS, Inc.*, 793 F.2d 1261, 1272 (Fed. Cir. 1986)).

133. In determining whether a product claim is infringed, the Federal Circuit has held that an accused device may be found to infringe if it is reasonably capable of satisfying the claim limitations, even though it may also be capable of non-infringing modes of operation. See, *Intel Corp. v. United States Int'l Trade Comm'n*, 946 F.2d 821, 832, 20 USPQ2d 1161, 1171 (Fed.Cir.1991); *Key Pharms., Inc. v. Hercon Labs. Corp.*, 981 F.Supp. 299, 310 (D.Del.1997), *aff'd*, 161 F.3d 709, 48 USPQ2d 1911 (Fed.Cir.1998); *Huck Mfg. Co. v. Textron, Inc.*, 187 USPQ 388, 408 (E.D.Mich.1975) ("The fact that a device may be used in a manner so as not to infringe the patent is not a defense to a claim of infringement against a manufacturer of the device if it is also reasonably capable of a use that infringes the patent."); *cf. High Tech Med. Instrumentation, Inc. v. New Image Indus., Inc.*, 49 F.3d 1551, 1556, 33 USPQ2d 2005, 2009 (Fed.Cir.1995).

134. Circumstantial evidence of product sales and instructions indicating how to use the product is sufficient to prove third party direct infringement. *Moleculon Research Corp. v. CBS, Inc.*, 793 F.2d 1261, 1272 (Fed. Cir. 1986).

135. This Court understands that in determining infringement, the accused product is compared to the patent claims, not the patentee's product. However, FIG. 2 of the '159 patent is representative of the claims of the '159 patent and the claims may be read on the FIG. 2 structure. For this reason a comparison of one of Blount's devices and Peterson's manufactured product is highly instructive for purposes of this Court's analysis, and is, therefore, provided.

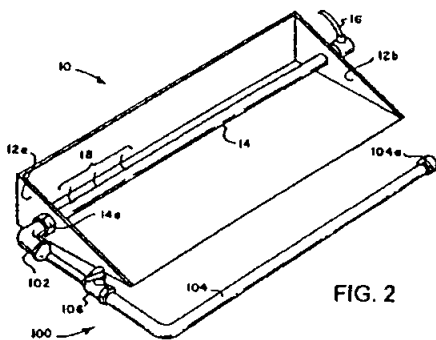

Blount's Patented Device
FIG. 2 of the '159 patent

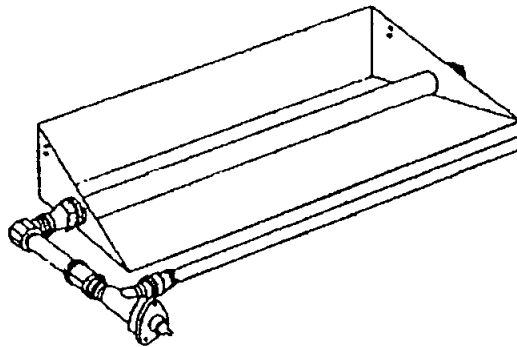

Peterson's Manufactured Product
Figure 2 of Peterson's Installation Instructions
without the control knob shown

136. The findings in the sections above make out a clear case of direct infringement on all of the devices sold.

LITERAL INFRINGEMENT-CONTRIBUTORY

137. Contributory infringement liability arises when one "sells within the United States . . . a component of a patented machine . . . constituting a material part of the invention, knowing the same to be especially made or especially adapted for use in an infringement of such patent, and not a staple article or commodity of commerce suitable for substantially noninfringing use." 35 U.S.C. § 271(c) (2002).

138. Thus, Blount must show that Peterson "knew that the combination for which its components were especially made was both patented and infringing." *Preemption Devices, Inc. v. Minn. Mining & Mfg. Co.*, 803 F.2d 1170, 1174 (Fed. Cir. 1986).

139. An appropriate infringement notice letter from the patentee to the accused infringer provides the requisite knowledge required by 35 U.S.C. § 271(c). *Aro Manufacturing Co., Inc. v. Convertible Top Replacement Co.*, 377 U.S. 476, 490 (1964).

140. Further, Blount must show that Peterson's components have no substantially noninfringing uses, while meeting the other elements of the statute. *Alloc, Inc. v. ITC*, 342 F.3d 1361, 1374 (Fed. Cir. 2003).

141. It is not necessary for a plaintiff to make the direct infringer a party defendant in order recover on a claim of contributory infringement. It is enough for the plaintiff to prove, by either circumstantial

or direct evidence, that a direct infringement has occurred. *Amersham International PLC v. Corning Glass Works*, 618 F. Supp. 507 (D. Mich., 1985).

142. The findings in the sections above make out a clear case of Contributory infringement on all of the devices sold.

LITERAL INFRINGEMENT-INDUCEMENT

143. In order to find Peterson liable for inducing infringement under 35 U.S.C. § 271 (b), Blount must show that Peterson took actions that actually induced infringement. *Met-Coil Sys. Corp. v. Korners Unlimited, Inc.*, 803 F.2d 684, 687 (Fed. Cir. 1986) (“There can be no inducement of infringement without direct infringement by some party.”)

144. Further, Blount must show that Peterson knew or should have known that such actions would induce direct infringement. *Micro Chem. Inc. v. Great Plains Chem. Co.*, 194 F.3d 1250 (Fed. Cir. 1999).

145. Dissemination of instructions along with sale of the product to an ultimate consumer is sufficient to prove infringement by an inducement. *Moleculon Research Corp. v. CBS, Inc.*, 793 F.2d 1261, 1272 (Fed. Cir. 1986). Thus, Blount has met its burden of showing infringement under section 35 U.S.C. 271(b).

146. The findings in the sections above make out a clear case of induced infringement on all of the devices sold.

INFRINGEMENT-DOCTRINE OF EQUIVALENTS

147. Infringement under the doctrine of equivalents occurs when a claimed limitation and the accused product perform substantially the same function in substantially the same way to obtain the same result. See *Warner-Jenkinson Co. v. Hilton-Davis Chem. Co.*, 520 U.S. 17, 39-40, 137 L. Ed. 2d 146, 117 S. Ct. 1040 (1997).

148. Infringement under the doctrine of equivalents also requires that any difference between the claim elements at issue and the corresponding elements of the accused product be insubstantial. *Id.*

149. This Court finds alternatively (or cumulatively) that there was infringement under the doctrine of equivalents.

DAMAGES

150. To recover lost profit damages, the patentee need only show causation and the factual basis for causation between the infringement and the lost profits. *Lam, Inc. v. Johns-Manville Corp.*, 718 F.2d 1056, 1065, 219 U.S.P.Q. 670 (Fed. Cir. 1983).

151. To do this, *Panduit* established that the patent owner need only demonstrate:

- 1) a demand for the product during the period in question;
- 2) an absence, during that period, of acceptable non-infringing substitutes;
- 3) its own manufacturing and marketing capability to meet or exploit that demand; and
- 4) a detailed computation of the amount of the profit it would have made.

Panduit Corp. v. Stahlin Bros. Fibre Works, Inc., 575 F.2d 1152, 1156, 197 U.S.P.Q. 726 (6th Cir. Mich. 1978); *Radio Steel & Mfg. Co. v. MTD Prods., Inc.*, 788 F.2d 1554, 1555, 229 U.S.P.Q. 431 (Fed. Cir. 1986).

152. In a two-supplier market it is reasonable to assume, provided the patent owner has the manufacturing capabilities, that the patent owner would have made the infringer's sales but for the infringement. *State Indus. v. Mor-Flo Indus.*, 883 F.2d 1573, 1578, 12 U.S.P.Q.2d 1026 (Fed. Cir. 1989).

153. The "[m]ere existence of a competing device does not make that device an acceptable substitute." *TWM Mfg. Co., Inc. v. Dura Corp.*, 789 F.2d 895, 901, 229 U.S.P.Q. 525 (Fed. Cir. 1986), *cert. denied*. A product on the market that lacks the advantages of the patented product can hardly be termed a substitute acceptable to the customer who wants those advantages. *Standard Havens Products, Inc. v. Gencor Industries, Inc.*, 953 F.2d 1360, 1373, 21 U.S.P.Q.2d 1321 (Fed. Cir. 1991), *cert. denied*. If purchasers are motivated to purchase because of particular features available only from the patented product, products without such features would most certainly not be acceptable non-infringing substitutes. *Id.*

154. Also, courts have generally held that an infringer's acceptable substitute argument is of "limited influence" when it [the infringer] ignores those substitutes while selling the patented invention. (Emphasis added). *TWM*, 789 F.2d at 902. This is exactly what Peterson did.

155. In an alternative approach, however, the "entire market value rule" may be used to determine the device for calculating lost profits. In *Beatrice Foods*, the Court stated that the law does not bar the

inclusion of convoyed sales in an award of lost profits damages. *Beatrice Foods Co. v. New England Printing & Lithographic Co.*, 899 F.2d 1171, 1175, 14 U.S.P.Q.2d 1020 (Fed. Cir. 1991).

156. The “entire market value rule” allows for the recovery of damages based on the value of an entire apparatus containing several features, even though only one feature is patented. *Paper Converting Machine Co., v. Magna-Graphics, Corp.*, 745 F.2d 11, 33, 223 U.S.P.Q. 591 (Fed. Cir. 1984).

157. The “entire market value rule” further permits recovery of damages based on the value of the entire apparatus containing several features, when the patent-related feature is the basis for customer demand. See *TWM*, 789 F.2d at 901.

158. The “entire market value rule” is appropriate where both the patented and unpatented components together are analogous to components of a single assembly, parts of a complete machine, or constitute a functional unit. See *Rite-Hite v. Kelly Co.*, 56 F.3d 1538, 1550, 35 U.S.P.Q.2d 1065 (Fed. Cir. 1995).

WILLFULNESS / EXCEPTIONAL CASE

159. In addition to requiring “damages adequate to compensate for the infringement,” Section 284 of the Patent Act authorizes a district court to “increase damages up to three times the amount found or assessed.” 35 U.S.C. § 284.

160. The Federal Circuit has interpreted this provision of Section 284 as requiring a two-step process: “First the fact-finder must determine whether an infringer is guilty of conduct upon which increased damages may be based.” *Jurgens v. CBK, Ltd.*, 80 F.3d 1566, 1570, 38 U.S.P.Q.2d 1397 (Fed. Cir. 1996). “If so, the Court then determines, exercising its sound discretion, whether, and to what extent, to increase the damage award given the totality of the circumstances.” *Id.*

161. “An act of willful infringement satisfies this culpability requirement, and is, without doubt, sufficient to meet the first requirement to increase a compensatory damages award.” *Id.* Thus, once a proper willfulness finding is made, the first step in determining whether damages should be enhanced is complete. *Id.* At that point, the Court need consider only whether, and to what extent, the compensatory damages awarded by the fact finder should be increased, in light of “the egregiousness of the Defendant’s conduct based on all the facts and circumstances of the case.” *Id.*

162. “A potential infringer having actual notice of another’s patent rights has an affirmative duty of care.” *Spindelfabrik Suessen-Schurr, Stahlecker & Grill GmbH v. Schubert & Salzer Maschinenfabrik*

Aktiengesellschaft, 829 F.2d 1075, 1084 (Fed. Cir. 1987). An act of infringement is thus deemed willful when the infringer is aware of another's patent and fails to exercise due care to avoid infringement. *Electro Medical Sys., S.A. v. Cooper Life Sciences, Inc.*, 34 F.3d 1048, 1056 (Fed. Cir. 1994); *Rolls-Royce Ltd. v. GTE Valeron Corp.*, 800 F.2d 1101, 1109 (Fed. Cir. 1986). This standard of care typically requires an opinion from competent patent counsel prior to engaging in any potentially infringing activities. *Underwater Devices, Inc. v. Morrison-Knudsen Co.*, 717 F.2d 1380, 1389-90 (Fed. Cir. 1983). To establish willfulness, Blount must demonstrate by clear and convincing evidence, considering the "totality of the circumstances," that Peterson willfully infringed its patent. *Electro Medical*, 34 F.2d at 1056.

163. The prosecution history of a patent in question is an important element of any competent opinion. *Underwater Devices*, 717 F.2d at 1389-90.

164. A holding of willful infringement is usually sufficient to make a case exceptional and entitles the opposing party to its attorney's fees. 35 U.S.C. § 285 (2002); *Avia Group Intl. Inc. v. L.A. Gear California, Inc.*, 853 F.2d 1557, 1567 (Fed. Cir. 1988).

CONCLUSION

For the reasons set forth above, the Court concludes that Peterson's manufactured products infringe the claims of the '159 patent. Blount is entitled to actual damages from Peterson in the amount of \$429,256. The infringement of Peterson was willful, thus the actual damages are trebled, totaling \$1,287,768. Blount is also awarded prejudgment interest, which shall be calculated on a simple rather than compound basis, on the actual damages of \$429,256 at the rate of 5.0% for the period from December 16, 1999, to August 9, 2002. This is an exceptional case under 35 U.S.C. § 285, thus reasonable attorneys' fees are awarded to Blount. Blount is further awarded post judgment interest, calculated pursuant to 28 U.S.C. §1961, on the sum of the trebled damages and attorney's fees at the highest rate allowed by the law from the date of August 9, 2002, to April 19, 2004, and resuming from the date of the signing of the final judgment. Based upon the fact that infringement causes irreparable harm, an injunction is granted against Peterson.

It is so ORDERED

SIGNED: _____ day of _____, 2004.

JUDGE JERRY BUCHMEYER
UNITED STATES DISTRICT COURT
NORTHERN DISTRICT OF TEXAS

CERTIFICATE OF SERVICE

I hereby certify that a true copy of the Findings of Fact and Conclusions of Law was served on the following counsel of record on August 31, 2004, by first class mail:

Jerry R. Selinger
Jenkins & Gilchrist
1445 Ross Avenue, Suite 3200
Dallas, Texas 75202
214/855-4500 (Telephone)
214/855-4300 (Facsimile)

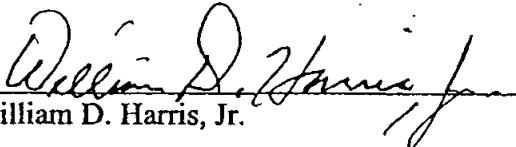

William D. Harris, Jr.